

VM
298
H85++

CORNELL
UNIVERSITY
LIBRARY



BOUGHT WITH THE INCOME
OF THE SAGE ENDOWMENT
FUND GIVEN IN 1891 BY
HENRY WILLIAMS SAGE

Cornell University Library

VM298 .H85

++

Steam vessels and marine engines.



3 1924 030 901 817

olin

Overs

HOWELL'S

Steam Vessels and Marine Engines.

By G. FOSTER HOWELL.

Being descriptions and illustrations of some of the principal Steamships, Steamboats, Steam Yachts and Tugs built in the United States during the past five years, together with regular and special designs of Compound, Triple and Quadruple-Expansion Yacht and Marine Engines, Etc.

WITH A CLOSING CHAPTER ON SAILING SHIPS
AND SCHOONER YACHTS.

PUBLISHED BY THE AMERICAN SHIPBUILDER,
7 COENTIES SLIP, NEW YORK.

vii

21

85++

A.93754

To my Friend

Charles B. Miller,

This work is respectfully dedicated.

PREFACE.

THE object of this book is to provide naval architects, shipbuilders and engineers with a work of reference. No book of this particular kind, showing illustrations of modern American marine engines, has ever been published in the United States. Many American readers are familiar with that excellent British work, "Maw's Marine Engines," by Wm. H. Maw, and if one goes to a technical book publisher for a copy of a publication upon marine engines, he will be offered one of the many English or Scotch works on that subject, as no American book can be found. The same may be said of works upon steamships and yachts. In the preparation of this book I have used several articles and cuts that have previously appeared in the leading marine and mechanical journals of the United States and Great Britain. In this connection I will thank in advance the editors and proprietors of the following papers: *Engineering*, *The Engineer*, London; *The Engineer*, New York; *The Steamship*, Leith, Scotland; *Marine Engineer*, London; *American Engineer*, New York; *American Machinist*, New York; *Power*, New York; *Scientific American*, New York; *Cassier's Magazine*, New York; *Marine Review*, Cleveland, Ohio. New York *Engineering Magazine*. My thanks are also due Fred J. Miller, Prof. J. G. A. Meyer, W. P. Stephens, Thos. Main, M.E., Wm. A. Fairburn, of Bath, Me., and others, for professional assistance (loan of drawings, cuts, etc.) in connection with the publication of this work. If I have omitted the name of any journal or authority from which data or illustrations have been obtained for this publication, it has been quite unintentional. Although the book is intended principally as a work on modern American steam vessels and marine engines, I have, in one or two instances, strayed a little from the plan indicated on the title-page, as is the case in illustrating and describing the old Savannah and the British steamers Campania, Lucania, City of Rome, America, Empress of Japan, etc., but these additions to the work will doubtless be appreciated by shipbuilders and engineers. To make the book more interesting and complete, portraits of some of the designers and builders of the vessels and engines shown in these pages have been added. A few cuts of some well-known marine men are also inserted.

G. FOSTER HOWELL,

Brooklyn, N. Y., January 1, 1896.

921 LAFAYETTE AVENUE.

TABLE OF CONTENTS.

STEAMSHIPS, STEAMBOATS, MARINE ENGINES, ETC.	PAGE.
American Line Steamship St. Louis and Engines.	10
Cunard Line Twin Screw Steamer Campania and Engines.	13
American Steamship Savannah.	13
Old Dominion Line Steamship Yorktown.	18
British Steamship America.	18
Steamship Howard.	18
Twin-Screw Passenger Steamers Northwest and Northland.	21
Steamship El Sol.	26
Twin-Screw Steamer Empress of Japan.	26
Anchor Line Steamship City of Rome.	27
Freight Steamship El Rio.	27
Red D Line Steamship Curacoa.	30
Whaleback Steamer Joseph L. Colby.	30
Whaleback Steamer Charles W. Wetmore.	30
Morgan Line Steamship El Norte.	33
Ellis & Eaves' Induced or Suction Draft.	33
The Sea-Going Steel Tug Nottingham.	34
Twin-Screw Steamer City of Lowell.	36
Engines of Steamer Richard Peck.	37
Engine of Whaleback Steamer Christopher Columbus.	39
New Steamer Cape Ann.	39
Plans and Specifications for an Iron Tug.	42
Fire Boat New Yorker and Engines.	45
Boston and Portland Steamer Bay State.	45
Boston Fire Boat No. 44.	46
Steel Tug W. G. Wilmot, of New Orleans.	47
Stuart's Channel System of Construction.	48
Engine of Steamer Nutmeg State.	49
Chapin's Compound Launch Engine.	50
Burrell-Johnson's Compound Marine Engine.	50
Thropp's Compound Marine Engine.	52
Sloat's Fire and Water-Tube Boiler.	52
Tromblee's Compound Yacht Engine.	53
Compound Engine of Tug Edwin H. Mead.	53
Banshee's Steeple Engines.	57
Forbes' Yacht Engine.	57
Hayes' Compound Marine Engine.	57
Smit's Marine Engine.	57
Seabury's Triple-Expansion Yacht Engine.	58
Wheeler Surface Condenser.	60
Volz's Patent Combined Surface Condenser and Feed-Water Heater.	62
Wells' Balanced Compound and Quadruple Expansion Engine.	62
Chase's Quadruple-Expansion Marine Engine.	66
Clark's Compound Yacht Engine.	69
Davis-Farrar Yacht Engines.	69
Joy Valve Gear.	72
Marshall's Valve Gear.	73
Canfield's Patent Balance Valve.	74
Bonner's Patent Compound Balance Valve.	74
Sullivan's Triple-Expansion Yacht Engine.	75
Engines of the Yacht Neaira.	76
Three-Cylinder Compound Engines of Steamer Pleasure.	79
Donegan & Swift's Launch Engine.	81
Lumgair's Quadruple-Expansion Engine.	81
Steeple Compound Engines of Ferryboat Cincinnati.	82
Coller's Yacht Engine.	85
See's Quadruple-Expansion Engines in Tug El Toro.	85
Riley & Cowley's Launch and Yacht Engines.	87
Paul's Patent Reversing Gear.	88
Compound Engines of the Hoboken Ferryboat Bremen.	89
Oscillating Engine of the Connecticut.	91
Oscillating Engines.	93
Compound Beam Engines of the Honan.	93

Beam Engines.	PAGE.
Setting the Valves of Beam Engines.	94
Morris' Compound Marine Engine.	97
Compound Engine of Steam Yacht Dream.	97
Quadruple-Expansion Engines of the Steamship Kensington.	97
Kingdon's Patent Engine for Steam Launches.	101
Haug's Compound Marine Engine.	101
Composite Steam Light Vessel.	103

STEAM YACHTS.

Composite Auxiliary Steam Yacht Satanella.	104
Steam Yacht Free Lance.	104
Steam Yacht Formosa.	107
Steam Yacht Peregrine.	108
Twin-Screw Steam Yacht Hirondelle.	109
Steam Yacht Valiant.	109
Steam Yacht Marietta, No. 1.	110
Auxiliary Steam Yacht Semiramis.	112
Wooden Steam Yacht Chetolah.	113
Wooden Steam Yacht Reverie.	113
Steam Yacht Oneonta.	114
Steam Yacht Wapiti and her Engines.	117
Steam Yachts Built by Wm. Cramp & Sons.	120
Steam Yacht Eleanor.	121
Steam Yacht Rex.	121
Three Fastest Steam Yachts.	121
Steam Yacht Alcedo.	123
Steam Yacht Dungeness.	126
Wooden Steam Yacht Clermont.	126
Steam Yacht Restless.	128
Wooden Steam Yacht Linta.	130
Wooden Steam Yacht Calypso.	130
Steam Yacht Embla.	130
Auxiliary Steam Yacht Wild Duck.	132
Fast British Steam Launch Wild Duck.	134

SAILING SHIPS, SCHOONER YACHTS, ETC.

Clipper Ship Morning Light.	134
Celebrated Clipper Ship Young America.	136
Wooden Ship Aryan.	137
First American Steel Sailing Ship.	138
Packet Ship Dreadnought.	142
American Wooden Shipentine Roanoke.	144
Four-Masted Bark Olympic.	144
American Steel Bark.	144
The Largest Sailing Vessel in the World.	145
Five-Masted Ship Maria Rickmers.	146
Steel Shipentine Somalie.	145
Four-Masted Ship Falls of Earn.	147
British Shipentine Afghanistan.	147
R. P. Joy's Schooner Yacht Pilot.	147
Auxiliary Steam Yacht Utowana.	148
Steel Schooner Yacht Lasca.	148
Reefing Topsails.	152
French Schooner Yacht Velox.	151
Pilot Boat for Fernandina, Fla..	151
Swedish Schooner Yacht Sveridge.	158
The America.	158
Combined Cruising and Racing Schooner.	159
Five-Masted Schooner Gov. Ames.	159
Manton's Improved Windlass for Fishermen.	159
Providence Fisherman's Windlass.	162
Howell's Automatic Wave Lubricating Life Buoy.	163
Captain William Tumbridge.	163
Tacking Ship Off Shore.	167

PORTRAITS.	PAGE.	PAGE.	
Wm. H. Webb, America's Greatest Wooden Shipbuilder; Founder of Webb's Academy and Home for Shipbuilders, Fortham Heights, N. Y.	169	Frank B. King, Engineer and Naval Architect, Superintendent Marine Department, Maryland Steel Co., Sparrow's Point, Darwin Army, Inventor and Builder of the Army Water-Tube Boiler, Providence, R. I.	177
Wm. Cramp, Founder of the Cramp Shipbuilding Works, Philadelphia, Pa.	169	Henry Konitzsky, Naval Architect and Engineer, Philadelphia	178
John Roach, Chester, Pa., the late Iron Shipbuilder	170	Richard P. Joy, Detroit, Mich., the Patriot, and Friend and Advocate of American Shipping Interests	179
Chas. H. Cramp, President of the Wm. Cramp & Sons Ship and Engine Building Co.	171	Chas. B. Miller, Founder of the Magnolia Metal Co., New York,	179
J. C. Henderson, Ex-Chief Engineer General Electric Co., (Edison Systems), New York	172	Chas. Ward, of Charleston, W. Va., the Inventor and Builder of the Ward Boiler	179
George W. Melville, Engineer-in-Chief, United States Navy	173	E. E. Roberts, of Red Bank, N. J., Inventor and Builder of the Roberts Water-Tube Boiler	179
Irving M. Scott, President of the Union Iron Works, San Francisco, Cal.	173	Chas. E. Hyde, Designing and Constructing Engineer, Bath (Maine) Iron Works	180
Clement A. Griscom, President International Navigation Co., Philadelphia, Pa.	173	Sinclair Stuart, Ship and Engineer Surveyor to the United States Lloyds, etc., New York	180
Geo. W. Dickie, Manager Union Iron Works, San Francisco, Cal.,	174	Hobert Canfield, Master Mechanic Pennsylvania R. R. Shops, Hoboken, N. J.	180
Capt. George L. Norton, Editor New York <i>Marine Journal</i>	174	Sam'l J. Clarke, Superintending Engineer Providence & Stonington Line, New York	180
John W. Collins, Engineer-in-Chief U. S. Revenue Marine Service, Washington, D. C.	175	James S. Doran, Superintending Engineer International Navigation Co., New York	181
W. T. Sylven, Designing and Superintending Engineer U. S. Lighthouse Service	175	George Clarke, Assistant Superintendent, Engineer American and Red Star Lines, New York	181
Horace See, Engineer and Naval Architect, New York	175	John H. Dialogue, Iron Shipbuilder, Camden, N. J.	182
W. H. Jacques, of See & Jacques	175	Gustav Hillmann, Naval Architect, Brooklyn, N. Y., Designer of the Steam Yacht Nourmahal, etc., etc.	182
George V. Sloat, Superintending Engineer, Old Dominion Line, New York	176	T. Jackson Shaw, Chief Engineer the Harlan & Hollingsworth Co., Wilmington, Del.	182
Chas. D. Mosher, Engineer and Naval Architect, New York	176	James Dredge, of Messrs. Maw & Dredge, Editors <i>London Engineering</i>	183
E. Platt Stratton, Chief Engineer Surveyor to the Record of American and Foreign Shipping; Consulting Engineer by Appointment to the Board of Underwriters, New York,	176	Capt. Wm. Tunbridge, Proprietor Hotel St. George, Brooklyn, N. Y.	184
Sommers N. Smith, M.E., Superintendent Newport News (Virginia) Shipbuilding and Dry Dock Co.	176	Capt. I. J. Merritt, of the Merritt Wrecking Organization, New York	184
W. F. Durand, Professor of (Marine) Engineering, Sibley College, Cornell University, Ithaca, N. Y.	177	Philip Hichborn, Chief Constructor, U. S. Navy.	184
John Haug, Engineer and Naval Architect, Philadelphia, Pa.	177		
Chas. R. Hanscom, Naval Architect, Superintendent Bath (Maine) Iron Works.	177		



STEAMSHIP ST. PAUL.

Erratum.

In the description of the engines of steam yacht Columbia, page 121, a typographical error occurred. It should read:

“There are two low-pressure cylinders, each 34 inches in diameter, the same as in the dynamite gunboat Vesuvius. The stroke of pistons is 20 inches.”

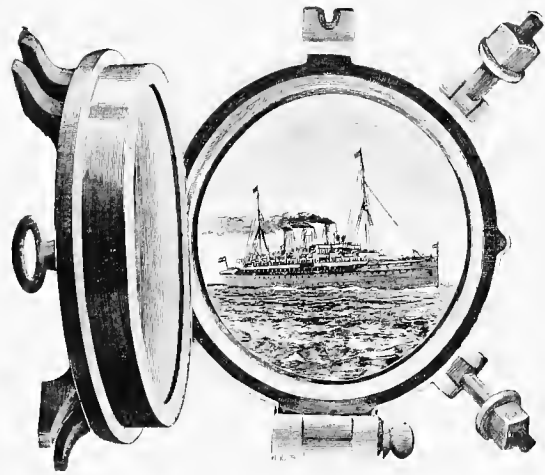

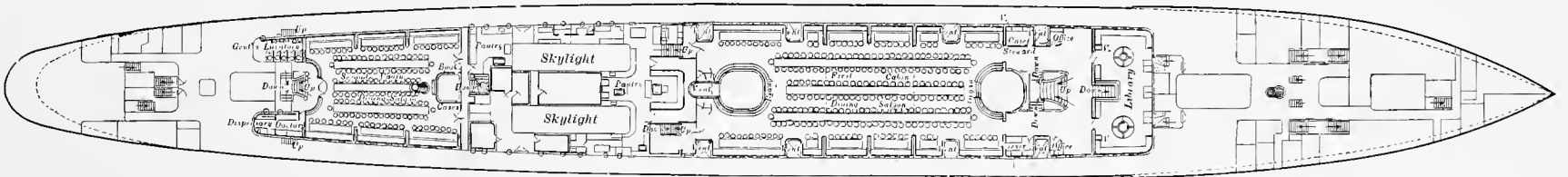
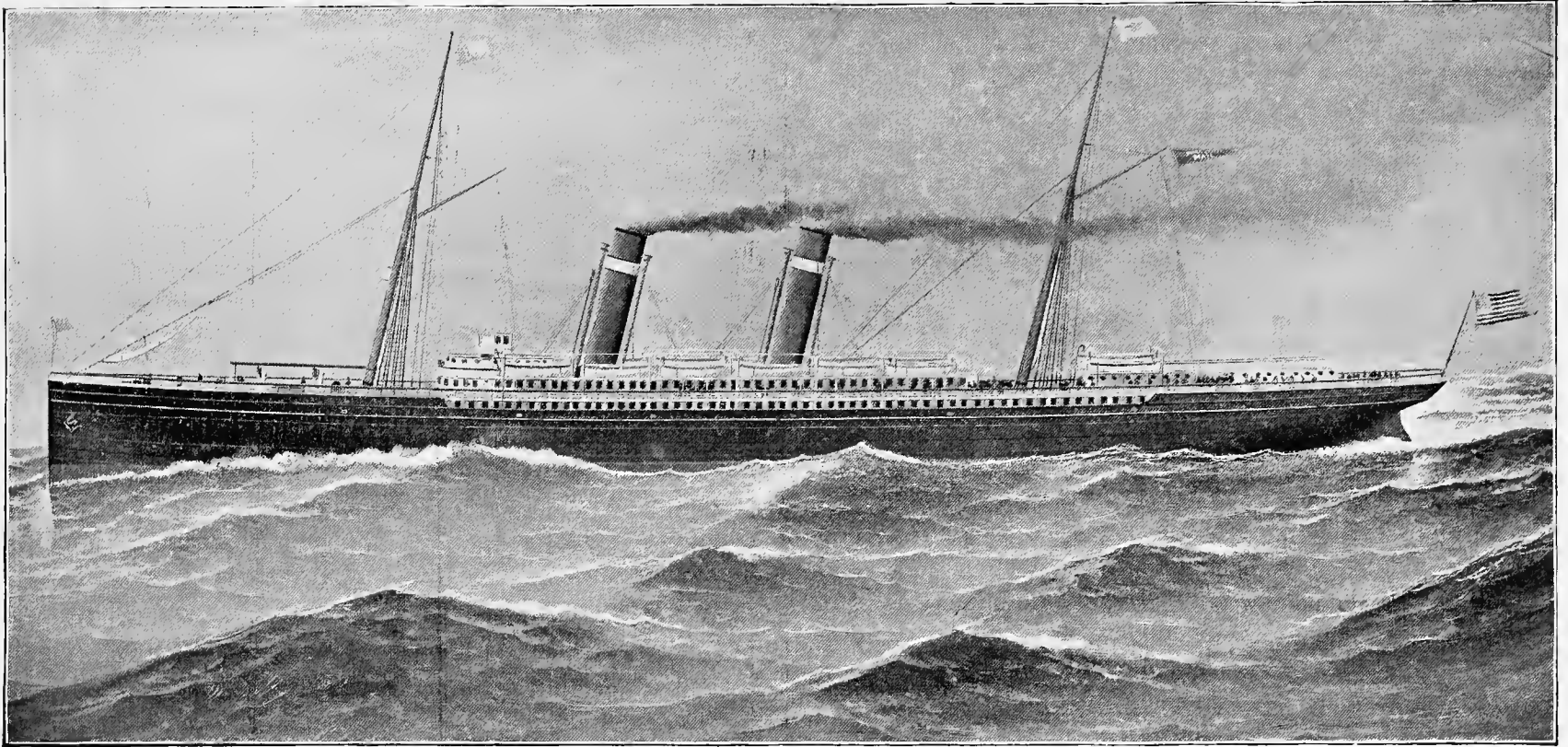
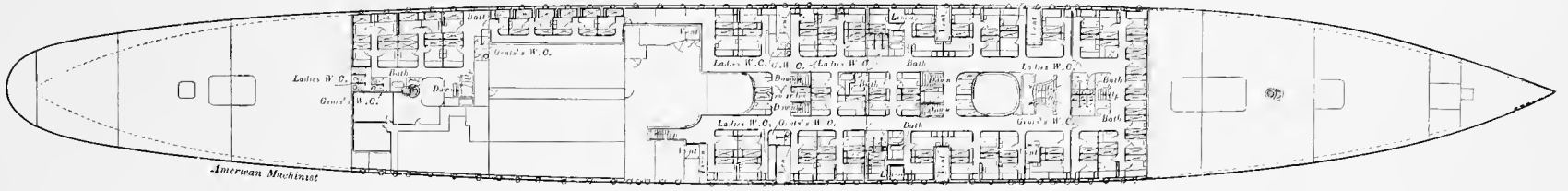

THE AMERICAN LINE TWIN-SCREW PASSENGER AND MAIL STEAMER ST. LOUIS.—By the Wm. Cramp & Sons Ship and Engine Building Co.

The American Line Steamer St. Louis and Engines.

The dimensions of the vessel are as follows: Length over all, 554.2 feet; length between perpendiculars, 535.8 feet; extreme beam, 63 feet; gross tonnage, 11,629.21 tons; net tonnage, 5,893.73 tons. The St. Louis and St. Paul are sister ships. Both were built by Wm. Cramp & Sons.

ENGINES OF THE AMERICAN LINE STEAMER ST. LOUIS.

The main engines are of the quadruple-expansion type, with six cylinders working on four cranks, an arrangement designed by the Cramps. There are two high-pressure cylinders, and each of these is placed over one of the two low-pressure cylinders. The tandem cylinders are at the forward end, the arrangement being high-pressure and low-pressure working on the first crank, the same working on the second crank, the second intermediate on the third crank, and the first intermediate on the fourth crank. The diameters of the respective cylinders are: two high-pressure, 28 $\frac{1}{2}$ inches; first intermediate, 55 inches; second intermediate, 77 inches; two low-pressure, 77 inches. The stroke in each case is 5 feet. The cylinders are each separate castings, and are supported on A-frames at back and front, the condenser and its pumps being separate and placed in the wings of the ship. The supporting frames are cast in two parts, each part having three sides only, with flanges to the outside for bolting together. The inside is thus entirely open, so that the soundness of the casting is apparent. The cylinders are braced longitudinally by cast-iron girders of box section, which also extend between the forward and aft cylinder and the ship's bulkhead, so that there is little tendency to work. These bulkheads are specially stiffened by girders 2 feet deep, built of plates and angle bars. Each high-pressure cylinder is carried 24 inches above the low-pressure cylinder on cast-iron frames on either side, and this clearance enables a manhole to be provided on the top of the low-pressure cylinder to admit of examination, etc. The main stop valve is in the engine-room, on the same level as the high-pressure cylinders; and the inlet to the high-pressure cylinder valves is controlled by a balanced piston throttle valve on the main pipe. The steam pipes, it may be said, are all of steel, lap-welded, with double-rieveted flanges, and the largest is 20 inches in diameter.

Piston valves of the Thom's balanced type are fitted throughout, and they are operated by the usual double-eccentric link motion, the bent rod being for the astern motion. There are two valves for the low-pressure cylinders. The spindle of the high-pressure cylinder valve is worked from the low-pressure valve crosshead through a bell-crank lever.

The second intermediate and the two low-pressure cylinders only have jackets, and these drain into water taps which discharge into the hot-well tank. Outside all the cylinders are coated with asbestos, hair-felt, and covered with sheet steel. Cramp's metallic packing is used throughout. It is somewhat similar to the United States packing, with cast-iron rings compressed by a spiral spring. The clearance in the cylinders is on the top of the pistons $\frac{1}{2}$ inch, and below, $\frac{5}{8}$ inch. The piston-rods of the high-pressure cylinders are 6 inches in diameter, and in the other cylinders 8 $\frac{1}{2}$ inches. The connecting-rod is fully twice the length of stroke, 11 feet 3 inches centers, and it is 8 $\frac{1}{2}$ inches in diameter at top, and 10 inches at bottom. The connecting-rod at top is not forged with the usual U-end for the crosshead pins. The crosshead connection is built up.

The top of the rod is squared to a T-piece, with a hole bored through the two heads. On the bottom of the crosshead itself, at either side, there is a forged projection, which is screwed and passed through the holes and bolted. In other words, the crosshead brasses have a steel T-piece with pin forged to the bottom which passes through the holes on the top of the connecting-rod. Slipper guides for the crosshead are fitted to one side of the framing. There is a steel flange fitted on either side of the column face, and the slipper works inside it. Between the back of the crosshead and the other frame there is a small gangway to admit of inspection, and to economize weight a hole is bored through the crosshead brasses, which also have the usual piece for adjustment.

The crank shaft is 21 inches in diameter, the crank pins 22 inches, the bolts being 5 inches at the bottom of the thread. The cranks themselves are 16 inches broad, the length of pin being 31 $\frac{1}{2}$ inches, and there is a 6-inch hole through the cranks and pins. The bearings are 26 inches long, and are of cast steel filled with Parson's metal. They are bolted down with 4 $\frac{1}{2}$ -inch bolts, and in the bottom water is circulated. Here it may be stated that the bed-plate is of cast-iron box-section, 3 feet 4 inches deep, and 4 feet 7 inches at the center, the center part, instead of being flat, being dished to the extent of 1 foot. The bases of the standards are fitted to the dished part of the bed-plate as well as the flat portion, so as to tend to obviate the radial "working," which sets up torsional vibration and strains.

The thrust shaft is 21 inches in diameter, and solid, the diameter over thrust rings being 33 inches. There are 13 horseshoe collars, each 2 $\frac{1}{2}$ inches thick, and the surface on the ahead side is 6,616 square inches. The length of the thrust shaft is 14 feet, and it is secured to the bed-plate of the engines. The horseshoe rings are adjustable by a horizontal screw with two nuts for each side, which greatly facilitates the removal of any ring. The turning wheel is immediately aft of the thrust shaft. The engine has two cylinders, 8 inches in diameter by 8 inches stroke. The thrust shaft, by the way, is placed in a recess, and over it, with entrance from an upper platform, is the dynamo-room.

The propeller or line shaft is 19 inches in diameter, also solid. It is fitted in lengths of 23 feet, with bearings 14 feet apart. These bearings are 2 feet long, and have cast-steel bobbies, filled with Parson's white metal. There is fitted to the after length of the shaft a portable coupling. It is in halves, and through each half there is a longitudinal feather 5 inches wide and 2 $\frac{3}{4}$ inches deep. The ten bolts were put through the coupling when at a high temperature, the subsequent contraction giving greater binding to obviate slip. This arrangement, which is not usual, is to facilitate the drawing of the shaft for repair. The feathers running longitudinally through each half of the coupling would not have prevented the shaft from backing out when the engine was going astern, and to overcome this possibility, grooves 1 inch deep were turned in the shaft, forming collars, which engage in collars and grooves on the coupling. There is no outboard shaft, the framing and plating of the ship being bossed out in the same way as in most high-speed twin-screw merchant steamers now. The stern shaft, which is 21 inches in diameter, is covered with a liner 1 $\frac{1}{2}$ inches, working in lignum-vitæ bearings, constructed in the old style in strips 3 $\frac{1}{2}$ inches broad and 1 inch deep, the division between the strips allowing water to circulate. The

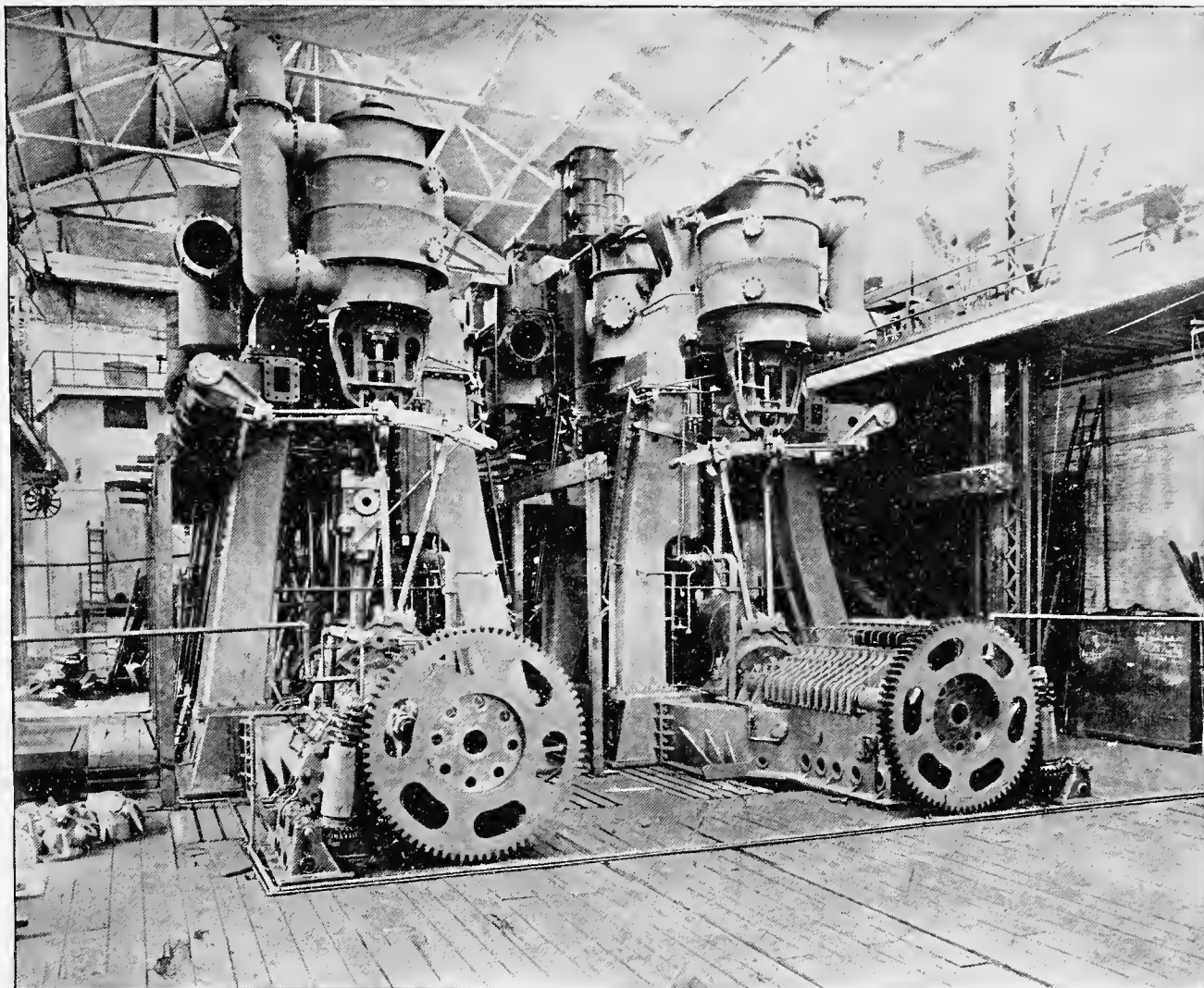

QUADRUPLE-EXPANSION ENGINES OF STEAMER ST. LOUIS.—Built by Wm. Cramp & Sons.

stern gland is light, but is packed with Tupper's machine-plaited flax packing. The bosses of the propellers are of steel, with three blades of Parson's bronze, and these, for the present, are set at a pitch of $27\frac{1}{2}$ feet.

The condensers are, as we have already stated, separate from the main engines. They are 7 feet 2 inches inside diameter, and the tubes, which are of seamless brass, are $\frac{3}{4}$ inch in diameter and 16 feet $8\frac{3}{8}$ inches long. There are six stay rods, and the tubes are supported at two intermediate points between the tube plates. The total condensing surface is 26,170 square feet. The air-pumps are also placed in the wings of the ship. There are four for each condenser, and they are of the Worthington type, with steam cylinders 26 inches in diameter and 20 inches stroke. There are 8-inch valves to each of the four buckets.

We come now to the boilers, which work at 200 pounds

pressure, having been tested to 300 pounds by water pressure. There are six double-ended and four single-ended boilers, each 15 feet $7\frac{1}{2}$ inches in diameter, while the former are 20 feet long, and the latter are 10 feet $4\frac{1}{2}$ inches. The shell plates are 19-16 inches in thickness, and are quadruple riveted with $1\frac{1}{2}$ -inch rivets. The front plate is flanged inwards. There are four furnaces in each end, and these have each separate combustion chambers. Thus there are in all 64 furnaces. These are of Fox's corrugated type, and in accordance with latest practice they are slightly reduced in diameter towards the back, so that they may be readily withdrawn for repairs without injuring the front of the boiler. The flues are 3 feet 3 inches in diameter, of 19-32 inch thickness of metal, and the furnaces, which have ordinary fire bars, are 6 feet $10\frac{1}{2}$ inches long. There are 416 tubes in the single-ended, and 832 in the double-ended boilers, the total number of tubes in all boilers

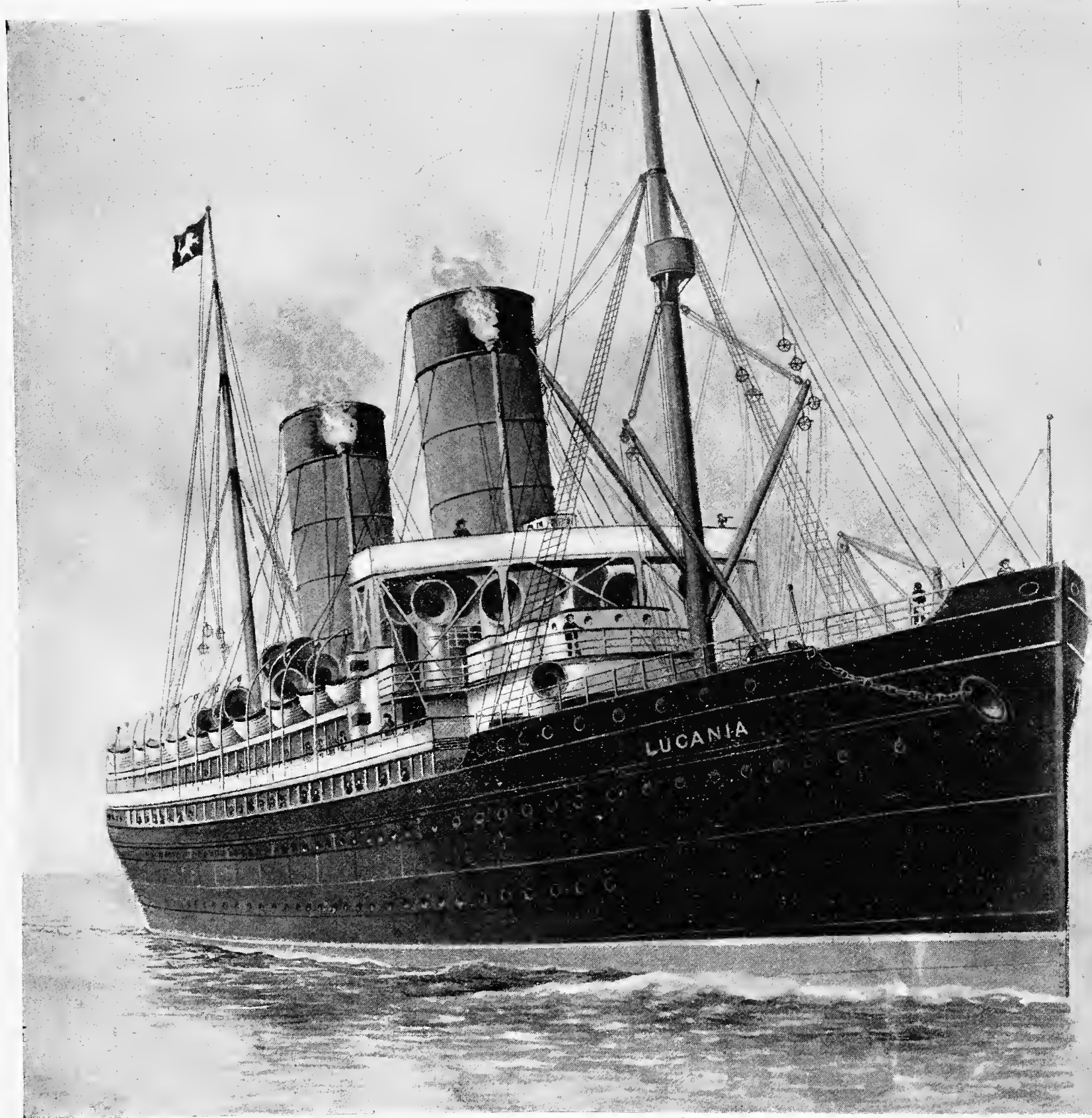

being 6,656. The number of stay tubes is 328 in each double-ended boiler. The fire tubes are $2\frac{3}{4}$ inches in external diameter, and the thickness of metal 11 B. W. G., while the stay tubes are $2\frac{3}{4}$ inches in diameter and $\frac{1}{4}$ inch thick, the distance between the tube sheets being 7 feet. The tubes, by the way, are fitted with spiral retarders which have given good results in causing the hot gases to pass in a helical course through the tubes, and thus insure prolonged contact with the surface. The tube plates are $\frac{5}{8}$ inch thick. The diameter of the combustion chamber stays at the smallest base is $1\frac{3}{4}$ inches for the outside row, and $1\frac{3}{8}$ inches for the inside row; by 7 inches pitch. The total grate area is 1,144 square feet, and the total heating surface 40,320 square feet. There are six safety valves on the double-ended, and four on the single-ended boilers, all of 4 inches diameter.

The installation of boilers is equally divided between two water-tight compartments. There are thus three double-ended and two single-ended boilers in each, and the installation is worked under Howden's system of forced draught, by which the air is heated before being passed into the furnace. The stokehold is open, and is specially well ventilated. It is divided longitudinally in the middle line by a thin plating or screen, which comes to within 6 feet of the heads of the stokers. The down air shaft is on the one side of this screen, and the other side is closed in at the top, excepting the in-take for the forced draught fans. Thus the current of air is brought as near the stoking floor as possible. There is bunker capacity for carrying 2,500 tons of coal, which will just equal eight days' consumption.

The Cunard Line Twin-Screw Steamer *Campania*.

This splendid specimen of British naval architecture and marine engineering was constructed at the Fairfield Shipbuilding Works, Govan, Glasgow, and is a sister ship to the *Lucania*. These works were founded by the late John Elder. The *Campania* has two sets of triple-expansion engines of 15,000 horse-power each. The dimensions of the hull are: Length over all, 622 feet; between perpendiculars, 600 feet; breadth, 65 feet; tonnage, 12,950. The plates are of steel, 25 feet long, 6 feet wide and 1 inch thick. Steam is supplied from twelve main double-ended boilers, 18 feet in diameter and 17 feet long, each having eight corrugated furnaces, giving a total grate surface of 2,250 square feet. Each boiler weighs nearly 100 tons. The two funnels, it may be added, are from their lowest section 120 feet high, or about the height of the Eddystone lighthouse. They are each 21 feet in diameter. The boilers are in two batteries, separated by a coal bunker 65 feet in length. Additional coal bunkers are placed over and around the boilers to protect them from shot in case of war. Natural draught is used, ventilation being provided by means of immense ventilators mechanically driven. The boiler plates are $1\frac{1}{2}$ inches in thickness. The bulkhead that divides the two engine-rooms is the only longitudinal bulkhead in the ship.

The engines receive steam at 165 pounds pressure and are triple-expansion, having five cylinders—two high-pressure, 37 inches in diameter; one intermediate, 79 inches in diameter; and two low-pressure cylinders, 98 inches in diameter, with a stroke of piston in each case of 69 inches. These cylinders are arranged with one high-pressure cylinder over each low-pressure

cylinder, working tandem on the same rod, and the intermediate cylinder between them. These work three cranks, set at angles of 120° from each other, the crank shaft being 26 inches in diameter. On her trial trip, with 165 pounds pressure and 28 inches vacuum, at 84 revolutions per minute, the two engines indicated 31,050 horse-power, and developed an average speed of 23.18 knots. The engines are of a peculiar type, designed to reduce the space into which engines of great power may be compressed. If the old-fashioned plan of using three cylinders for triple-expansion had been followed, it was seen that the low-pressure cylinders in a case of 15,000 horse-power would have been greater in diameter than existing machinery could produce with accuracy, or than space could be provided for in the vessels it was proposed to drive. The plan adopted, therefore, was to divide both the high-pressure and the low-pressure cylinders into two, to place a small high-pressure cylinder on the top of a low-pressure, and to put the pistons in each case on the same piston-rod and work them tandem fashion. The intermediate cylinder stands alone in the middle of the series, and the piston-rods of each connect with one of the three cranks of the screw shaft. This arrangement got rid of another difficulty. Formerly there appeared from the top of the low-pressure cylinders a guide-rod, designed to prevent the large circumference of the piston in these large cylinders from wearing unevenly; but, with steam pressure of over 100 pounds, this guide-rod was a constant source of difficulty. It is by this five-cylinder arrangement entirely superseded. The piston of the high-pressure cylinder acts as a guide-rod for the lower and larger diameter, and the steam is entirely boxed in. The piston, piston-rods and connecting-rods of these engines weigh about 120 tons; they have a stroke of 69 inches, and at 81 revolutions—the normal speed of the engines—this enormous weight is moved at a distance of nearly 1,000 feet each minute. The crank shaft is 26 inches in diameter, and each of the three interchangeable parts weighs 27 tons and is some 27 inches in diameter. These, with the thrust shaft 14 feet long, make up a total of 110 tons for each crank shaft. The propeller shaft is 24 inches in diameter, and is fitted in lengths of 24 feet, each length having two bearings; and the thrust block is fitted with fourteen rings. The propeller, which is placed on the end of the shaft without any interior overhanging bracket, is three-bladed, and each blade weighs eight tons, or forty-eight tons in all.

American Steamship *Savannah*.

The first voyages of a steamship across the Atlantic were made in 1819 by the *Savannah*, an American vessel carrying the American flag and manned by an American crew. It seems eminently proper to preserve an authentic record of the event connected therewith in our national archives, particularly since the original log-book of these voyages is in the collection of the U. S. National Museum. So far as is known, no reliable drawings of the *Savannah* are in existence. A lithograph, faulty in many of the details of the hull, sails and rigging, has been the basis of all previous illustrations of this historic vessel. In view of this fact, a corrected drawing, based upon early descriptions of this vessel, together with such details of description as are extant, has been made by C. H. Hudson,

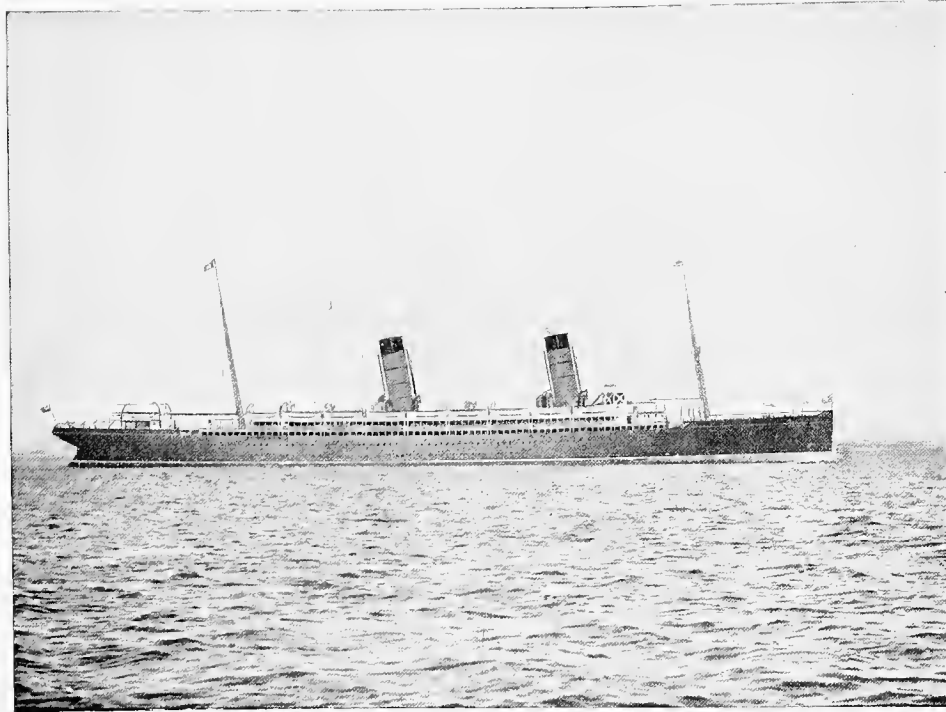

THE CAMPANIA.

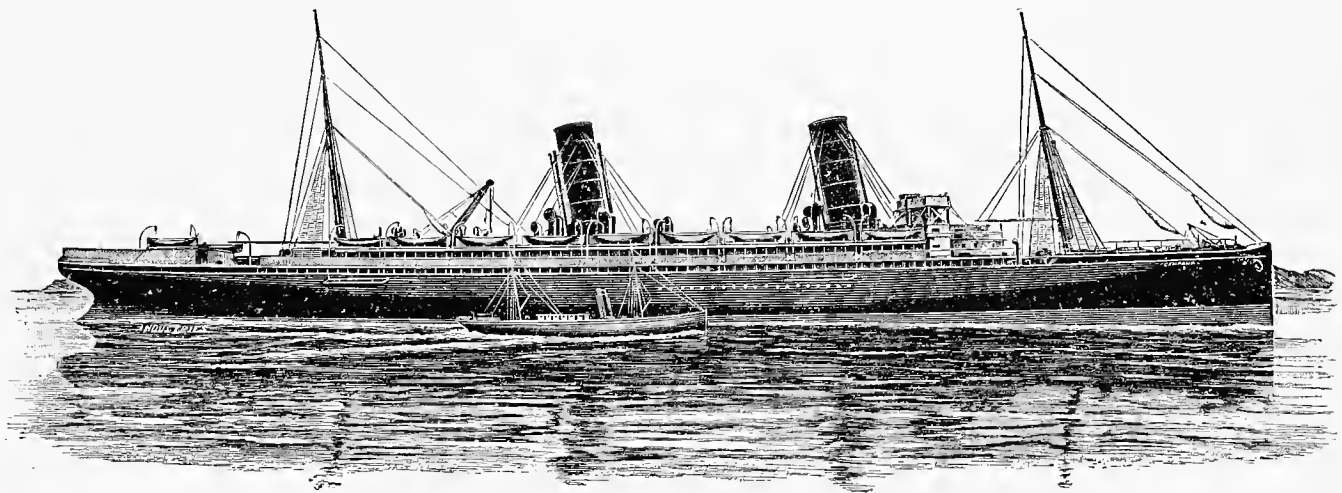

THE CUNARD TWIN-SCREW STEAMER CAMPANIA.

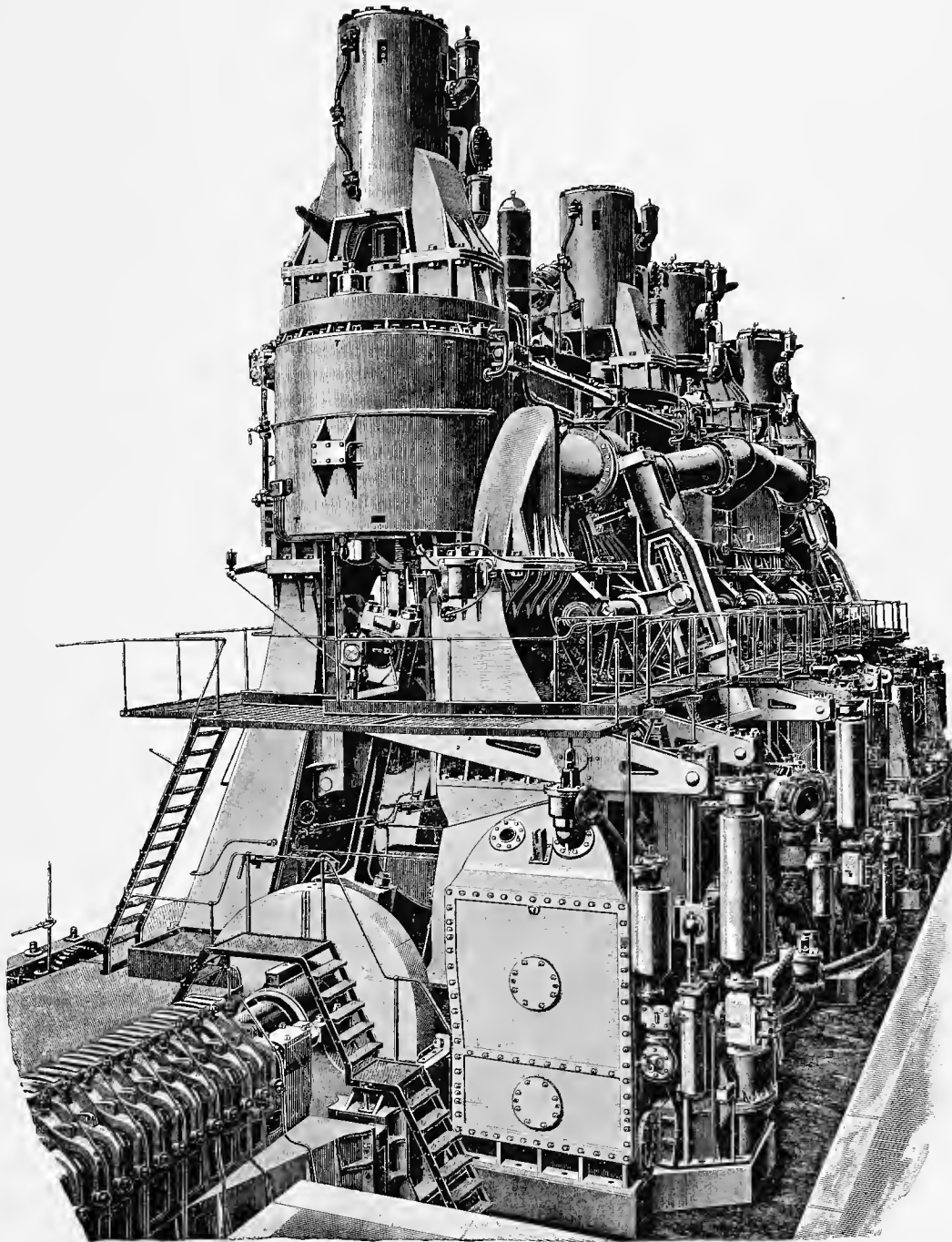

TRIPLE-EXPANSION ENGINES OF THE CAMPANIA.

under the supervision of Captain J. W. Collins, ex-U. S. Commissioner of Fish and Fisheries, and Curator of the Section of Naval Architecture in the National Museum, Washington, D. C., whose familiarity with the history of naval architecture and the construction of sailing vessels, contemporary with the Savannah, has enabled him to correct many errors and supply the deficiency in the original lithograph.

The following notes, explanatory of certain technicalities in the drawing, have been furnished by Captain Collins: The history of the Savannah shows that she was designed, originally, for a sailing ship; that her construction was already well advanced when it was determined to make a steamship of her, and that she was rigged as a sailing vessel, steam apparently being considered chiefly auxiliary, to be used principally in calms or with light or head winds. The contemporaneous lithograph and all other illustrations of this famous vessel, represent her as a full-rigged ship, with, however, no sails loftier than topgallant sails, with her mainmast and foremast more widely separated than on ships designed for sail alone, and having a round stern. The sailing ships of that period were usually rigged very loftily, commonly carrying royals, while the almost universal type of stern was square. Nevertheless, it is reasonable to suppose that those having charge of the rig and equipment of the Savannah may have felt that light sails, which could be used only in moderate winds, would not be necessary on a ship having steam as an auxiliary motive power, and that her stern was round is by no means impossible. Therefore, not having any authority for changing these details, they have been represented as in the original lithograph; the relative positions of the masts, smokestack, and wheels are also retained. In all details of hull and rig, with the exception of those mentioned, the effort has been to produce a ship of the period when the Savannah was built, and special attention has been given to the details of sails and rigging, points in which all illustrations of this ship, previously extant, were markedly erroneous and unsatisfactory. The ship is represented as close hauled on the starboard tack, in a fresh breeze, with her paddle-wheels in motion. She is rising on the slope of an Atlantic swell, leaning well over to the breeze, while the yeasty wave, curling away from her bow and sweeping in foam along her sides, indicates that she is moving at a good speed. The fore-top-gallant sail has just been clewed up and two seamen are seen climbing the rigging to furl the canvas, while in the distance another ship is in sight, running before the wind with square yards.

The Savannah was a full-rigged ship of 350 tons burthen, and was built at Corlear's Hook, New York, by Francis Fickett and David Crocker, from designs of Wm. Scarborough, of Savannah, Ga. At first she was intended to be used as a sailing packet between New York and Havre, France. The keel was laid in 1818, and the vessel was launched August 22 of the same year. While the Savannah stood upon the stocks she attracted the attention of Capt. Moses Rogers, who had been associated with Fulton and Stevens in commanding several of the early steamboats. It was through his exertions that Scarborough & Isaacs, a wealthy shipping firm in Savannah, were induced to purchase the vessel and fit her with engines with a view of giving to that city, which was then one of the most important American seaports, the credit of being the first to inaugurate a transatlantic steamship line. The Savannah was equipped with one inclined, direct-acting, low-pressure engine

of 90 horse-power, the diameter of the cylinder being forty inches and the stroke 5 feet. Her engine was built by Stephen Vail at Speedwell Iron Works, near Morristown, N. J. The boilers were built at Elizabeth, N. J., by Daniel Dod or Dodge. The paddle-wheels consisted of eight radial arms, held in place by one flange, and were arranged to close together like a fan. They were furnished with a series of joints so that they could be detached from the shaft and taken in on deck when storm or other circumstances require it. Her shaft had a peculiar joint at each end arranged for the purpose. The wheelhouse was made of canvas, stretched over an iron rim. It is unfortunate that no detailed drawing or accurate description of the wheels or machinery is in existence. The vessel carried 75 tons of coal and 25 cords of wood. The total cost was about \$50,000, including engines and all rigging.

An account book containing a record of the original charges made against the Savannah for machinery, etc., by the proprietors of the Speedwell Iron Works, is now in the possession of John Lidgerwood, of No. 26 Liberty Street, New York. In addition to the engines the vessel carried the same complement of spars and sails as a sailing ship of that period, with the exception of royal masts. The hull and rigging were constructed under the direction of Stevens Rogers, afterwards sailing master of the vessel. The most important difference noticeable in her rigging, so far as can be determined by engravings extant, is that her mainmast stood considerably farther aft than it would have been placed on a ship intended to be propelled only by sails. This modification of the rig was doubtless made to obtain more space between the foremast and the mainmast, so that the boilers, engines and coal bunkers could be located nearly in the middle of the ship and still be forward of the mainmast.

The New York *Mercantile Advertiser*, March 27, 1819, contained the following: "The new steamship Savannah is to leave our harbor to-morrow. Who would have had the courage 20 years ago to hazard a prediction that in the year 1819 a ship of 300 tons burden would be built in the port of New York to navigate the Atlantic propelled by steam? With admiring thousands have we repeatedly viewed this prodigy." Moses Rogers, the captain, and Stevens Rogers, the first officer (or sailing-master, as he was called), although bearing the same surname, were not related by ties of blood. They were, however, brothers-in-law, the latter having married a sister of the former. Both men were born in New London, Conn., where the latter died in August, 1868. The well-known captain was also chief engineer. The voyage to Liverpool, England, was made in 22 days, 14 of the 22 under steam. She then visited several of the continental ports of Europe before returning to the United States.

The great fire in Savannah in January, 1820, brought pecuniary embarrassment upon her owners, who, failing in their efforts to sell the vessel to the Government, were compelled to dispose of her elsewhere. Her engines were removed and sold to the Allaire Iron Works, of New York, for \$1,600, and put to other purposes. In the Crystal Palace exhibition of 1856, the 40-inch cylinder was exhibited as an historical relic in connection with the log-book. After the vessel was divested of her engines, she ran between New York and Savannah as a sailing packet for several years. She ran ashore on Long Island and went to pieces in 1822, a few months after the death of her commander.



THE AMERICAN STEAMSHIP SAVANNAH.—The first ship to cross the Atlantic under steam, 1819.

The Old Dominion Line Steamship Yorktown.

The steamer shown in the cut represents the Yorktown (and her sister ship, the Jamestown), which were constructed in 1894 by the Delaware River Iron Shipbuilding & Engine Works, Chester, Pa., for the New York and Norfolk, Va., route. These vessels are 322 feet in length over all, 300 feet keel, a beam of 40 feet, and 26 feet 6 inches depth of hold. The engines are of the triple-expansion condensing type, with cylinder diameters of 28, 44 $\frac{1}{2}$ and 73 inches for the high, intermediate and low-pressure, respectively, and a common stroke of 54 inches. The propeller is of the sectional type, four-bladed, and made of manganese bronze. These ships are

pool and New York in the passenger and freight trade. The most remarkable fact in connection with this ship is that her model was made by an American, Andrew Read, now Superintendent of Webb's Academy and Home for Shipbuilders, Fordham Heights, N. Y., at the solicitation of F. W. J. Hurst, who was then Treasurer of the New York Yacht Club. The dimensions of this steamship are: Length, 450 feet; beam, 51 feet; depth of hold, 38 feet 6 inches; with a gross tonnage of about 6000. She cost nearly £200,000. Her cargo spaces measure a trifle over 3100 tons in cubic feet, but she will carry about 2000 tons dead weight and her coal. The America was sold to the Italian Government several years ago, to be used as a cruiser.

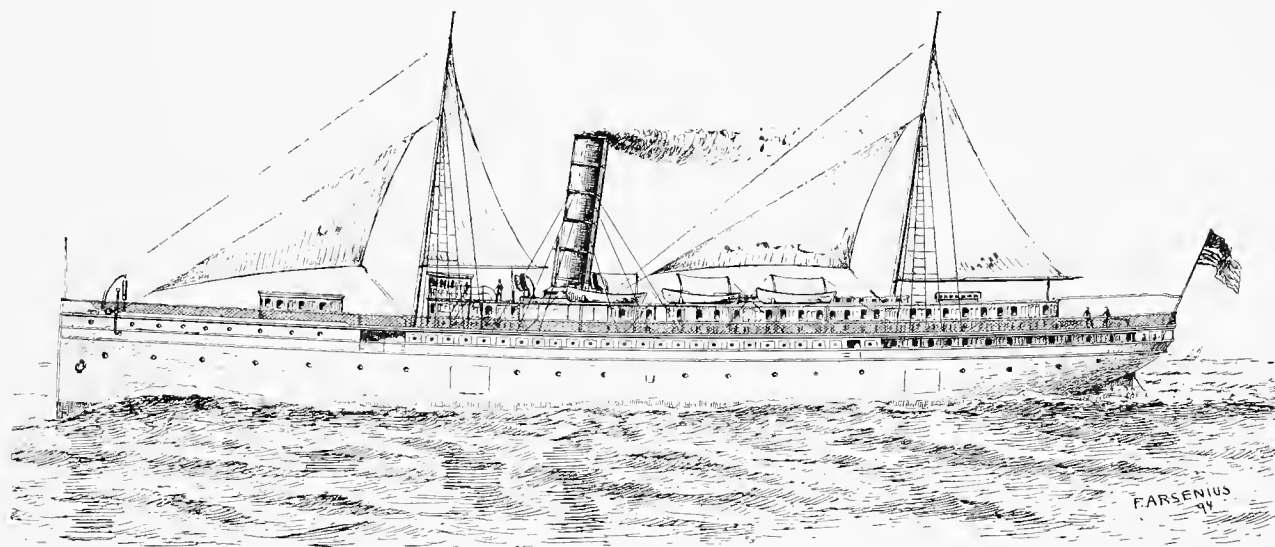

THE OLD DOMINION LINE STEAMSHIP YORKTOWN.—Constructed by the Delaware River Iron Shipbuilding and Engine Works, Chester, Pa.

each supplied with four steel boilers having a diameter of 13 feet 9 inches, and a length of 12 feet 6 inches, sustaining a working pressure of 180 pounds to the square inch, which supplies ample steam. Each boiler has three corrugated furnaces 44 inches in diameter. The smokestack is unusually high, to obtain good natural draught, and measures 86 feet from the grate to the top and is elliptical, 8 $\frac{1}{2}$ by 6.10 feet.

There are three decks and a hurricane deck. The cabins are finished in mahogany, and 100 first-class and 150 second-class passengers can be accommodated. Among other features is the length of forecabin, 86 feet, and the side ports are on a railway. Two elevators facilitate cargo-handling. There are accommodations for 40 steerage passengers, and quarters for 20 of the crew in the forecabin.

The British Steamship America.

MODELED BY AN AMERICAN.

One of the handsomest and yacht-like steamships ever built was the America, built in 1883 by James & George Thomson, of Glasgow, for the National Line, to ply between Liver-

The Steamship Howard.

The Harlan & Hollingsworth Company, of Wilmington, Del., built, in 1895, a single screw steamer for the Merchants' and Miners' Transportation Company, to run between Baltimore and Boston. She is a duplicate of the Fairfax, built by the same firm in 1891 for this line. Her dimensions are: Length on water line, 270 feet; length over all, 293.5; beam, moulded, 42 feet; depth to third deck, 26 feet; depth to fourth deck, 34 feet. She has accommodations for 144 first-class and a few second-class passengers, and is handsomely fitted and furnished. The fourth deck is a light hurricane deck, but has steel beams. On it are three house erections containing the social hall, rooms for first-class passengers, smoking-room, ladies' toilet-rooms, and rooms for the engineers. On top of the forward house is the pilot house and the captain's room, all of which are finished in hard wood. The main saloon, which is finished in mahogany, is located aft of the engine space on the third deck, with a large stairway leading to the social hall above. On this deck are also located the galley and rooms for the cooks, oilers and second-class passengers, with the crew in the extreme forward end.

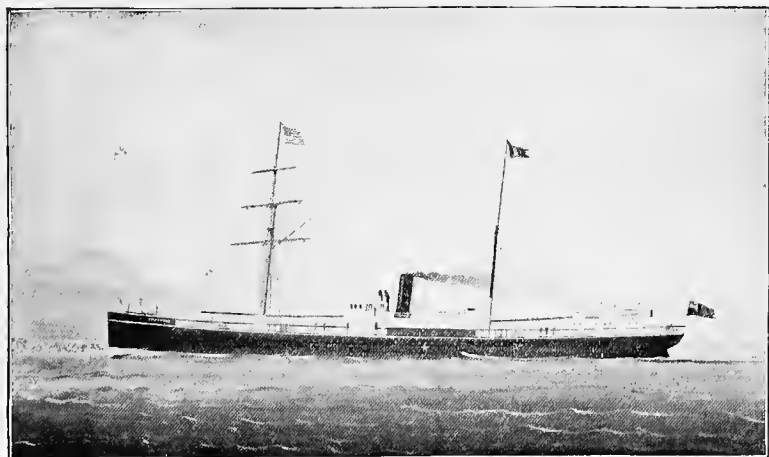

STEAMSHIP BORROWDALE, FORMERLY COMMANDED BY CAPT. WM. TUMBRIDGE, NOW PROPRIETOR OF THE HOTEL ST. GEORGE.

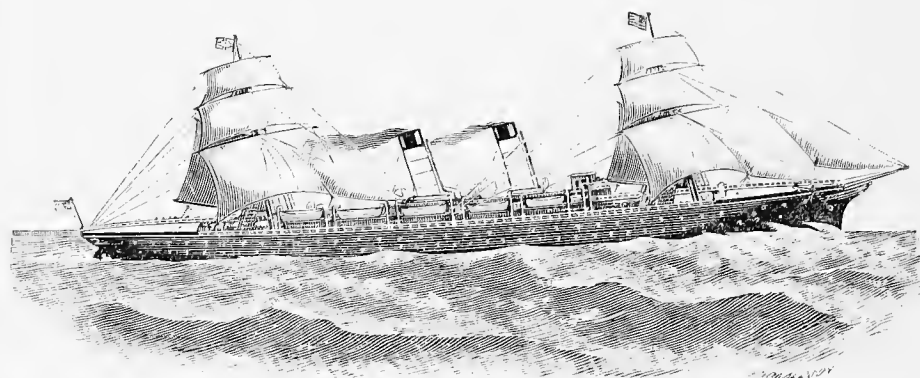

BRITISH STEAMSHIP AMERICA.—Modeled by an American.

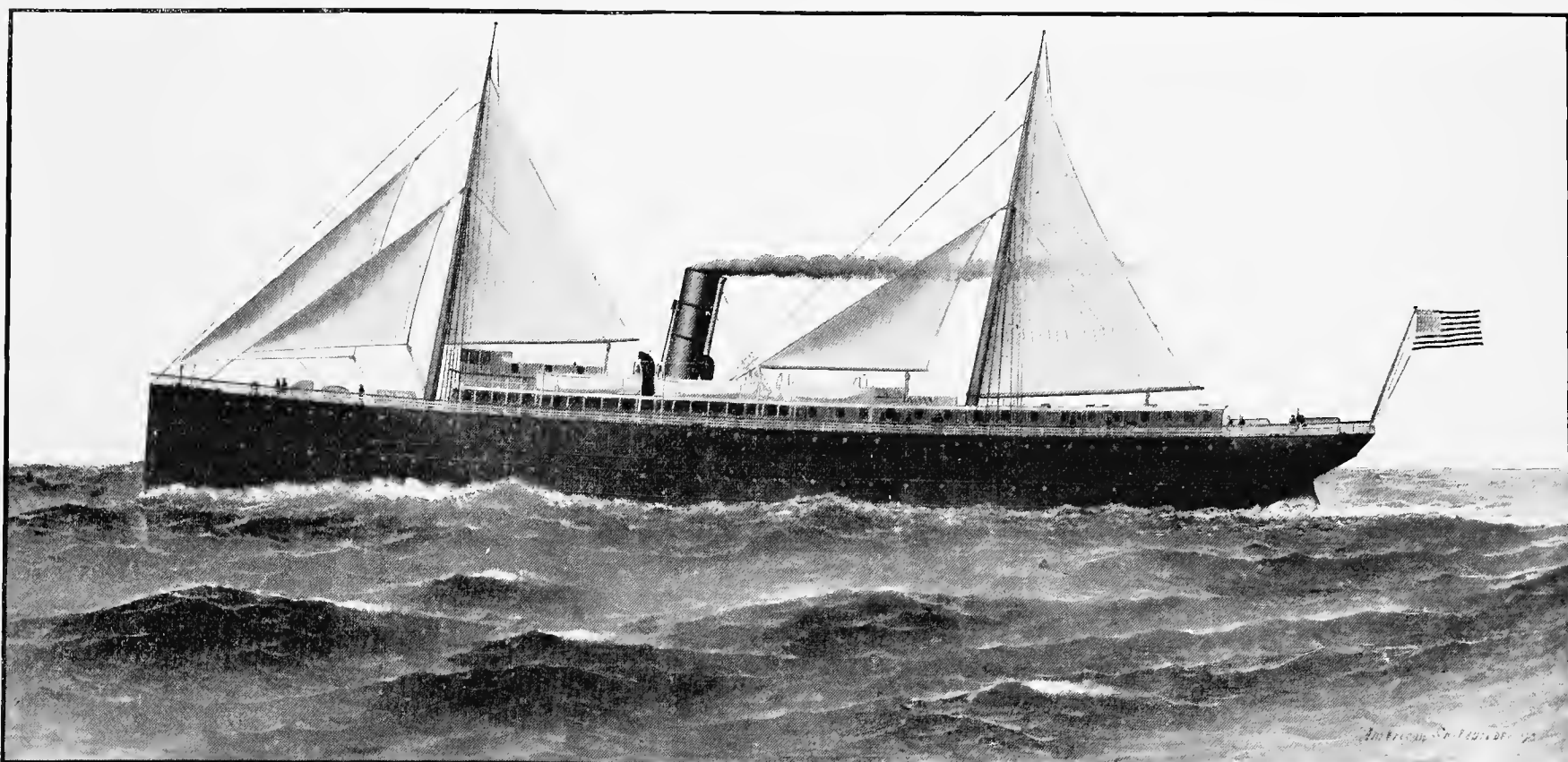

THE MERCHANTS' & MINERS' LINE STEAMSHIP HOWARD.—Built by the Harlan & Hollingsworth Co., Wilmington, Del.

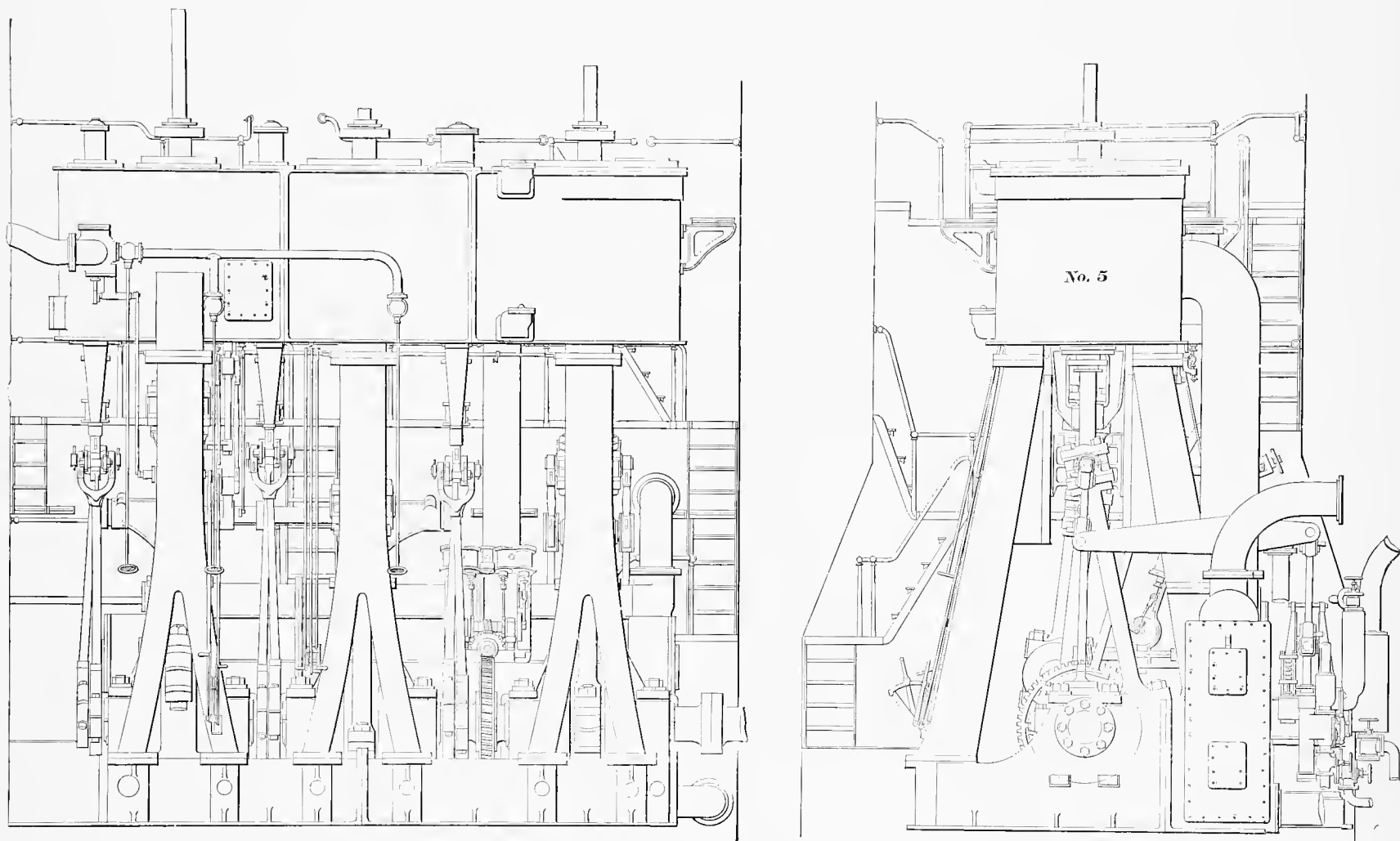

TRIPLE-EXPANSION ENGINE OF NEW STEAMSHIP HOWARD, OF THE MERCHANTS' & MINERS' LINE, BALTIMORE, MD.

The air, feed and bilge-pumps are worked from the low-pressure crossheads; the circulating-pump is of the centrifugal type and is run by an independent engine. The high and intermediate-pressure cylinders are fitted with piston-valves, and the low-pressure with a slide-valve, all worked by Stephenson link motion, and reversed by direct steam gear. The boilers are four in number, each with three corrugated furnaces, and built for working under natural draught at a pressure of 160 pounds per square inch. They are 13 feet 6 inches diameter and 11 feet 6 inches long, and contain 274 square feet of grate and 7,780 of heating surface. There is also an auxiliary boiler 7 feet diameter and 10 feet long, built also for a working pressure of 160 pounds per square inch. The vessel's speed is 15 knots at sea, loaded.

ENGINES OF THE STEAMSHIP HOWARD.

These engines are of the direct triple-expansion type, with inverted cylinders, high-pressure cylinder, 28 inches diameter; intermediate, 45 inches diameter; and low-pressure, 72 inches

diameter; stroke, 48 inches. A piston-valve is used for the high-pressure cylinder, and double-ported slide-valves for the intermediate and low-pressure cylinders; the latter valves are fitted with springs on the back. The piston-rods, tail-rods and crank shaft, which latter is of the built-up type, are made of hammered scrap iron. The valve-rods are made of steel, with balance pistons at the upper ends of the intermediate-pressure and low-pressure valve-rods.

The lower ends of the piston-rods are secured with nuts to wrought-iron crossheads, and the latter have cast-iron shoes, fitted with bars of white metal. The packing boxes and glands are bushed with brass, and fitted with Katzenstein's metallic packing. The piston-rods, and the connecting-rods also, are interchangeable. The crosshead-pin brasses are of phosphor-bronze, and the crank-pin brasses are of hard brass, lined with white metal. The bed plate is made of the box form, cast-iron, with circular recesses for the main bearings, which are made of hard brass. The water service pipes are of brass, and reduced to suit the requirements for circulating water through the main journal brasses. The condenser is of cast-iron, with brass tube

heads arranged for $\frac{3}{4}$ -inch solid-drawn brass condenser tubes; these are arranged horizontally. The tubes are arranged in two sections, water passing through the tubes in the upper section, and returning through the tubes in the lower one. The tail shaft is fitted with a sleeve extending from wheel-hub to a point 6 inches forward of packing box gland. The sleeve is bored and shrunk on shaft, and further secured by counter-sunk screws. The stern tube is made of cast-iron, and securely fitted into a recess bored into the stern frame of the ship. The brass bushing is fitted with strips of lignum-vitæ placed on end. The thrust block is fitted with brass collars in cast-iron block, lined with white metal, fitted for water circulation, and a tight

by nothing afloat. The construction of these high-speed twin-screw steamships has been planned and carried out with a view of making them not only the most modern and luxurious, but also the strongest and safest conveyances on the great lakes.

They cost about \$600,000 each. The general dimensions of these sister ships are: Length of hull over all, 383 feet; length between perpendiculars, 360 feet; breadth, moulded, 44 feet; depth, 26 feet; load draught, 14 feet; water ballast capacity, 682 tons; load displacement, 4,482 tons; tonnage, gross registered, 4,244 tons; tonnage, net registered, 2,340 tons. The two main engines are of the quadruple-expansion type; diameter of high-pressure cylinder, 25 inches; first

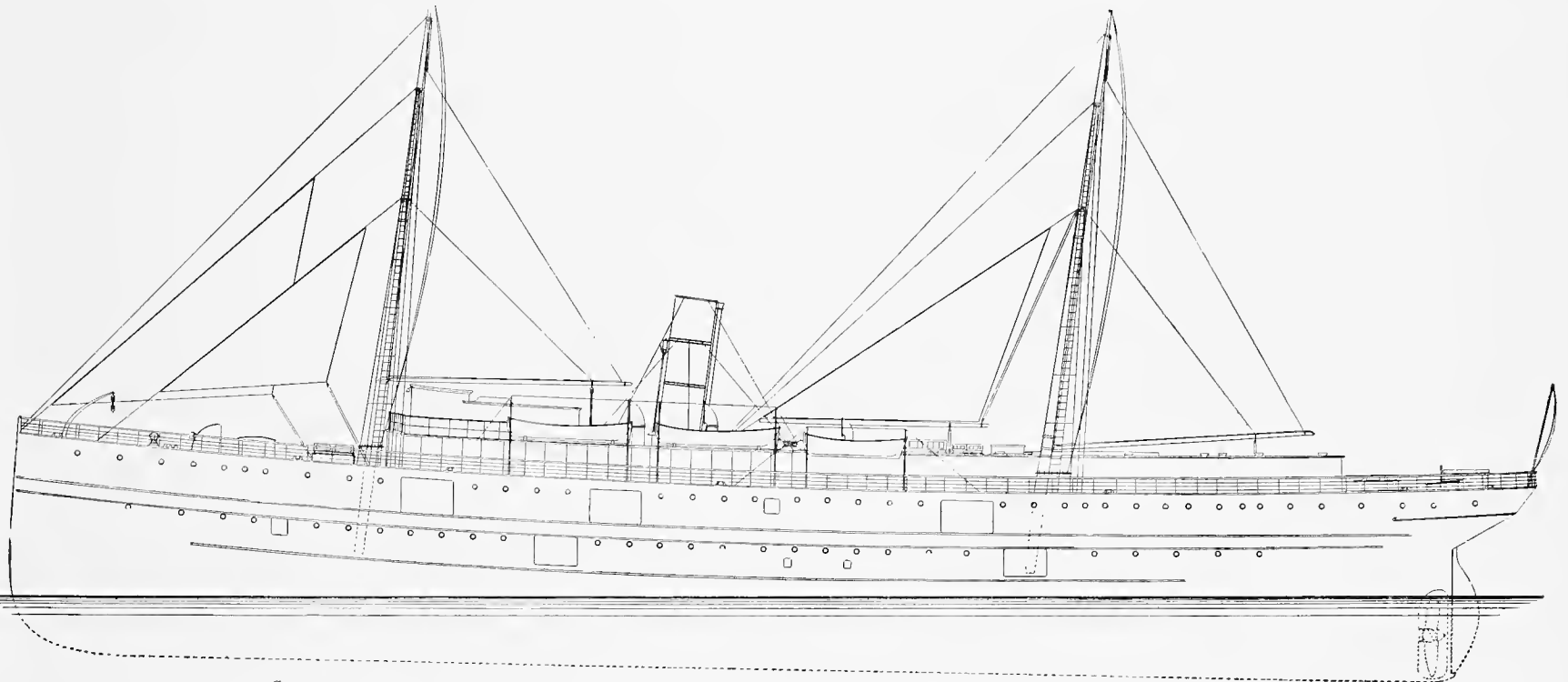

SHEAR PLAN OF THE STEAMSHIP HOWARD, OF THE MERCHANTS' AND MINERS' LINE, BALTIMORE, MD.

box filled with oil for lubrication. The propeller, four-bladed, is 16 feet in diameter, 23 feet pitch, with blades bolted to the hub. The tunnel has a water-tight door aft of the thrust bearing and stuffing box, with gland around shaft through bulkhead. The vessel has six water-tight bulkheads. Four Scotch boilers furnish steam. The Howard and her machinery were built by the Harlan & Hollingsworth Company, Wilmington, Del.

intermediate, 36 inches; second intermediate, $51\frac{1}{2}$ inches; and low-pressure cylinder, 74 inches; stroke, 42 inches. Total indicated horse-power, 7,000. Twin-screws, four blades each, 13 feet diameter and 18 feet pitch. The crank shafts are of wrought-iron of the built-up type; diameter of shafts, $13\frac{1}{2}$ inches; the crank pins are 14 inches diameter and 16 inches long. Solid couplings are forged to the shafts. The bed plate is made in four cast-iron sections, planed and bolted together. The thrust block is of the horseshoe type, with cast-iron shoes faced with babbitt metal, the sole plate is bolted to the bed plate. The cylinders are without jacket or liners, and the valve chests are connected by faced joints and turned bolts. Piston-valves are adopted for all the cylinders, one for the high-pressure cylinder and two for each of the other cylinders. The valves are operated by the Joy valve gear and reversed direct by steam and hydraulic gear. The pistons in the high and first intermediate cylinders are of cast-iron, and those in the second intermediate and low-pressure cylinders are of steel, cone-

Twin-Screw Passenger Steamers North West and North Land.

These fast and elegant steamers were built by the Globe Iron Works, Cleveland, Ohio, for the Northern Steamship Company, to ply between Buffalo, N. Y., and Duluth, Minn. The North West and North Land are, except in size, surpassed

shaped ; all the pistons are fitted with single ring packing, and set out with flat bent springs.

The machinery of the vessel embraces, all told, 65 steam cylinders, 26 pump cylinders, 6 centrifugal pumps, 6 fan blowers, 3 dynamos, one electric elevator, and a steam steerer. Steam is furnished by 28 Belleville water-tube boilers arranged in three groups. Steam pressure is 195 pounds ; engine speed, 120 revolutions.

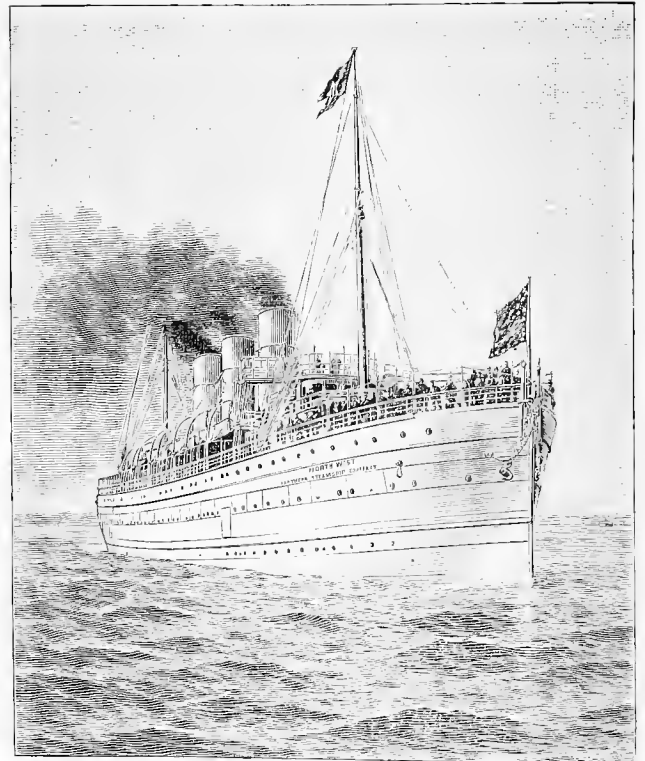

THE TWIN-SCREW STEAMERS NORTH WEST AND NORTH LAND.—Built by the Globe Iron Works, Cleveland, Ohio.

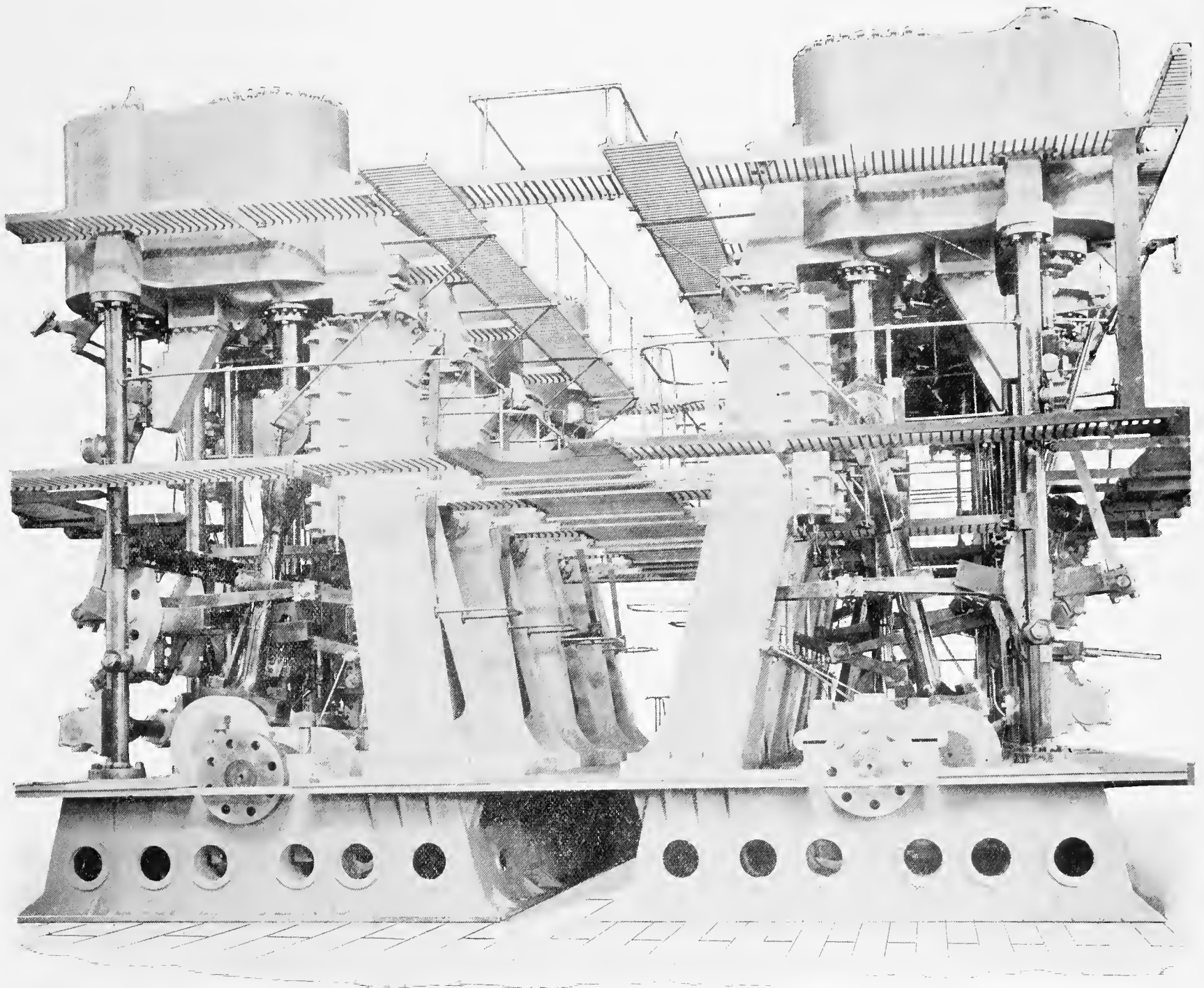

QUADRUPLE-EXPANSION ENGINES OF THE STEAMER NORTH WEST.

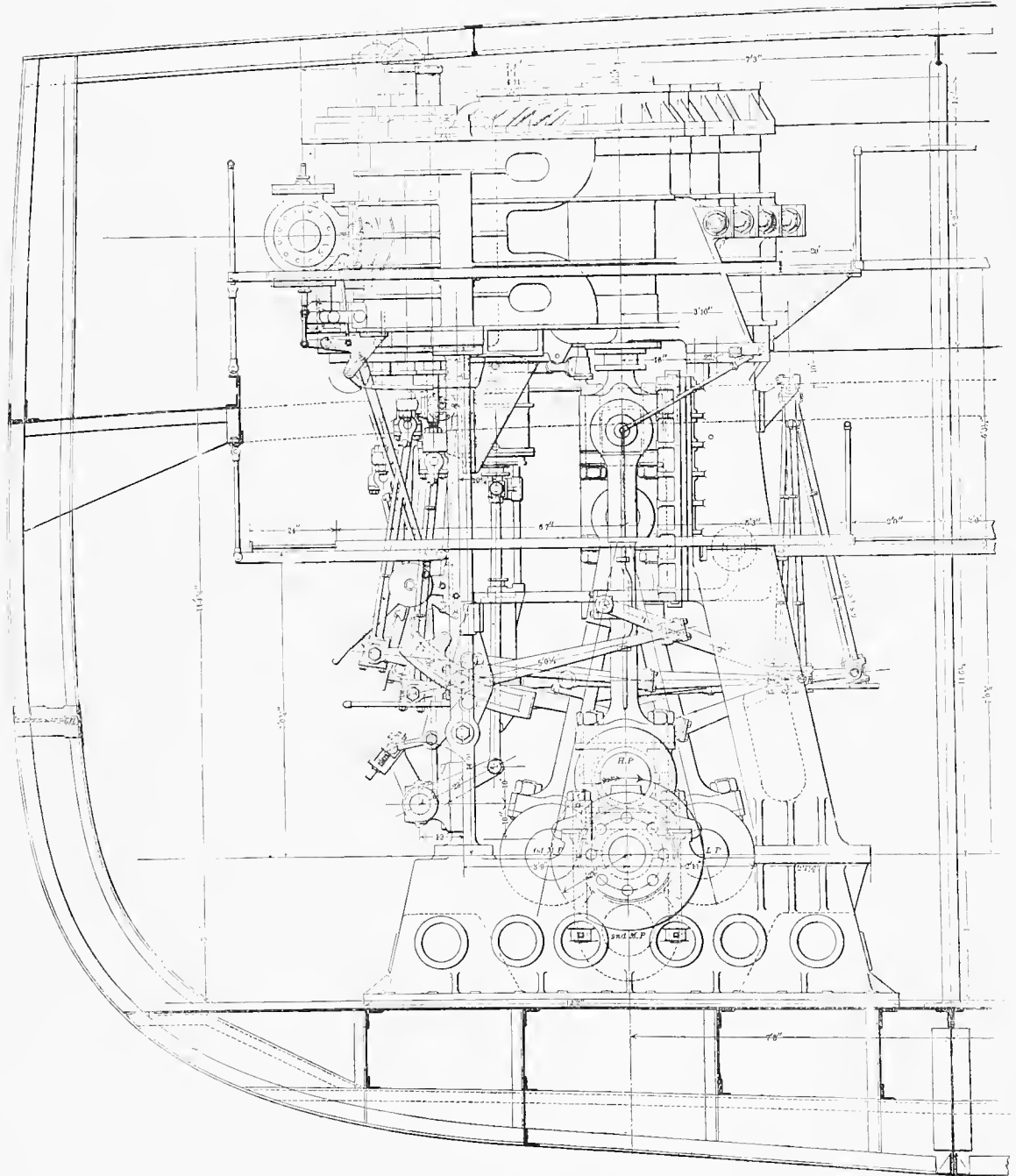

ENGINE OF TWIN-SCREW STEAMER NORTH WEST.



TWIN-SCREW STEAMER NORTH WEST.

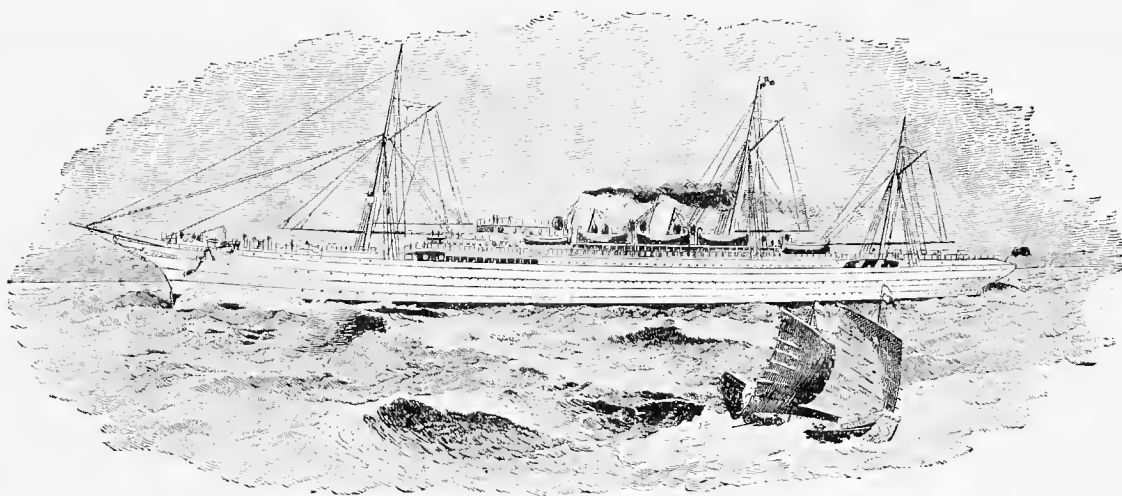

TWIN-SCREW STEAMER EMPRESS OF JAPAN.

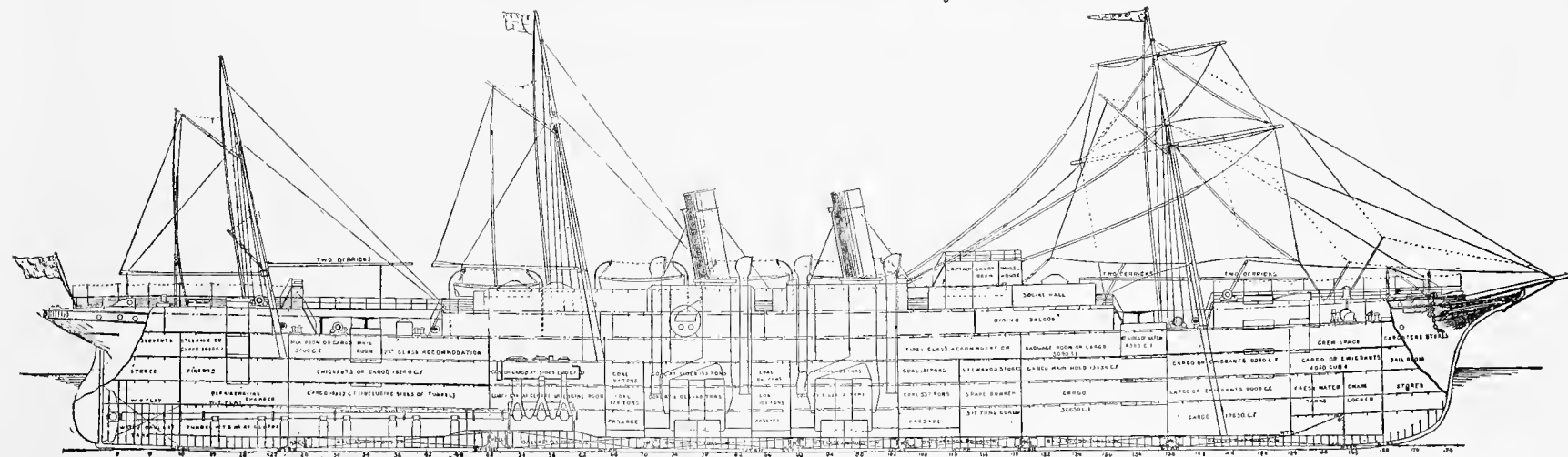

GENERAL PLAN OF STEAMSHIP EMPRESS OF JAPAN.

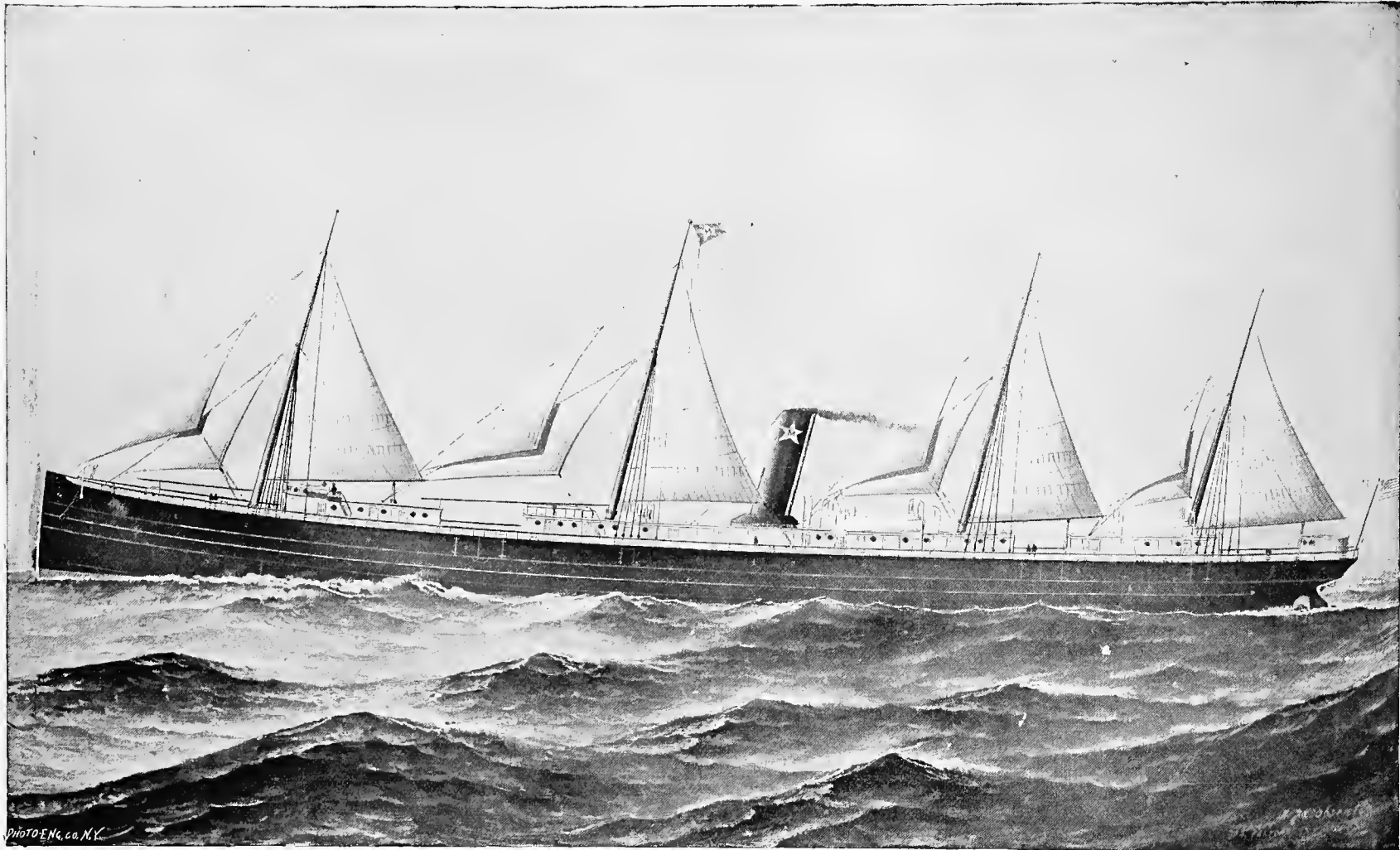

THE MORGAN LINE STEAMSHIP EL SOL.—Built by Wm. Cramp & Sons.

The Steamship El Sol.

This fine freight steamer was built by Wm. Cramp & Sons for the Morgan Line, in 1890, for service between New York and New Orleans in connection with the Southern Pacific Company. She was built according to the rules of the American Shipmasters' Association. General dimensions of the hull: Length over all, 405 feet; length on water line, 390 feet 10 inches; beam, moulded, 48 feet; depth, moulded to hurricane deck, 33 feet 9 inches; gross tonnage, 4,522 tons; net tonnage, 3,021 tons. The El Sol's machinery consists of a triple-expansion surface-condensing direct-acting marine engine with inverted cylinders working on cranks at angles of 120° . The cylinders are 32, 52 and 84 inches diameter respectively, and the length of stroke is 54 inches. The valves are of the piston-slide variety, placed on front of engine close to cylinders and actuated by improved Marshall's valve gear. The surface condenser has 6,400 square feet of cooling surface, water being furnished by an independent centrifugal circulating-pump. The crank shaft is 16 inches in diameter. The screw propeller is four-bladed, built up and 18 feet in diameter. Steam of 160

pounds pressure is supplied by three double-ended cylindrical steel boilers 13 feet 10 inches diameter by 20 feet 6 inches long, having 18 44-inch circular corrugated furnaces, 6 in each boiler, leading into one common combustion chamber, fired fore-and-aft from two fire-rooms.

Twin-Screw Steamer Empress of Japan.

The cuts show a perspective view and general plan of the steel steamship Empress of Japan, sister ship to the Empress of India and Empress of China, built in 1891 by the Naval Construction and Armament Company at Barrow-in-Furness, England, for the Canadian Pacific Railroad Company, and intended for the line between Vancouver and Hong Kong. The principal dimensions of the vessel are: Length, 485 feet over all; breadth, 51 feet; mean draught, 24 feet 6 inches. She is propelled by triple-expansion engines, 32, 51 and 82 by 54 inches, which on the trial trip developed a total of 9,120 horsepower, giving the ship a speed of 18.5 knots an hour.

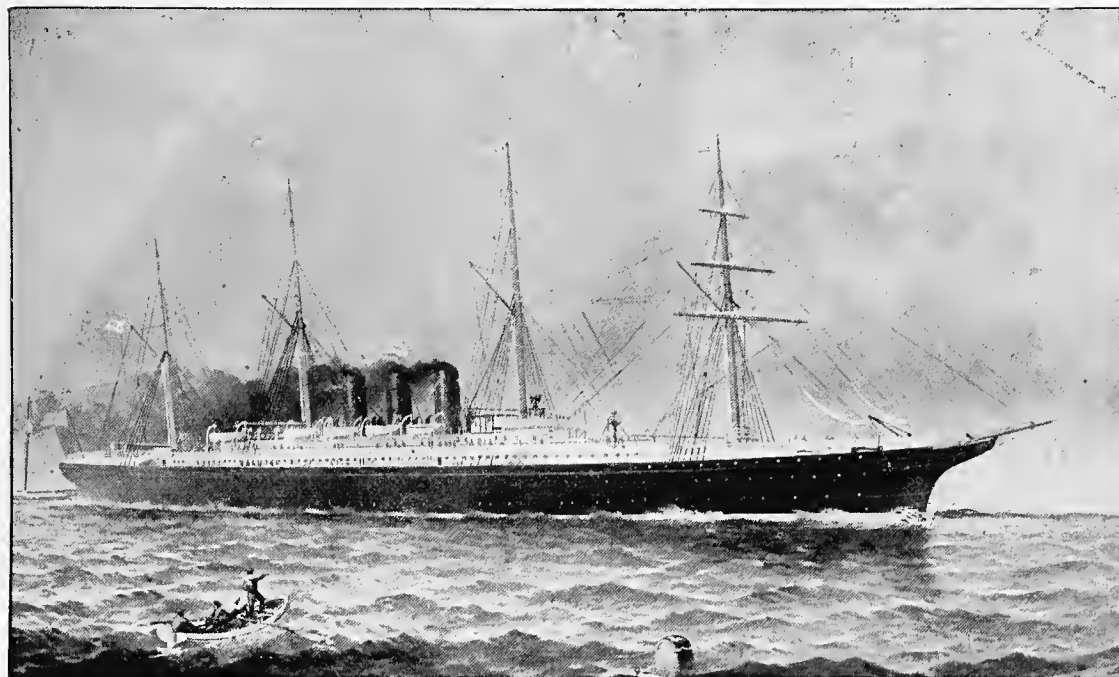

THE ANCHOR LINE STEAMSHIP CITY OF ROME.

The Anchor Line Steamship City of Rome.

This magnificent steamer was built at Barrow-in-Furness, by the Barrow Shipbuilding Company for the Inman Line. Owing to the ship not having come up to speed requirements, she was thrown back on the builders' hands, and they, unable to sell her, made arrangements with the Hendersons, of Glasgow, to take her off their hands. Her gross register tonnage is 8,415 tons; length being 560 feet, breadth of beam 52.3, and depth of hold 37 feet. Notwithstanding her immense size, she is on all hands acknowledged to be unsurpassed for beauty and symmetry even by the finest yachts. The vessel has three funnels. Her displacement on 26 feet draught is 13,500 tons. Her screw is 24 feet in diameter. She has three cylinder compound engines of 10,000 horse-power, one 63-inch and two 91-inch cylinders, with a stroke of 66 inches.

The Freight Steamship El Rio.

The El Rio is from the yards of the Newport News (Virginia) Shipbuilding Company. She runs between New York and New Orleans, carrying freight only, and is owned by the Morgan line. She is a steel steamer of 4,500 tons register, and of the following general dimensions: Length between stem and after-side of propeller post, 380 feet; breadth of beam, moulded, 48 feet; depth from top of keel to top of upper deck beams of lowest part of sheer, 33.9 feet; length over all, 406 feet. She has three decks and a partial orlop deck at fore end of forehold. On the awning deck are iron houses. Freight hatches and ports are located so as to handle cargo expeditiously. There are three double-ended Scotch boilers, measur-

ing 20 feet 6 inches in length by 13 feet 10 inches in diameter. The boilers work ordinarily under a steam pressure of 165 pounds. Each boiler is provided with six furnaces. The engine pistons have no tail-rods, but instead are fitted with adjustable followers. The valves are of the piston-slide variety, placed on the front of the engine close to the cylinders, and actuated by the See-Marshall valve gear. The surface condenser has 6,400 square feet of cooling surface, water being furnished by an independent centrifugal circulating-pump. The crank shaft is 16 inches in diameter. The propeller is four-bladed, of the built-up type, and measures 18 feet in diameter. The bunker capacity of the El Rio is 1,000 tons. As the coal consumption does not exceed 60 tons per day, the ship can coal in New York for the round trip, and on return have at least 200 tons of coal on hand. She is propelled by a vertical triple-expansion engine with three cranks, placed at angles of 120°. The cylinders are 32, 52 and 84 by 54 inches stroke. The vessel and her machinery were built under the supervision of Horace See. The Newport News Works is capable of constructing the largest merchant steamers or war ships afloat, thanks to the enterprise of C. P. Huntington who put his money in this great Virginian establishment, and to C. B. Orcutt, the President of the company, for his executive ability in carrying out the plans of his distinguished chief, who is ranked among the shrewdest financiers of this country.

ENGINE OF STEAMSHIP EL RIO.

This engine is of the triple-expansion type, cylinders 32, 52 and 84 inches diameter, 54 inches stroke. The distribution of steam in the high-pressure cylinder is controlled by one piston-valve, another valve of the same type performs a similar duty for the intermediate cylinder, and two piston-



STEAMSHIP EL RIO.—Built by the Newport News (Virginia) Shipbuilding and Dry Dock Company for the Morgan Line in 1893.

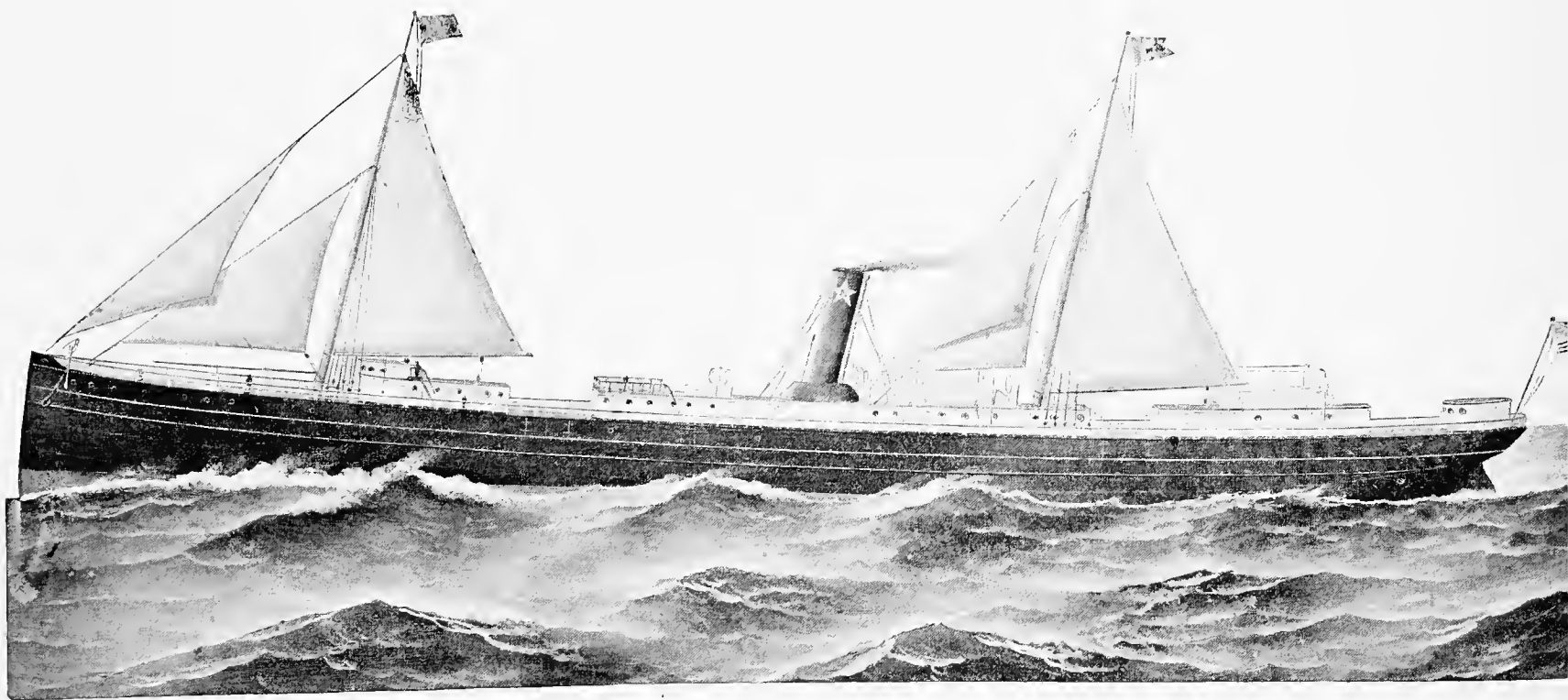

STEAMSHIP EL RIO.—Constructed by the Newport News (Virginia) Shipbuilding and Dry Dock Company for the Morgan Line.

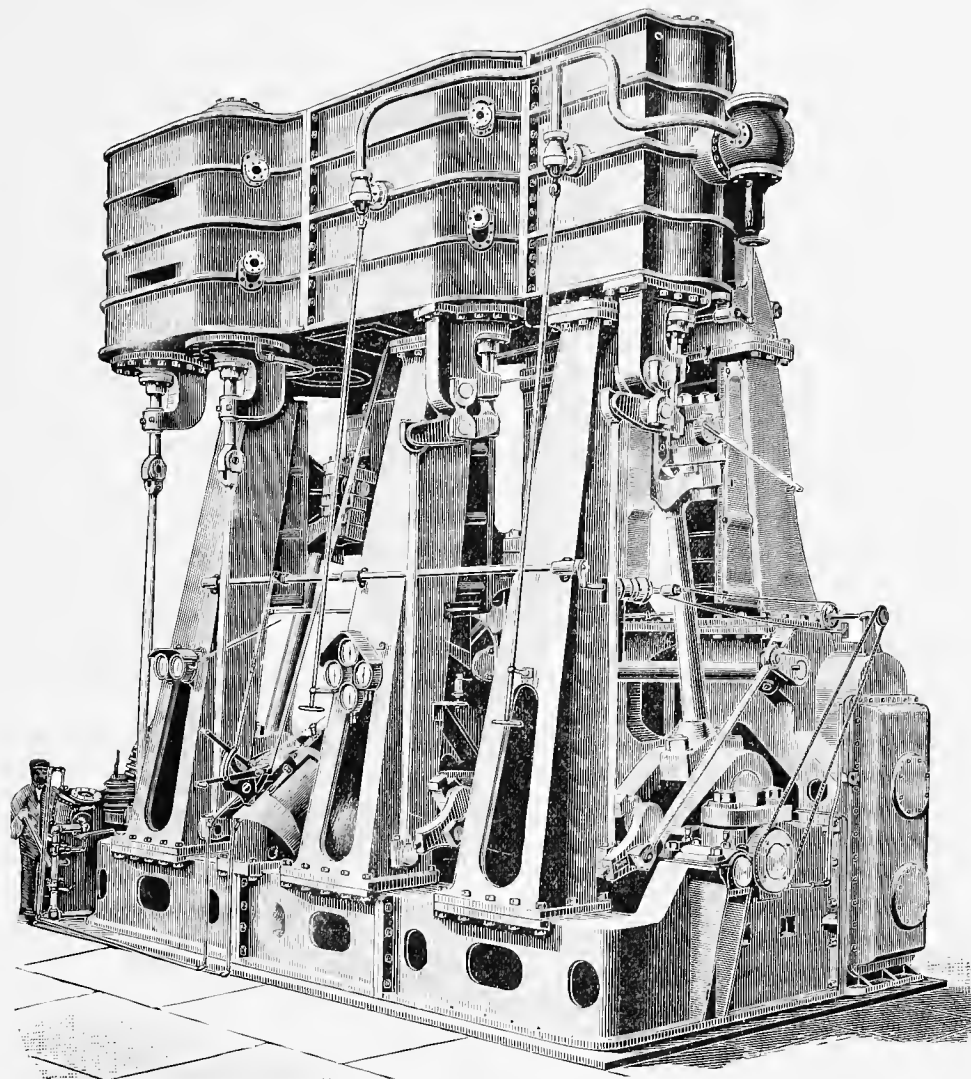

TRIPLE-EXPANSION ENGINE OF THE MORGAN LINE STEAMSHIP EL RIO.

valves are used for the low-pressure cylinder. The steam is introduced in the middle of each valve, which prevents the high-pressure steam from coming in contact with the valve-stem stuffing boxes. All are worked by See-Marshall valve gear, and each valve receives its motion from a separate eccentric; the valves are placed as close as possible to their respective cylinders. In the high-pressure and intermediate valve gear, levers are introduced and connected to the valve stem and valve gear in such a manner as to cause the weight of the valve to counterbalance the weight of the connections below the lever, thereby dispensing with counterbalancing cylinders. The engines are reversed by steam. The main pistons are provided with See's patent adjustable followers. Each follower is cut in three parts, so as to permit of adjustment to compensate for wear and of centering without the employment of tail-rods, and will at the same time insure a steam-tight piston without undue friction. These followers are applicable to horizontal, vertical or inclined engines. The general construction is so plainly shown that a further description is unnecessary. Pistons with these adjustable followers are now in use on the steamers Connecticut, El Sol, El Sud, El Norte, El Toro, Dorothy, Morgan City, Algiers and New York, and we are informed that they

give excellent satisfaction. The piston-rods of the El Rio are $7\frac{1}{2}$ inches diameter; these and the valve stems are fitted with metallic packing. The crank shaft is $16\frac{1}{2}$ inches diameter; crank pin $16\frac{1}{2}$ inches diameter by $16\frac{1}{2}$ inches long; crosshead pins, 8 inches diameter, $9\frac{1}{2}$ inches long. The shaft is fitted with Smith's adjustable thrust bearing, consisting of go-ahead and backing bearings. The air-pump, single acting, is 32 inches diameter; stroke, 25 inches. Total cooling surface in condenser is 6,400 square feet. An independent centrifugal circulating-pump is connected to the condenser, sea bilge and ballast tank. Steam is furnished by three double-ended boilers 13 feet 10 inches diameter and $20\frac{1}{2}$ feet long; each contains six corrugated furnaces 43 inches inside diameter. Total grate surface, 400 square feet; total heating surface, 10,650 square feet; working steam pressure, 165 pounds. The propeller is a built-up one with four blades; it is 18 feet diameter, pitch 22 feet, true screw. On her trial trip the El Sud, which is a sister ship of the El Rio, and whose engine is a duplicate of the one here shown, developed 3,362 indicated horse-power, with a steam pressure of 165 pounds, and running at a speed of 73 revolutions per minute.

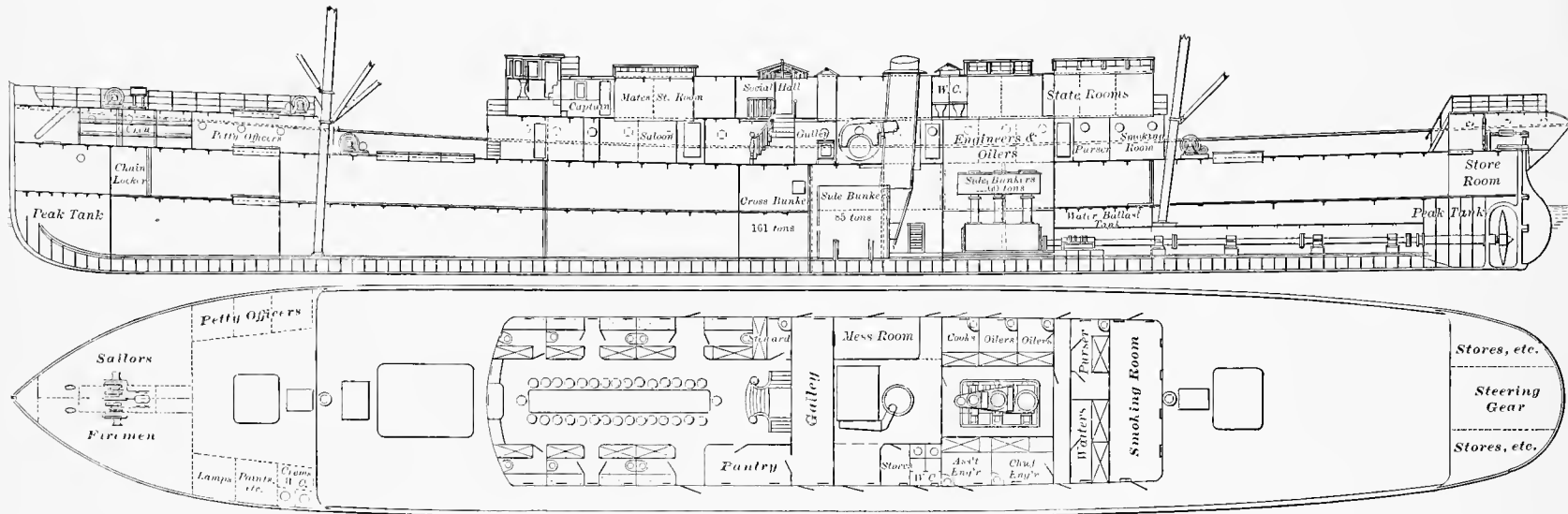

THE RED D LINE STEAMSHIP CURACOA.—Built by Wm. Cramp & Sons, Philadelphia, Pa.

The Red D Line Steamship Curacoa.

With this are given two sections and a plan of a steamship built in 1895 by Wm. Cramp & Sons. This vessel belongs to the Red D Line, of which Boulton, Bliss & Dallett are managing owners, and who use her for their trade between New York and Maracaibo. In order to cross the bar at the latter port, the draught is limited to 10 feet only, which enables the vessel to carry 900 tons dead-weight. The gross tonnage is 1,500 tons; the speed is 11 knots, and 12 knots were made on a trial of four hours' duration, which places her in the fourth class of the U. S. ocean mail service. The engine is of the triple-expansion type, with cylinders 18, 28 and 45 inches diameter, 30 inches stroke. The boilers are of steel, built for a working pressure of 160 pounds per square inch. A donkey boiler furnishes steam for all auxiliary purposes. All the pumps are independent. The hull is of steel, with a steel deck for half the length of the vessel amidships; there is also a steel deck house, containing passenger accommodations, a forecabin for the crew, and turtleback aft, all as shown on plans. The vessel has five water-tight bulkheads; also water-ballast compartment aft of engine, and one at each end of steamer; the total capacity of these compartments is about 200 tons. The dimensions of hull are: Length between perpendiculars, 248 feet; beam, moulded, 38 feet; depth, moulded, 17 feet 5 inches. The plans for this vessel were furnished by John Haug, consulting engineer and naval architect, Philadelphia, Pa.

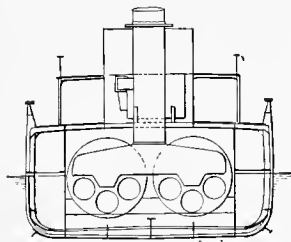

The engine is of the triple-expansion type, with cylinders 18, 28 and 45 inches diameter, 30 inches stroke. The boilers are of steel, built for a working pressure of 160 pounds per square inch. A donkey boiler furnishes steam for all auxiliary purposes. All the pumps are independent. The hull is of steel, with a steel deck for half the length of the vessel amidships; there is also a steel deck house, containing passenger accommodations, a forecabin for the crew, and turtleback aft, all as shown on plans. The vessel has five water-tight bulkheads; also water-ballast compartment aft of engine, and one at each end of steamer; the total capacity of these compartments is about 200 tons. The dimensions of hull are: Length between perpendiculars, 248 feet; beam, moulded, 38 feet; depth, moulded, 17 feet 5 inches. The plans for this vessel were furnished by John Haug, consulting engineer and naval architect, Philadelphia, Pa.

The Whaleback Steamer Joseph L. Colby.

This vessel has attracted widespread attention, as she is the only American whaleback steamer running on the Atlantic seaboard. She has certainly proved herself a splendid sea boat, having been out in all sorts of weather, in the frost, snow, gales and hurricanes of the past three winters. The Colby is 265 by 36 by 24 feet in size, with a cargo capacity of 2,100 gross tons. She was designed by Capt. A. McDougall, of Duluth, Minn.

Whaleback Steamer Charles W. Wetmore.

This pioneer ocean whaleback steamer was built in 1891 by the American Steel Barge Company, West Superior, Wis., from designs of Capt. Alexander McDougall. Her first voyage was to Liverpool, from whence she went to San Francisco; shortly after her arrival on the Pacific coast she was wrecked on a sand bar in the Columbia River, Oregon. The extraordinary carrying capacity of the vessel may be judged from the fact that with dimensions of 265 feet long by 38 feet beam and 24 feet depth of hold, she carried 95,000 bushels of wheat, and actually 87,000 bushels on a mean draught of 15 feet 10 inches. Her weight capacity was 2,900 tons. She had compound engines, 26 and 50 by 42 inches, built by Samuel F. Hodge & Co., Detroit, Mich. Boilers, two in number, of the Scotch type, 11.6 by 11.6 feet, by the Lake Erie Boiler Works, Buffalo, N. Y.

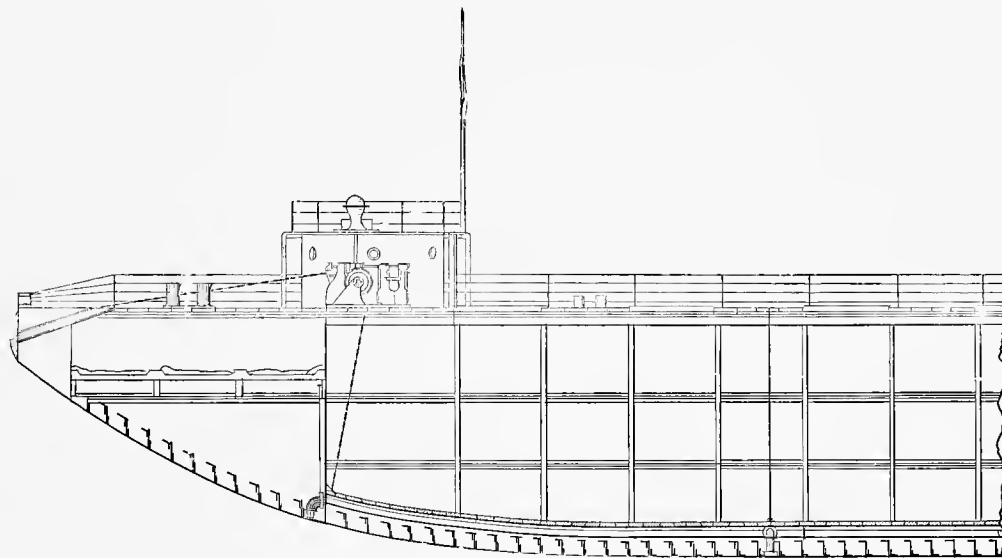
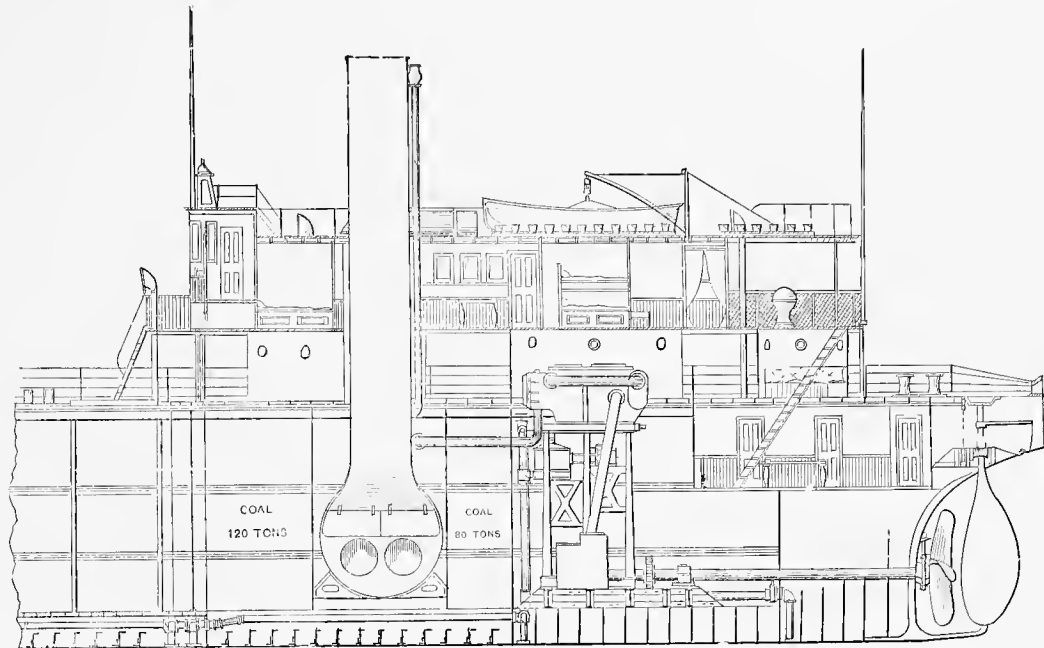

WHALEBACK STEAMER JOSEPH L. COLBY.



MASTLESS OCEAN WHALEBACK STEAMER CHAS. W. WETMORE.

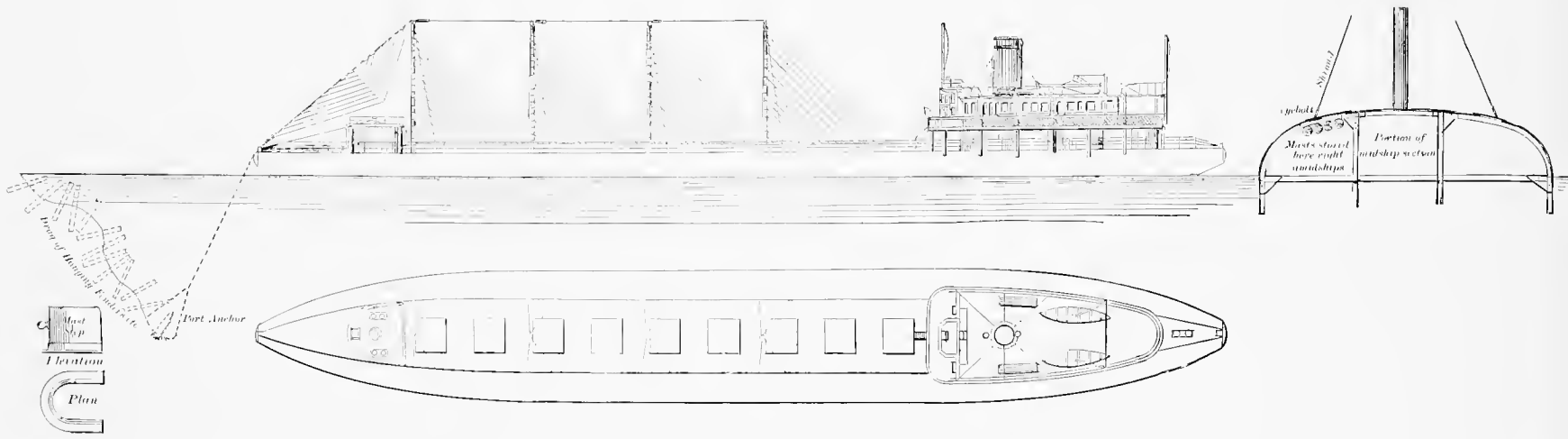

WHALEBACK STEAMER CHAS. W. WETMORE, SHOWING JURY MASTS STEPPED.

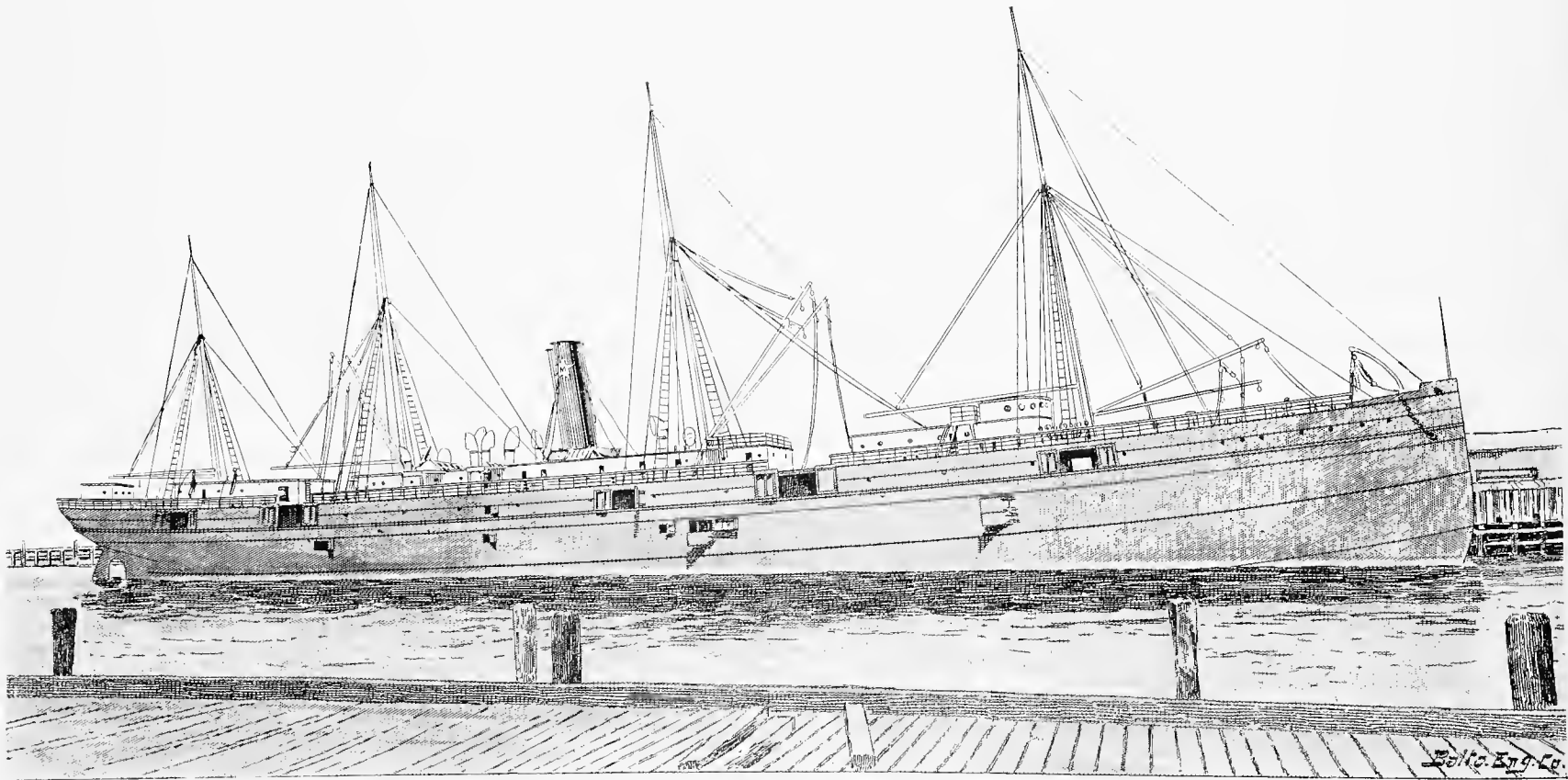

THE MORGAN LINE FREIGHT STEAMSHIP EL NORTE.—Constructed by the Newport News (Virginia) Shipbuilding and Dry Dock Co.

The Morgan Line Freight Steamship El Norte.

This ship was constructed in 1892 by the Newport News (Virginia) Shipbuilding and Dry Dock Company for the Morgan Line, to ply between New York and New Orleans. She is 380 feet long between stem and propeller post and 406 feet over all; breadth of beam, 48 feet; depth, 33.9 feet; registered tonnage, 4,500. There are three decks and a partial orlop deck at the fore end of the forehold. The deck houses are of iron. The engine is of vertical triple-expansion type, with three cranks placed at angles of 120 degrees. The cylinders are 32, 52 and 84 inches by 54 inches stroke of piston, working under 167 pounds of steam, which is generated in three double-ended cylindrical boilers, with three Continental corrugated furnaces at each end.

POUNDS OF WATER EVAPORATED PER POUND OF COAL.

	Sept. 28, 1894. Plain Tubes.	Oct. 5, 1894. Plain Tubes.	Sept. 29, 1894. Serve Tubes.
Per pound of coal	6,600	6,693	8,225
Combustible	7,455	7,674	9,290
Coal from and at 212°	7,228	7,274	8,939
Combustible	8,165	8,332	10,097

Fig. 1 shows the boiler with common tubes; Fig. 2, the boiler fitted with Serve tubes, the section A B and C D being as indicated on Fig. 3. The fan engine and fan are indicated in Figs. 3 and 4, B being the entrance for the air to be heated and C being the damper for shutting off the draft from one boiler when not in use. The course of the air through the boiler is plainly indicated by the arrows.

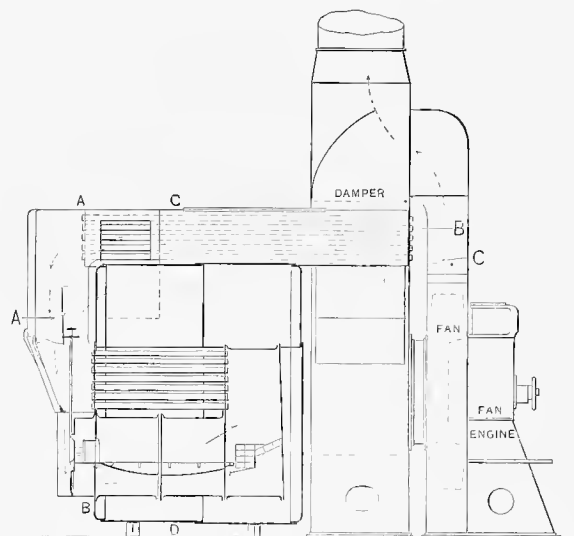
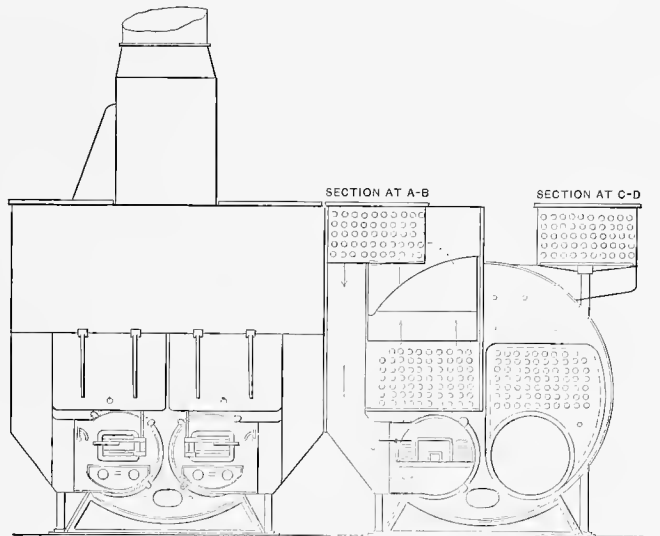

FIG. 1.—BOILER WITH COMMON TUBES.

FIG. 2.—BOILER WITH SERVE TUBES.

FIG. 3.—VERTICAL LONGITUDINAL SECTION.

The Ellis & Eaves Induced or Suction Draft.

Induced or suction draft may be defined as natural draft intensified; that is, there are no difficulties arising from its use that would not be met with in the use of natural draft with a high funnel. In a forced draft system the pressure of the air is behind the gases, which are driven against the plate on the opposite side of the combustion chamber and left to find their way into the tubes as best they can. An undue heating of the tube sheet between the tubes takes place, and leakage at the tube ends results. With the induced draft system the gases are led into the tubes in streams as they come from the furnace, and there is little or no difference between the temperature of the tube sheet and the tube ends, and trouble from leakage is avoided. In the power plant of the American Line, at the foot of Fulton Street, North River, New York, are two boilers of the Scotch marine type, precisely alike in all respects except that one is fitted with 3 1/4-inch outside diameter plain tubes with retarders, and the other with 3 1/4-inch Serve ribbed tubes with retarders, both being used in combination with the Ellis & Eaves suction draft system, for which Charles W. Whitney, of 66 Broadway, New York, is the sole agent for the United States and Canada. The following table shows the results of three separate tests:

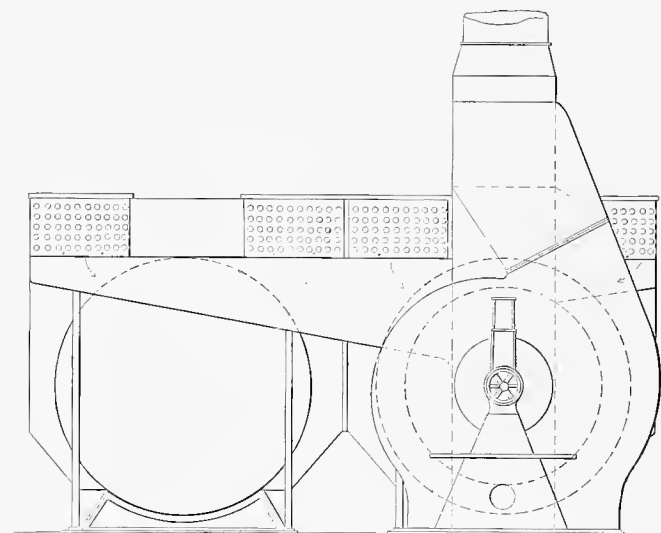
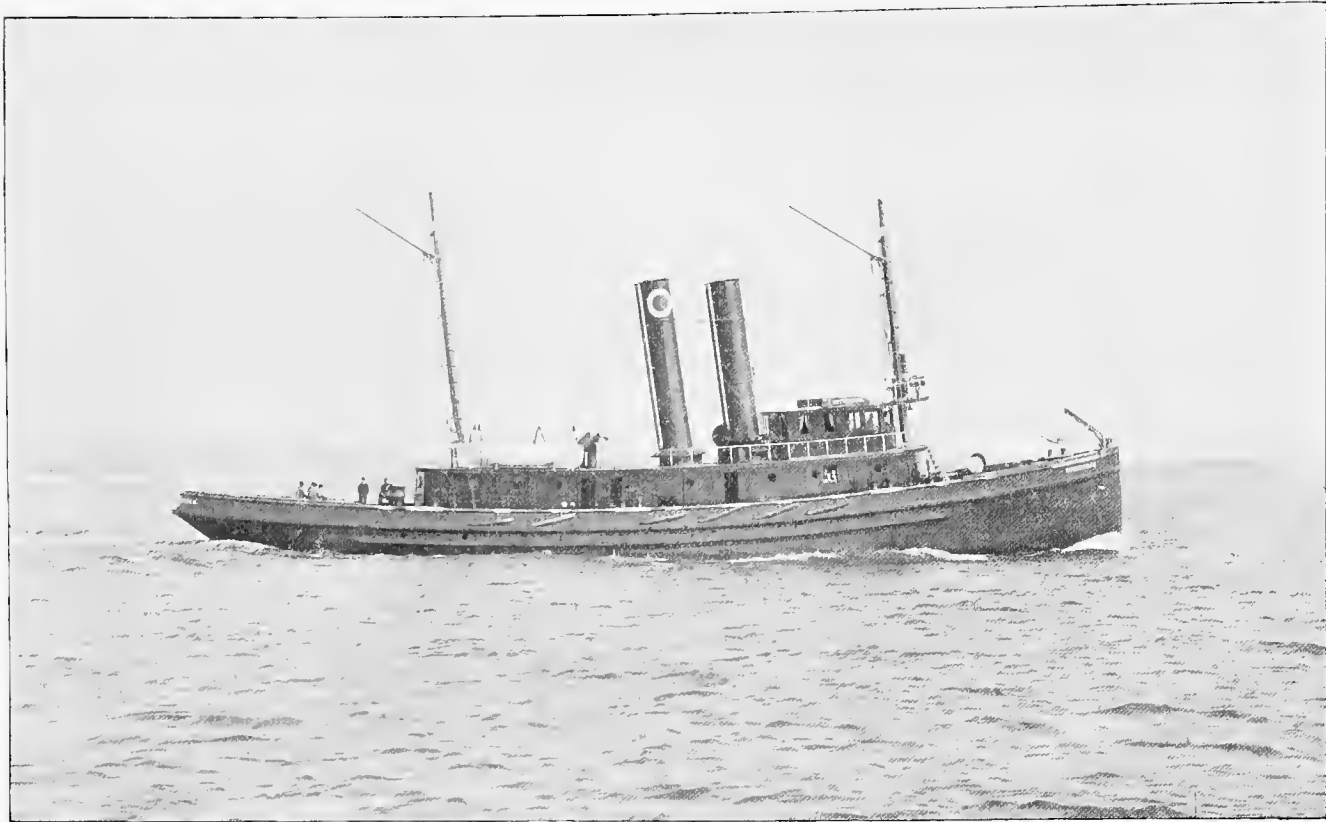

FIG. 4.—REAR ELEVATION, SHOWING POSITION OF FAN ENGINES.



THE SEA-GOING STEEL TUG NOTTINGHAM.—Built by John H. Dialogue & Son, Camden, N. J.

The Sea-Going Tug Nottingham.

The illustration is a reproduction from an excellent photograph of the Nottingham, which is the largest and most completely equipped steel tug ever constructed in the United States for towing only. She was designed throughout by H. C. Wintringham, Havemeyer Building, New York, as he has made a special study of tugboat requirements, and was built under his personal supervision by John H. Dialogue & Son, Camden, N. J., for the Central Railroad of New Jersey. She is used for towing coal barges between New York and points on the New England coast from Boston east. The Nottingham is 140 feet long over all, 27 feet beam and 17 feet depth of hold. She is built of steel throughout, including the deck house, and has three complete water-tight bulkheads dividing the hull into four compartments, and two partial bulkheads, one of which can be made water-tight by closing and fastening one steel door. The steel deck house is lighted and ventilated by large side lights and contains, in addition to the upper engine-room and boiler-room, the galley, pantry and mess-room, and staterooms for the chief engineer, second engineer and mate. There are two boilers of the Scotch type, each 11 feet long and 132 inches diameter, with two corrugated steel furnaces. The bunkers have a capacity for 156 tons of coal.

The engine is of neat design with the condenser in the back frame, and an open front supported on finished steel columns; it is triple-expansion, the cylinders being 16½, 24 and 41 inches in diameters, and 30 inches stroke. The high and intermediate-pressure valves are piston valves and the low-pressure valve a double-ported slide valve. The power is equally divided among the three cylinders, and as there are no pumps driven from the main engine, its motion is very even and free from vibration. It has a steam reversing gear, and is handled from the lower engine-room. There is a sanitary and bilge-pump, which is kept at work continually forcing water to all parts of the vessel. There are also fire and donkey-pumps. All the pumps are separate and independent, and steam can be kept up without running the main engine or wasting water, and the auxiliary engines exhaust into the condenser. Mr. Wintringham, the designer of the boat, has given unusual attention to proportioning and arranging all details of hull and machinery, and has succeeded in producing a tug which is economical and satisfactory in every particular and in advance of the usual practice.

The Nottingham receives her name from a very celebrated brand of Pennsylvania coal, the mines of which are owned by the Central Railroad of New Jersey. On her after smokestack she carries the company's mark—a white disc with red center.

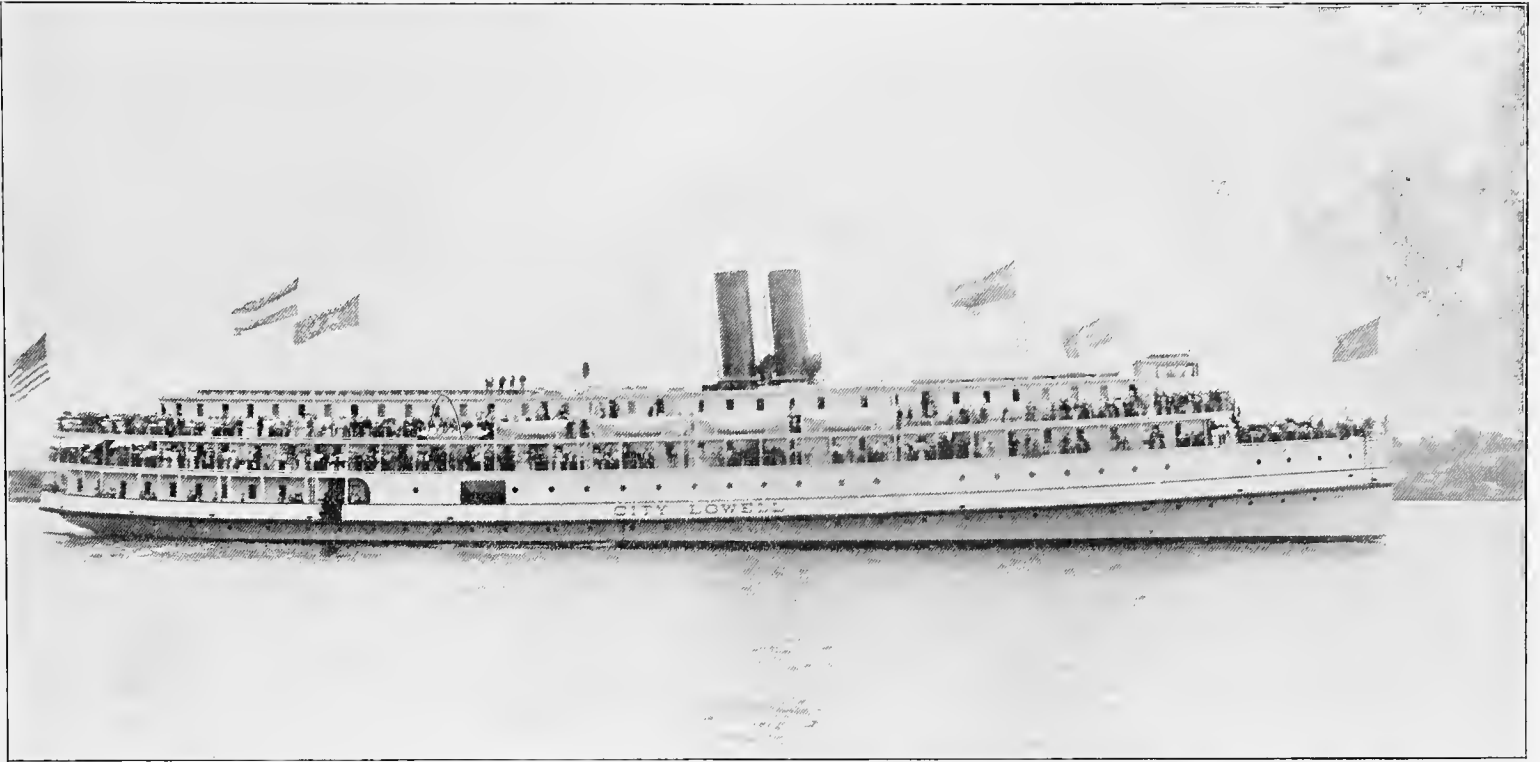

THE NORWICH LINE'S STEEL TWIN-SCREW PASSENGER STEAMER CITY OF LOWELL.—Built by the Bath (Maine) Iron Works.

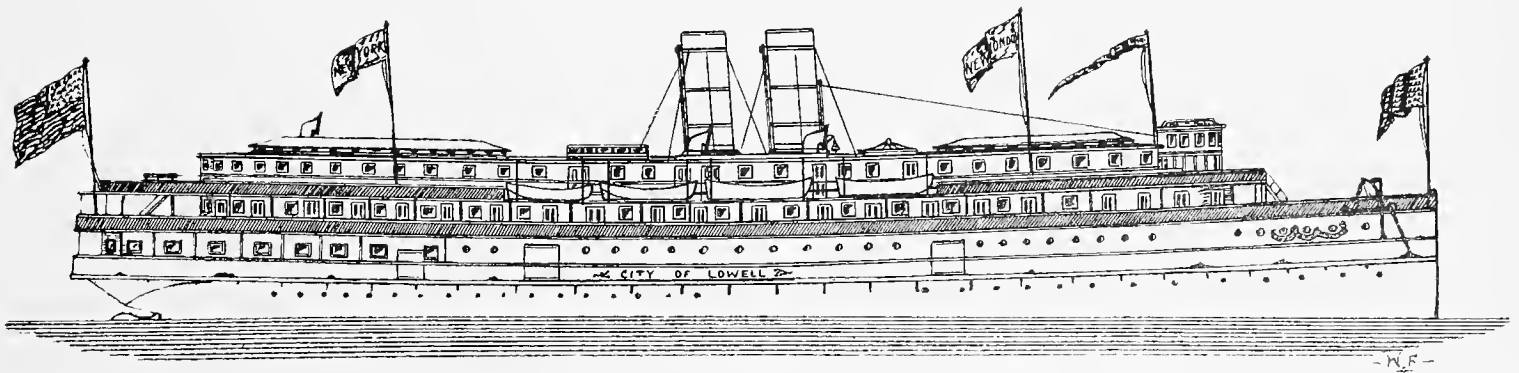

THE NORWICH LINE'S STEEL TWIN-SCREW PASSENGER STEAMER CITY OF LOWELL.
Built by the Bath (Maine) Iron Works from Plans of A. Cary Smith.

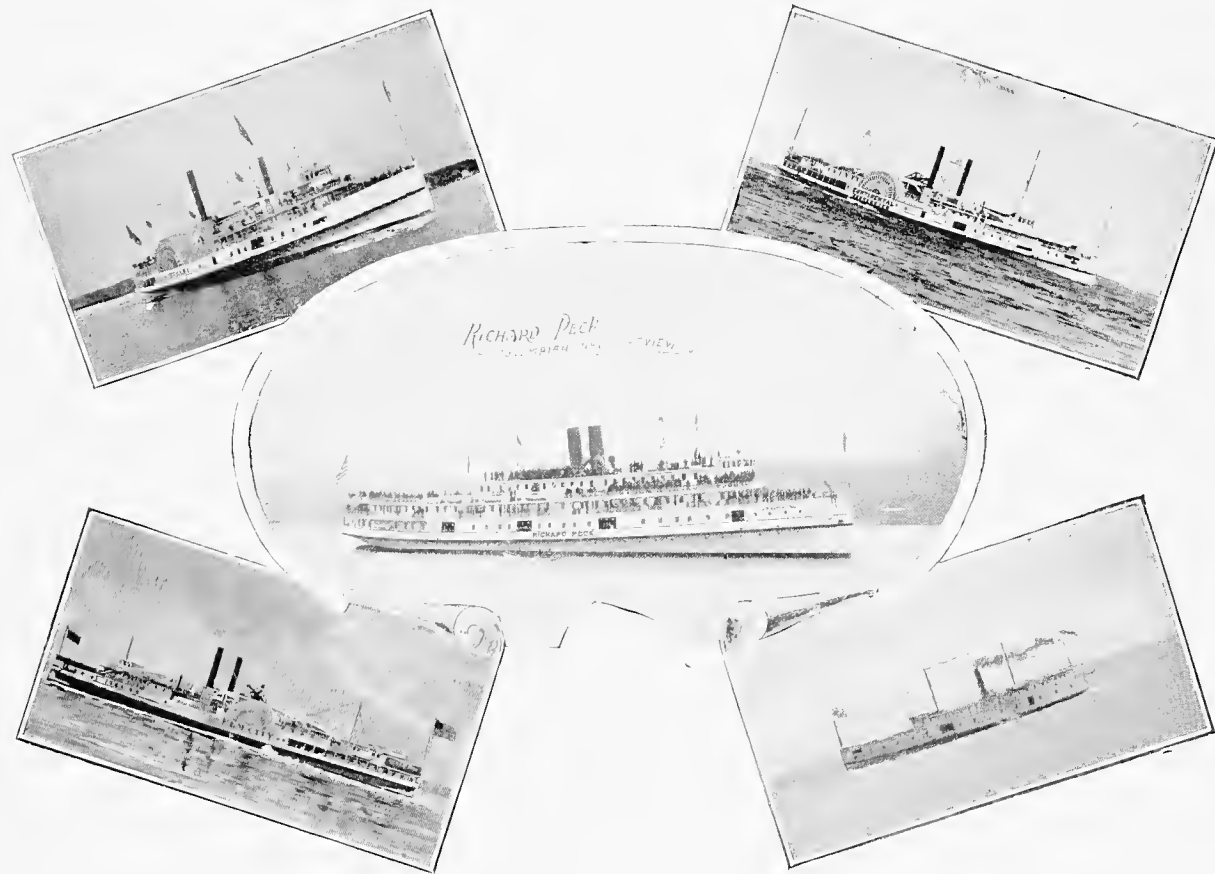

THE NEW HAVEN LINE STEAMBOATS.

The Twin-Screw Steamer City of Lowell.

This steamboat was built in 1894 by the Bath (Maine) Iron Works for the Norwich Line, to run between New York and New London, Conn. She was designed by A. Cary Smith, New York. Her principal hull dimensions are: Length over all, 336 feet $\frac{3}{8}$ inch; length on load water line, 319 feet $10\frac{3}{4}$ inches; extreme breadth over guards, 66 feet 1 inch; moulded beam, 49 feet $6\frac{1}{2}$ inches; load draught, 13 feet; depth of hold, 17 feet 7 inches; tonnage, 2,400 tons. The hull of the vessel is constructed entirely of steel with four complete water-tight bulkheads. She has five decks, named, respectively, lower, main, saloon, gallery and hurricane. The propelling power consists of two independent sets of vertical, inverted, direct-acting, triple-expansion engines, driving twin screws. The cylinders are 26, 40 and 64 by 36, the high-pressure being fitted with a piston valve, and the intermediate and low-pressure cylinders with double-ported slides. The total indicated horse-power, including all auxiliaries, is 4,650 when the main engines are making 125 revolutions per minute, a piston speed of about 750 feet. The cylinders are supported

by heavy wrought-iron columns in front and cast-steel columns behind. The piston-rods are of steel, whilst the connecting and all working rods generally are of wrought iron. The air-pumps are worked from the low-pressure crosshead, and are of 27-inch diameter with 12-inch stroke. The condensers are constructed of composition, and have each a cooling surface of 3,387 square feet. The crank shaft is $11\frac{3}{4}$ inches diameter, and is made of wrought iron with steel crank pins. The propeller wheels are constructed of manganese-bronze, they being four-bladed and 11 feet diameter, with a pitch of about 16 feet. Steam is supplied by six steel single-ended Scotch return tubular boilers, each having a length of 12 feet 10 inches and a diameter of 13 feet 6 inches. They have each three corrugated furnaces of 43 inches internal diameter, and are designed for a working pressure of 165 pounds to the square inch. The boilers are placed three on the starboard and three on the port side of a boiler-room the width of the ship, and are 44 feet long. and two tall smokestacks, 9 by $7\frac{1}{2}$ feet, carry off the refuse gas and smoke. The engines, boilers and coal take up 74 feet of the vessel's length amidships, the total coal bunker capacity being 90 tons, sufficient for the vessel to steam one round trip. The propelling machinery was designed by Chas. E. Hyde.

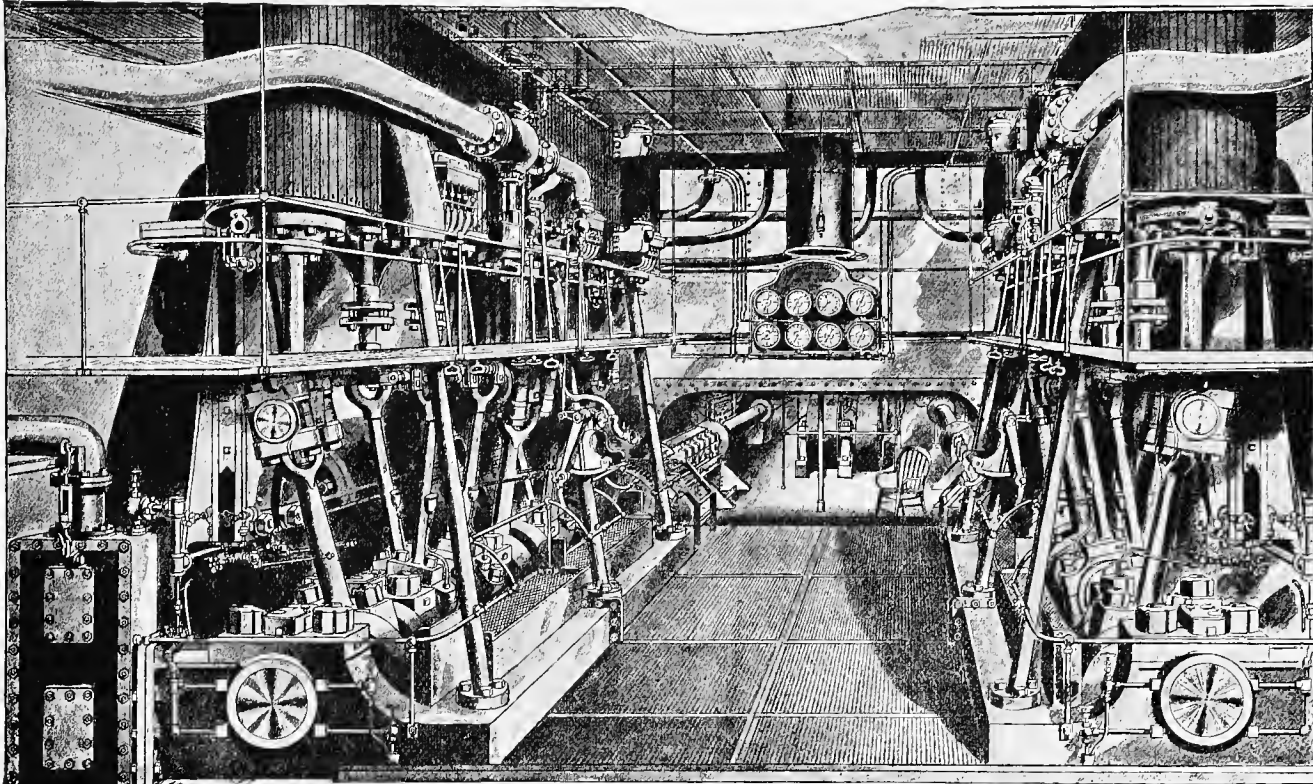

ENGINES OF TWIN-SCREW STEAMER RICHARD PECK.—Built by the Harlan & Hollingsworth Co., Wilmington, Del.

Engines of the Steamer Richard Peck.

It is only recently that the screw has begun to replace the sidewheel in the passenger service on Long Island Sound. How well the twin screw is adapted to the requirements of that service, in the speed attained and ease of manipulation in the crowded waters of the East River, is demonstrated by the success of the Richard Peck, of the New Haven Line, which created quite a sensation at the time of its addition to the fleet a few years ago. Her length on the water line is 300 feet; over all, 316 feet; beam, 48 feet; breadth over guards, 62 feet; depth of hold, $18\frac{1}{2}$ feet. It is in the motive power that our readers will be chiefly interested. This is furnished by two triple-expansion engines having 24, 38 and 60-inch cylinders, and a 30-inch stroke, run regularly at 136 revolutions per minute, or 680 feet of piston speed, and developing, with an initial pressure of 160 pounds, about 4,250 indicated horse-power. A good idea of their general appearance and their arrangement with reference to the boilers, etc., is conveyed by the engraving. The valves are controlled by ordinary marine link motions operated by means of a steam ram, a single stroke of which shifts the blocks through the entire length of the links. The steam rams are operated by the small levers shown in the center of both engines, and so easily are they manipulated that one man standing between the engines can operate both. Piston valves 12 inches in diameter are used on

the high-pressure cylinders, and slide valves on the intermediate and low, those on the low-pressure being double-ported. The valves weigh as follows: high-pressure, 200 pounds; intermediate, 700; low-pressure, about 1,000 pounds. The weight of the slide valve is taken up by pistons working in vertical cylinders over the valves, subjected to the steam chest or receiver pressure below and connected with the condenser above. There are also provided equalizing valves on all the cylinders allowing the steam to escape to the chest or receiver should the pressure in the cylinder exceed, by compression or otherwise, the available initial pressure. Each engine has its own surface condenser of the type ordinarily furnished by the builders of the hull and machinery, the Harlan & Hollingsworth Company, of Wilmington, Del. These are parallel with the engines and behind them. The circulating water is supplied by centrifugal pumps, one for each engine, operated by small vertical engines, directly connected to the pump shafts. Should an accident occur to the circulating apparatus or the surface condenser a jet may be used, and an escape valve is provided for automatically discharging the exhaust to the atmosphere in case of the total disabling of the condenser. The air-pumps are vertical single-acting, operated by beams receiving their motion from the low-pressure crossheads. Two bilge-pumps are also attached to each beam. From the hot-well the water is passed through a hay filter and returned to the boilers by a 10 by 6 by 12-inch Blake feed-pump, the speed of which is

controlled by a Waters' pump governor operated by a float in the filter tank. The exhaust from the boiler feed-pump is turned into the tank, raising the temperature of the feed some 50 degrees. Two Korting Universal injectors are used for forcing water from the fresh-water tanks to the boilers when the engines are not in operation. A by-pass is provided between the steam and water compartments of the surface condensers, by opening which salt water may be added to the condensed steam to make up losses, etc. There are also small Blake

water-jacketed, and have also spray pipes for emergencies. Steam is furnished by six steel Scotch boilers 13 feet in diameter and 12 feet long, with three furnaces each. The furnaces are of corrugated steel, and furnished by the Continental Iron Works, Brooklyn, N. Y., and since boilers of the Scotch type are coming into considerable use in stationary practice, will interest as well the stationary engineer. The corrugations stiffen the tube against the collapsing pressure to which it is subjected, and make possible the construction of furnaces of

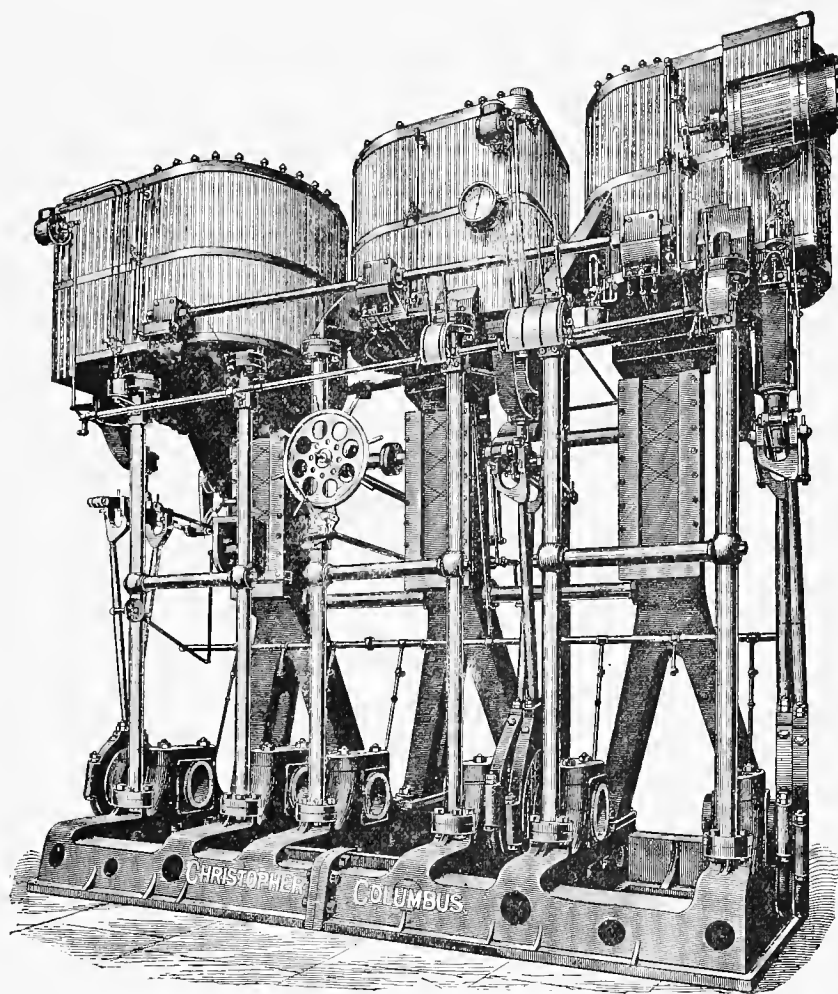

ENGINE OF THE CHRISTOPHER COLUMBUS.—Built by S. F. Hodge & Co.

pumps for circulating both salt and fresh water through the sanitary and water service, and a large fire and bilge pump located on the grating above the engine-room as required by law. The auxiliary pumps, circulating-pumps, engines, electric light engine, etc., are run on 70 pounds pressure, the supply from the main boilers passing through a Foster reducing valve.

The engine main shaft is 11 inches in diameter, and the crank pins have the same diameter and a length of 12 inches. The main bearings are lined with Magnolia metal, and the crank pin boxes with Parsons' white brass. The crosshead pins run directly on the brasses. The slides and main bearings are

uniform thickness sufficiently thin to allow the heat to be transmitted unincumbered with stiffening rings or flanges, and of a strength sufficient to withstand the pressure demanded by modern practice. The furnaces in the Peck are 42 inches in diameter and 8 feet 5 inches long; and there are in each boiler a total of 65 square feet of grate surface. Twelve to fifteen pounds of coal are burned per hour per square foot of grate by natural draft; the stacks, two in number, are 7 feet in diameter and extend about 66 feet above the level of the grates. The three furnaces discharge into a common combustion chamber, from which small return tubes lead the gases to the upstake at

the front of the boilers. There are in each boiler 241 3-inch tubes, each being 8 feet 4 inches long. The boilers are surface blown at night and blown off from the bottom each morning, and each week one is opened and cleaned, so that each boiler receives a cleaning and internal inspection once in six weeks. The oil from the main bearings, guides, etc., is collected in a pit beneath the low-pressure cylinder, passed through a Perfection purifier, and used over and over again. The coal bunker is between the engine and boiler-rooms, and the coal is discharged from the bunker into buckets suspended from overhead tracks, upon which they may be passed to any

Engine of the Whaleback Steamer Christopher Columbus.

This engine was built by Samuel F. Hodge & Co., of Detroit, Mich., for the World's Fair passenger steamer Christopher Columbus, constructed at the yards of the American Steel Barge Company, West Superior, Wis. Engine, 26, 42 and 70 by 40 inches. The high-pressure cylinder is fitted with a piston valve, and the low and intermediate with double ported slide valves, the port openings being ample for a piston speed of 770 feet per minute. None of the cylinders are jacketed, but the high-pressure is fitted with a hard cast-iron

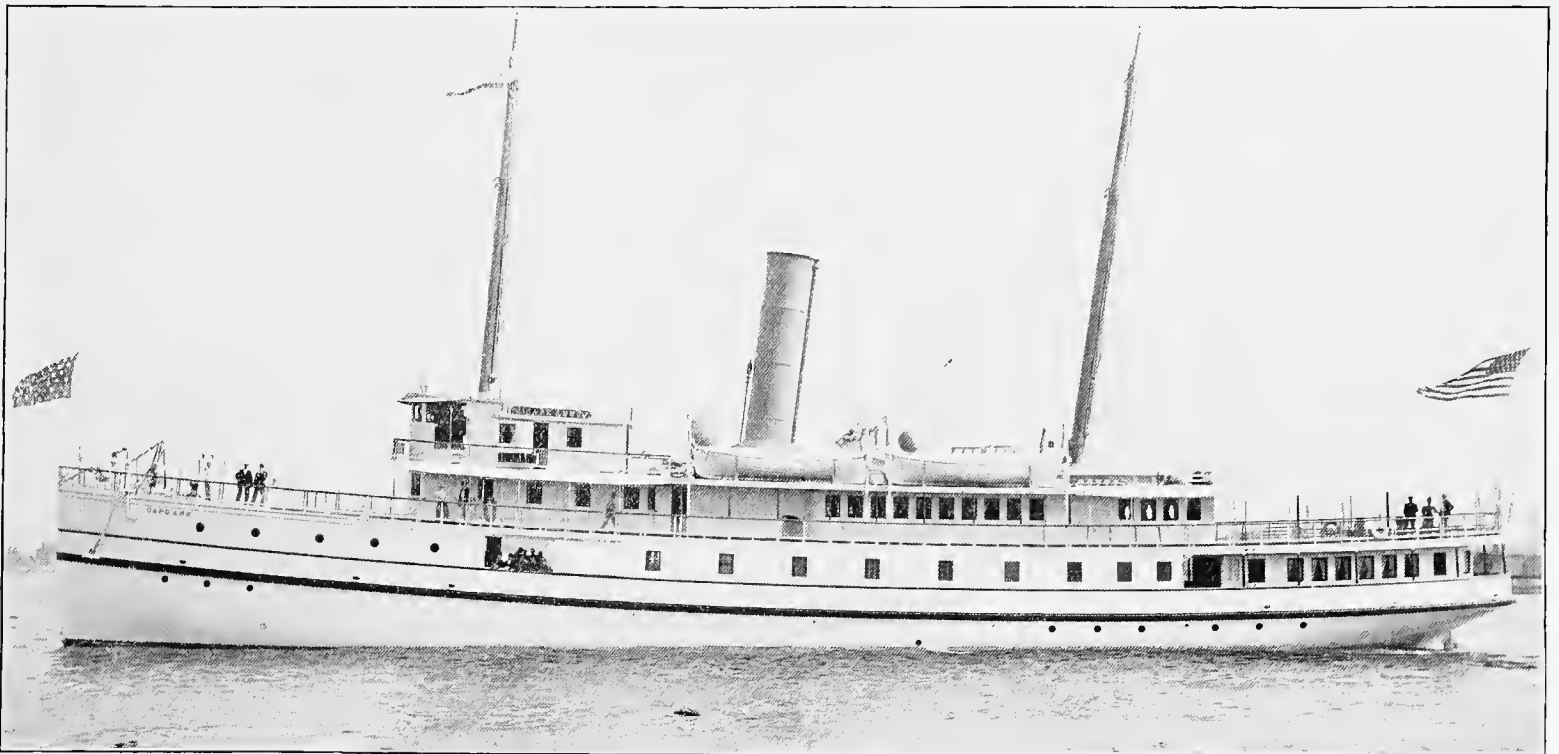

BOSTON AND GLOUCESTER LINE STEAMER CAPE ANN.—Constructed by the Neafie & Levy Ship and Engine Building Co., Philadelphia, Pa.

part of the fire-room. See's ejector is used for discharging the ashes. The boilers are fitted with heaters for promoting circulation in those portions which lie below the level of the grates.

The following additional details will be of interest.: The air-pump is 26 inches in diameter by 13 inches stroke. The crank shaft is of wrought iron, built up, 11 inches in diameter, the crank pins being of the same diameter and 12 inches long. Two of the main journals are 16 inches in diameter, the remaining four being 14 inches. Thickness and breadth of low-pressure crank web, $9\frac{1}{2}$ inches; of intermediate, $8\frac{1}{2}$; high-pressure, $6\frac{1}{2}$. There are five thrust collars on each shaft, $1\frac{3}{4}$ inches wide, spaced $4\frac{3}{8}$ inches apart, with an outside diameter of 18 inches; inside diameter, $10\frac{3}{4}$ inches. Each condenser has 1,036 tubes, $\frac{3}{4}$ of an inch by 16 feet, giving a cooling surface of 3,242 square feet to each condenser.—Power.

liner. The valves are all worked from the ordinary, independently adjustable link motion, all joints having liberal wearing surfaces, and the position of the links is controlled by a combined steam and hydraulic reverse gear, and also a worm and screw hand reverse gear. The crank shaft is of the built-up type, 13 inches in diameter, and made in three interchangeable parts, with steel crank pins $12\frac{1}{2}$ inches diameter, 14 inches long. Each crank is provided with a counterbalance of sufficient weight to balance the pin and its hubs.

The New Steamer Cape Ann.

This elegant screw steamer was built by Neafie & Levy, Philadelphia, Pa., for the Boston and Gloucester Steamboat Company, of Boston, to ply between the latter city and

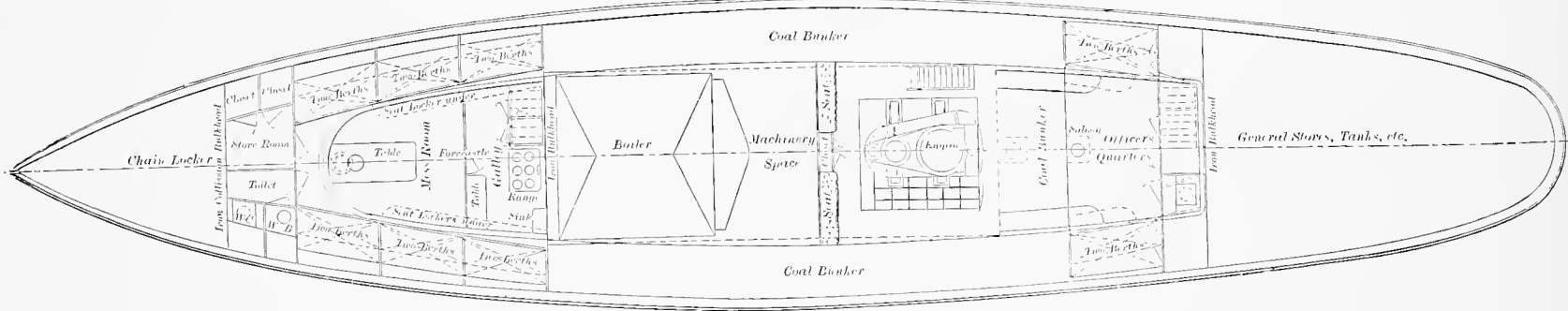
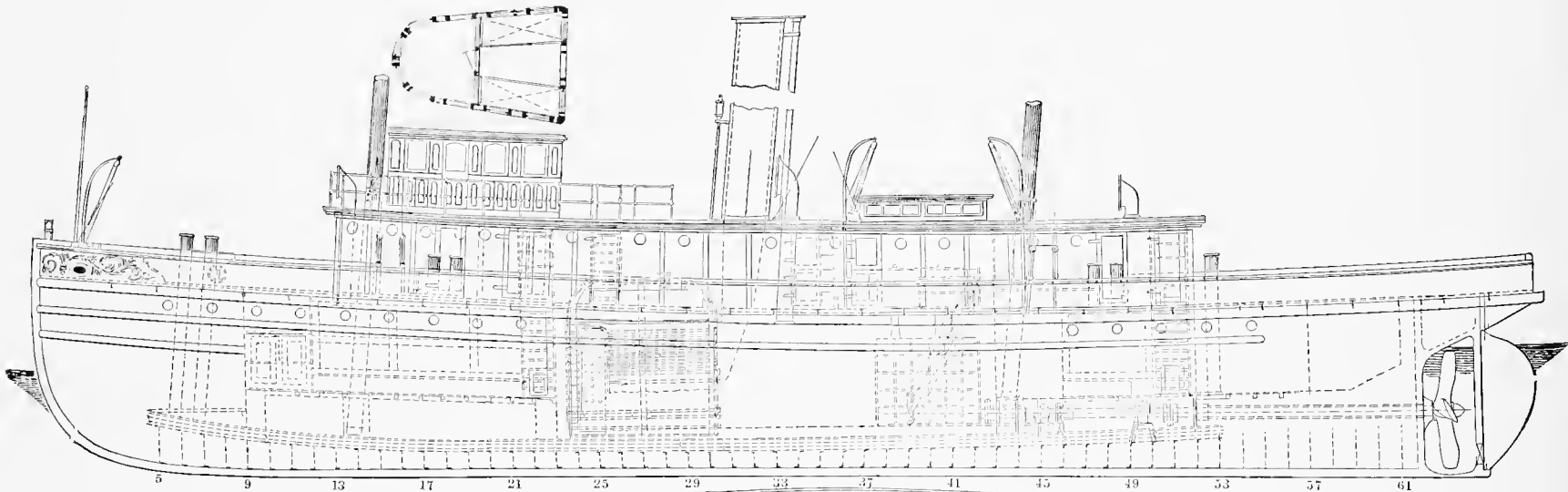
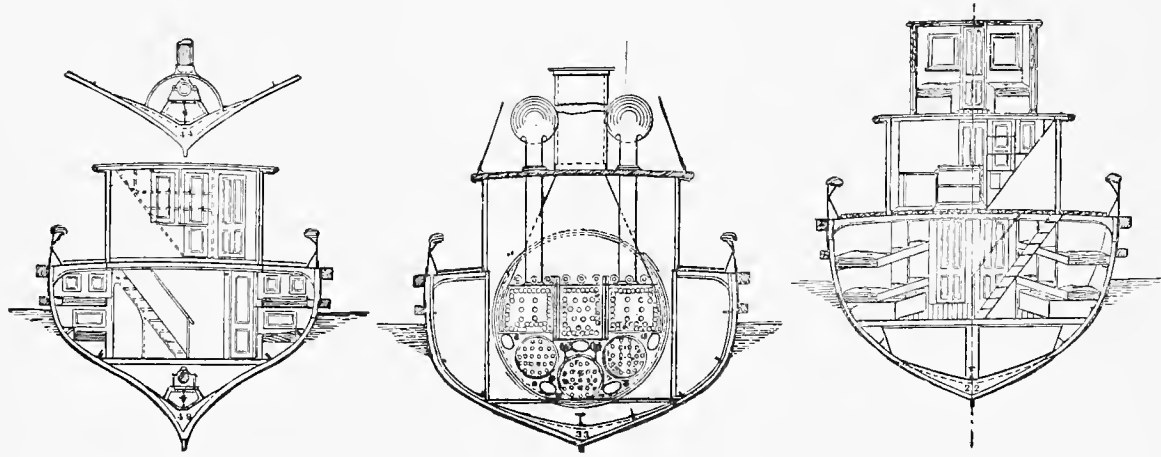

PLANS FOR AN IRON TUG.—Designed by Henry J. Gielow, New York.

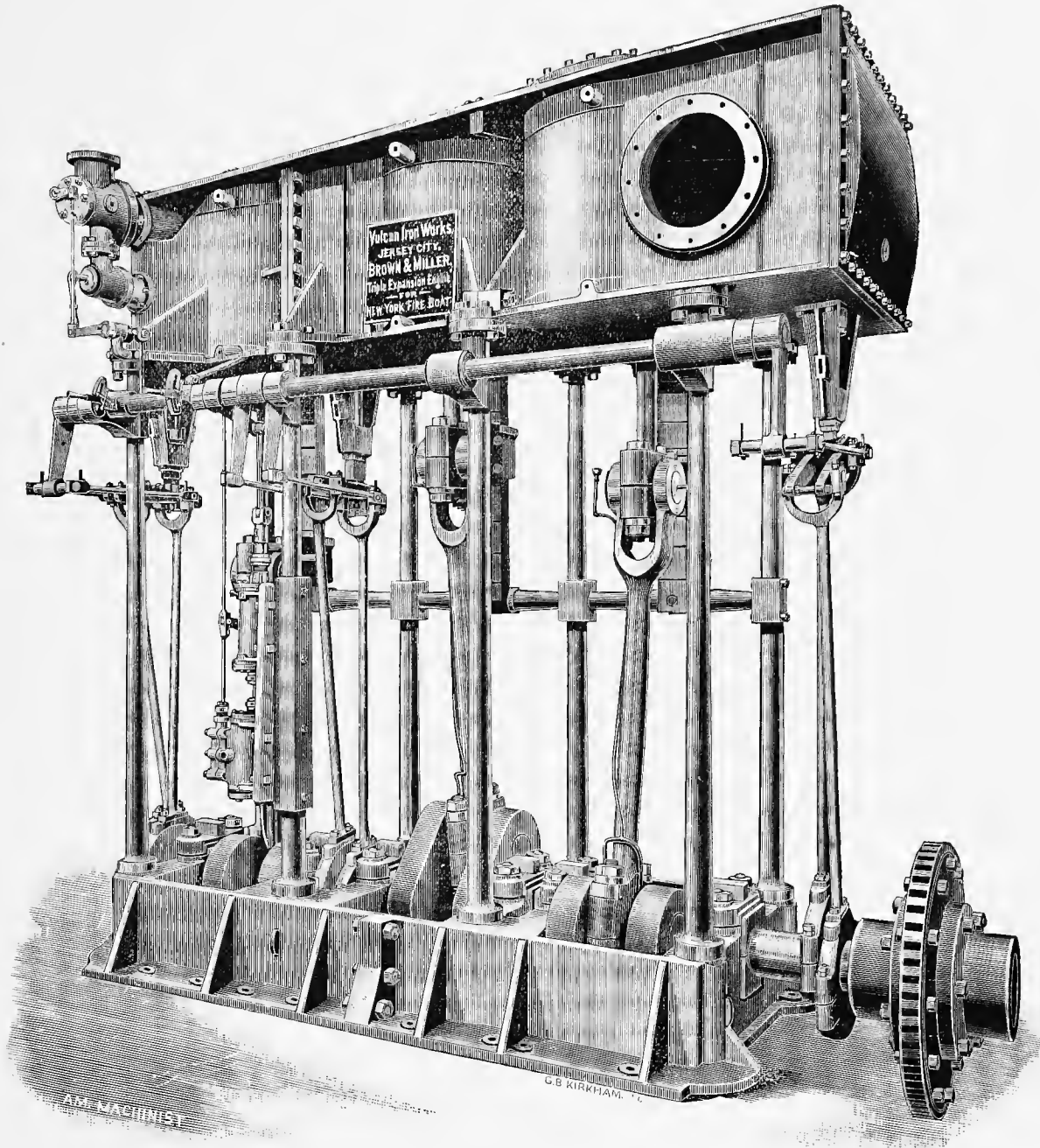

TRIPLE-EXPANSION ENGINE OF THE FIRE BOAT NEW YORKER.

Gloucester, Mass., a distance of thirty miles, which is made by the new boat in one hour and forty minutes. The Cape Ann was launched on April 6, 1895. She was constructed in five months. The Cape Ann has a speed of 16 knots, carries 1,000 passengers and is 185 feet long, 29 feet beam and 13 feet deep. She is propelled by a vertical inverted compound engine 25 and 50 by 30 inches, running at 145 revolutions per minute, indicating 1,500 horse-power. Her screw is of the built-up style, 9 feet 8 inches in diameter. The steel boilers are of the Scotch type, two of them being 10.8 feet by 12.2 feet, while the third

is 11.4 feet by 12.2 feet, carrying a steam pressure of 125 pounds. Each boiler has two corrugated flues, forced draught being used. The fire-room is air-tight and worked under pressure, air being supplied by a special steam fan, delivering 25,000 cubic feet of air per minute. All pumps are independent. Her hull is built of steel throughout. She has main, saloon and hurricane decks; there are five water-tight bulkheads. The steamer has a freight capacity of 500 tons. She carries a crew of 20 men. Her cost was about \$100,000.

Plans and Specifications for an Iron Tug.

The accompanying illustrations show the general outline of an iron tugboat, and the general arrangement of its machinery. We believe the design to be a good one, and the following data in connection with the cuts will be useful to some of our readers as matter of reference in designing similar boats. The general dimensions of the hull are: Length over all, 118 feet; length on water line, 111 feet 4 inches; extreme breadth of beam, 22 feet 3 inches; depth of hold amidships, 11 feet 6 inches; load draught of water aft, 10 feet 3 inches; least freeboard, 3 feet 7 inches. The boat is to be driven by an inverted cylinder surface-condensing compound engine, with two cylinders and cranks at an angle of 90 degrees. The cylinders to stand fore and aft of each other, the high-pressure cylinder to be the forward one. The center of low-pressure cylinder to be 12 inches forward of frame No. 41, and the center of the shaft to be 4 feet 7 inches below the designed water line on frame No. 41.

High-pressure cylinder is 20 inches diameter, and low-pressure cylinder 40 inches diameter; both for a 26-inch stroke of piston. Steam ports of high-pressure cylinder not to be less than 24 square inches, and exhaust not less than 48 square inches; the low-pressure cylinder is to have double steam ports having a combined area of 102 square inches, and an exhaust area of 136 square inches. The lower ends of the cylinders to be fitted with a small bonnet with stuffing box and gland, both bushed with composition; also a brass drain valve 1 inch diameter with copper pipes. Bedplate is to be of cast-iron in one piece, composed of two fore-and-aft box girders 16 inches square, and three transverse box girders 10 inches wide and 16 inches deep. Fore-and-aft girders to have open bottoms, and transverse girders to be shaped to receive pillow blocks, etc. All necessary flanges, bosses and lugs for condenser, air-pump, etc., to be cast on, and all surfaces for flanges and connections to be planed. A light cast-iron or wrought-iron pan to be fitted under each crank to receive oil and drip from journals. The main frame for carrying the cylinders on port side will be the surface condenser; cast-iron frames above having flanges and through bolts at cylinders and condenser, and crosshead guides, 8-inch face, cast on to the inside. On starboard side will be two rectangular cast-iron box columns 9 by 10 inches at cylinders, and 14 by 14 inches at bedplate.

Steam chests to be cast separate, fitted with face joints, and well bolted to cylinders. The high-pressure steam chest is to be fitted with a screw valve $2\frac{1}{2}$ inches diameter, for a pass-over valve, with copper pipes, and all necessary fittings and connections. Valve, seat and stem of composition. Each steam chest is to be fitted with a 1-inch relief valve of composition, with copper connection to condenser. A relief valve, set at 45 pounds, is to be fitted on low-pressure steam chest. Slide valves to be of the ordinary D form, made of cast iron of as different texture from the iron of the seats as possible, and scraped to a tight bearing surface. A Meyer cut-off valve is to be fitted on back of high-pressure valve, worked by a separate eccentric, with right and left-hand screws for adjusting the point of cut-off. Suitable hand-wheel for operating and an indicator plate, graduated to show the point of cut-off, is to be provided. Intermediate receiver is to be of copper pipe 10 inches diameter, and of sufficient thickness to stand a working pressure of 50 pounds; to have composition flanges, faced, with backing flange to which the pipe is to be riveted and brazed.

The valves are to be worked by a Stephenson link motion; the link to be of the "double-bar" pattern, with a throw of about 15 inches; to be made of machinery steel, $2\frac{3}{4}$ inches deep and $1\frac{1}{8}$ -inch face. Main eccentrics to have $2\frac{1}{2}$ -inch face, and cut-off eccentric 2-inch face. Eccentric rods to be made of machinery steel. Pistons to be of cast iron, double shell, properly ribbed, with cast-follower fastened with steel bolts screwed into brass nuts. Packing rings to be of cast iron, in two thicknesses, and set out with steel springs. Piston-rods to be of mild steel $3\frac{1}{2}$ inches diameter. Each crosshead is to have two journals $3\frac{3}{4}$ inches diameter and $4\frac{1}{4}$ inches long. On each side of crosshead there will be a brass slipper fitted with taper liner and suitable nut and bolt for making adjustments for wear. The wearing surface of the brass slippers not to be less than 96 square inches each. Connecting-rods to be of the best hammered iron. Crank-shaft pillow blocks to be fitted with composition boxes babbitted. Forward journal 10 inches long; intermediate journal 18 inches long and after journal 15 inches long; all to be 8 inches diameter. Crank shaft to be forged in one piece. The bearing surfaces in thrust bearing to have a maximum pressure of not more than 40 pounds per square inch. Counterbalance wheel to be of cast iron, well fastened to after end of crank shaft; to be fitted with suitable notches so as to serve as a "pry-off" wheel when required, and also to serve as one disk of coupling. Surface condenser to have a cooling surface of 1,000 square feet, measured on outside of tubes; cast-iron shell 1 inch thick, and to have a length of about 8 feet 1 inch between flanges. Midway between the tube heads, longitudinally, a cast-iron plate will be fitted and secured to shell to support the tubes and keep them from chattering. Tube heads to be of composition not less than $1\frac{1}{4}$ inch thick, and bolted in place with yellow metal or composition standing bolts. Tubes to have cotton packing compressed with suitable glands or followers. Tubes to be $\frac{5}{8}$ inch in diameter, tinned inside and out, and arranged in two nests or sets, so that the refrigerating water will pass twice through tubes. A suitable brass cup or valve is to be fitted for introducing soda to the condenser. Air-pump to be vertical, single acting, 19 inches diameter and 12 inches stroke, worked from a low-pressure crosshead by means of suitable levers and links. Valve seats to be of grating form and valves of pure rubber. Hot-well to be cast on air-pump, concentric with body of pump and fitted with feed-water connections and outboard delivery. The feed water to be led to a galvanized iron receiving tank from which the feed-pump will draw its supply. Receiving tank to hold not less than 500 gallons, and to be fitted with approved filter for separating oil and grease from water. The circulating-pump is to have a capacity of not less than 600 gallons per minute at ordinary speed, with suitable sized steam cylinder and direct connection. Feed-pump to be No. 4 Knowles' patent pressure pump, $5\frac{1}{2}$ -inch steam cylinder, $3\frac{3}{4}$ -inch water cylinder, both with a stroke of 7 inches. A pipe heater is to be fitted between engine and condenser, through which exhaust steam will pass from low-pressure cylinder to the condenser for increasing the temperature of the feed-water. There will also be fitted one No. 7 Korting Universal injector, with connections to receiving tank and fresh-water tank. A bilge ejector is to be furnished, with proper connections for siphoning water from any compartment at will. Propeller wheel is to be of cast iron, four-bladed, 9 feet diameter, and fitted on shaft with fore-and-aft-key, and a large cap outside with keeper. Boiler to be of the Scotch type, 12 feet 6 inches in diameter, 12 feet long. To be made

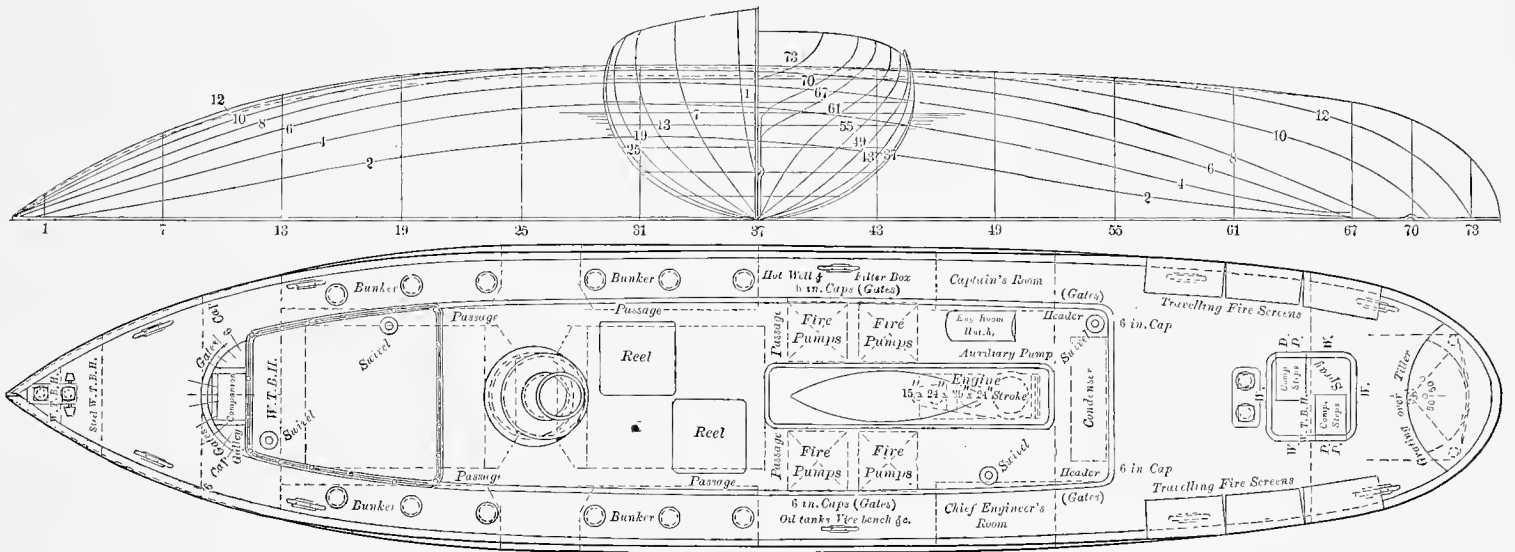
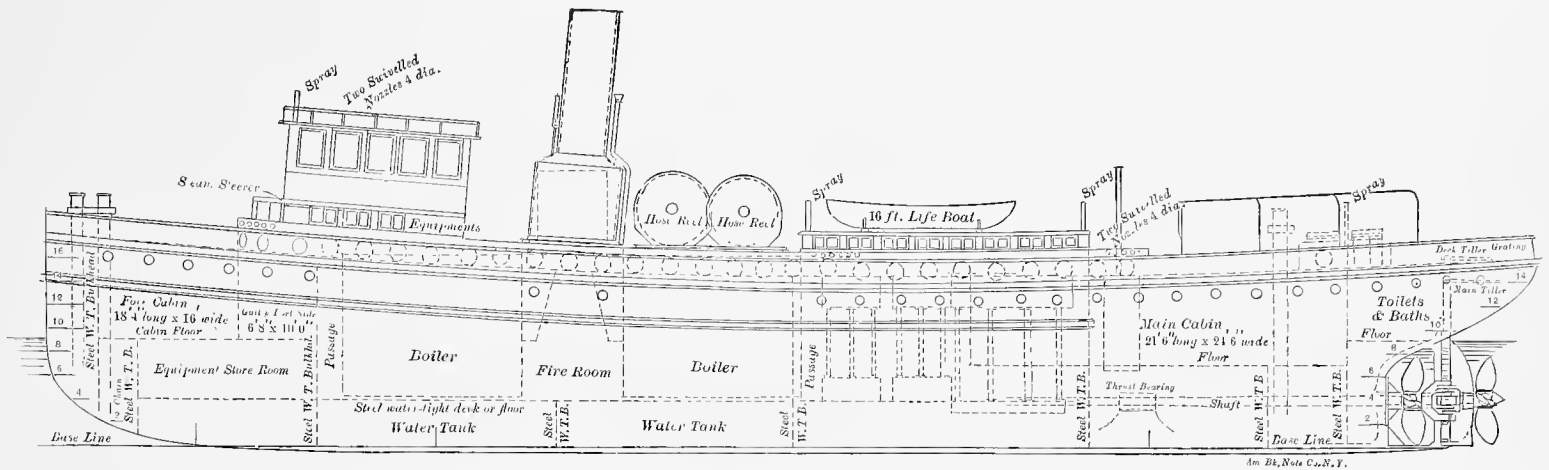

GENERAL PLAN OF THE FIRE BOAT NEW YORKER.

of Siemens-Martin steel. It is to have three Fox's patent corrugated furnaces 36 inches clear inside diameter, and 8 feet 11 5/8 inches long. American lap-welded boiler tubes, 248 in number, 3 inches diameter, 8 feet 10 1/2 inches long, spaced not less than 4 inches between centres; 72 of these tubes to be stay pipes. Back connections to be 2 feet 5 1/2 inches long at bottom and 2 feet 2 1/4 inches at top, to be arranged in three separate compartments, each connected with its proper furnace. Grate bars of cast-iron in two lengths, each about 3 feet 7 inches long.

The material of hull is to be iron capable of withstanding a tensile strain of 45,000 pounds per square inch with and 40,000 pounds across the grain. Keel to be formed of a bar of hammered iron 6 1/2 by 2 inches, forged in as long lengths as

possible with scarfs 18 inches long. Stem of hammered iron 6 1/2 by 2 inches from keel to load water line, gradually diminishing to 4 1/2 by 2 inches at head. Stern post of hammered iron 6 1/2 by 2 1/2 inches, with suitable eye and hub forged on for stern pipe and screw shaft. The rudder post to be 5 by 2 1/2 inches, with shoe or boss at lower end for foot of rudder stock. Frames to be of angle iron 3 by 3 3/8 inches, spaced 21 inches between centres, all to extend in one length from keel to gunwale. Bulkhead frames to be double. Intermediate frames, same size, to be worked in center of each frame space, from stem to frame No. 22, to extend from keel to about 3 feet above load water line. This boat was designed by Henry J. Gielow, engineer and naval architect, New York.

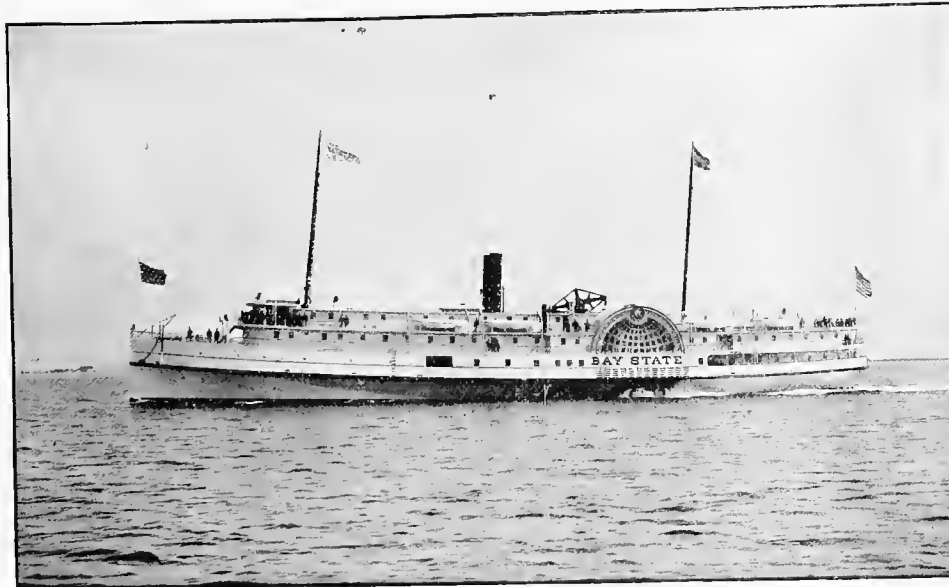

BOSTON AND PORTLAND LINE STEAMER BAY STATE.

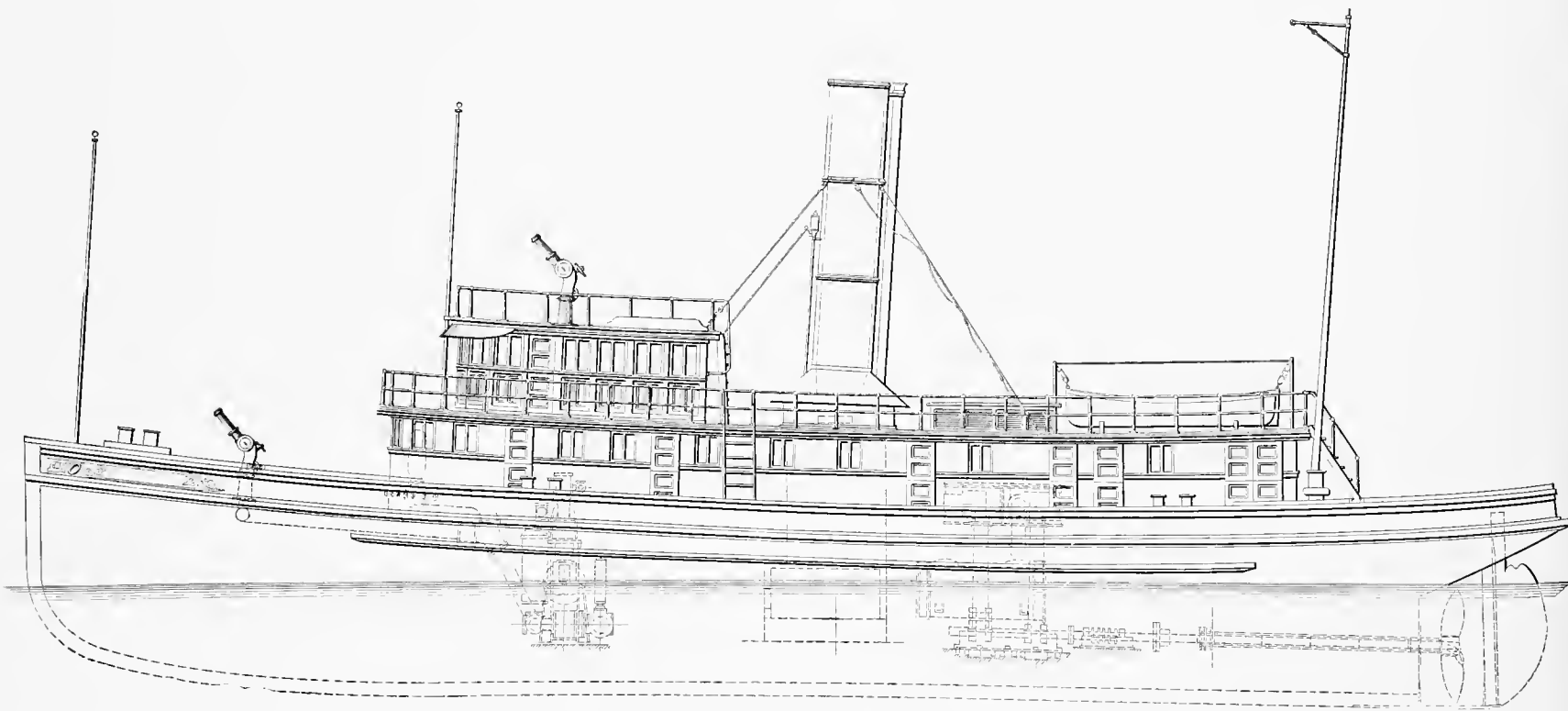

THE NEW WOODEN FIRE BOAT FOR THE CITY OF BOSTON.—Built by John M. Brooks, East Boston, Mass.

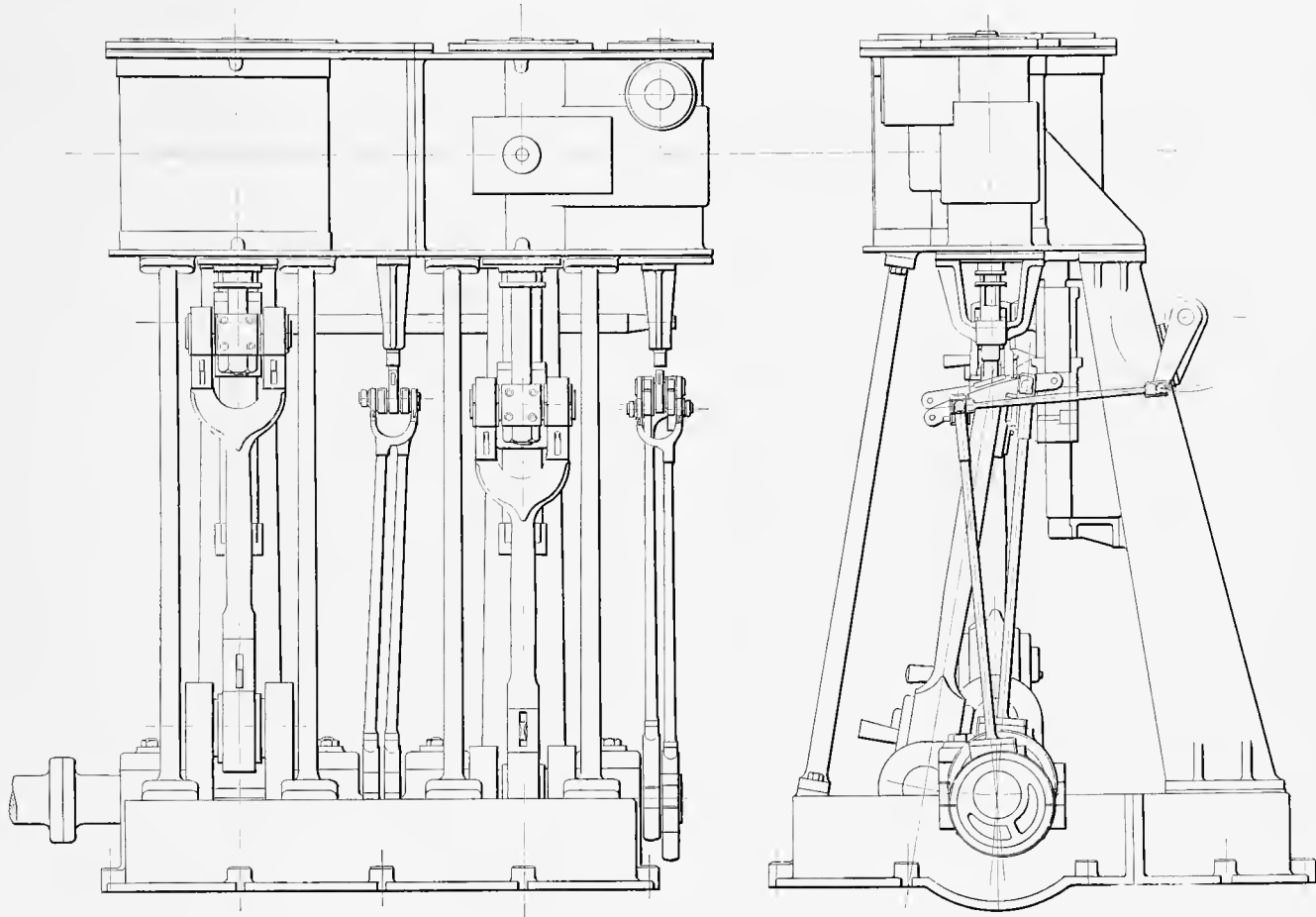

COMPOUND ENGINES OF BOSTON'S NEW FIRE BOAT.—Built by Brown & Miller, Jersey City, N. J.

Engines of the Fire Boat New Yorker.

The cut on page 41 shows the triple-expansion engine of the fire boat New Yorker. The cylinders are 15, 24 and 39 by 24 inches. The illustration represents the engine without the lagging. The cylinders are lagged with magnesia.

For the high-pressure cylinder a piston valve is used; the valve seat is bushed with steel. The area of the steam port is 15 square inches, and that of the exhaust port 30 inches. For the intermediate cylinder a slide valve is used; area of steam port, 40 square inches, and that of exhaust port, 80 square inches. The low-pressure cylinder is provided with a double-ported slide valve; the combined area of the steam port is 100 square inches, and that of the exhaust 200 square inches.

The Fire Boat New Yorker.

This iron boat was built in 1890 by the Johnson Engineering Works, Harlem, N. Y., from plans of Wm. Cowles. The hull is 125 feet long, 26 feet beam and 14½ feet deep. Her engines were built by Brown & Miller, Jersey City, N. J., and the steam generators by the Franklin Boiler Works, Greenpoint, L. I.

Boston and Portland Steamer Bay State.

The hull of this boat was constructed by the New England Co., of Bath, Me. She is owned by the Portland (Maine) Steam Packet Co., and is on the route between the latter place and Boston, Mass. The Bay State bears a striking resemblance to her consort the Portland, but is built in a more substantial manner and her model is much finer. The hull is as follows: Length over all, 292 feet; breadth of beam, 42 feet; over guards, 68 feet; depth of hold, 16 feet; gross tonnage, 2,211.01; net tonnage, 1,537.63. A heavy hog frame extends almost the entire length of the boat, reaching to the second deck. It is diagonally braced and strapped with iron.

The vertical beam engine was built by the Portland Co., of Portland, Me. The diameter of cylinder is 62 inches; length of stroke, 12 feet. The Portland Co. also furnished the two steel flue and return tubular boilers. They are in length 23²/₃ feet; diameter, 144 inches; tensile strength, 55,000 pounds; steam allowed, 50 pounds per square inch; flues in each boiler, 2; tubes in each boiler, 180; the longitudinal seams are double-riveted. There are 146 staterooms and 216 berths, which will accommodate 700 people. The paddle-wheels are of the Mahoney type, and are 35 feet in diameter.

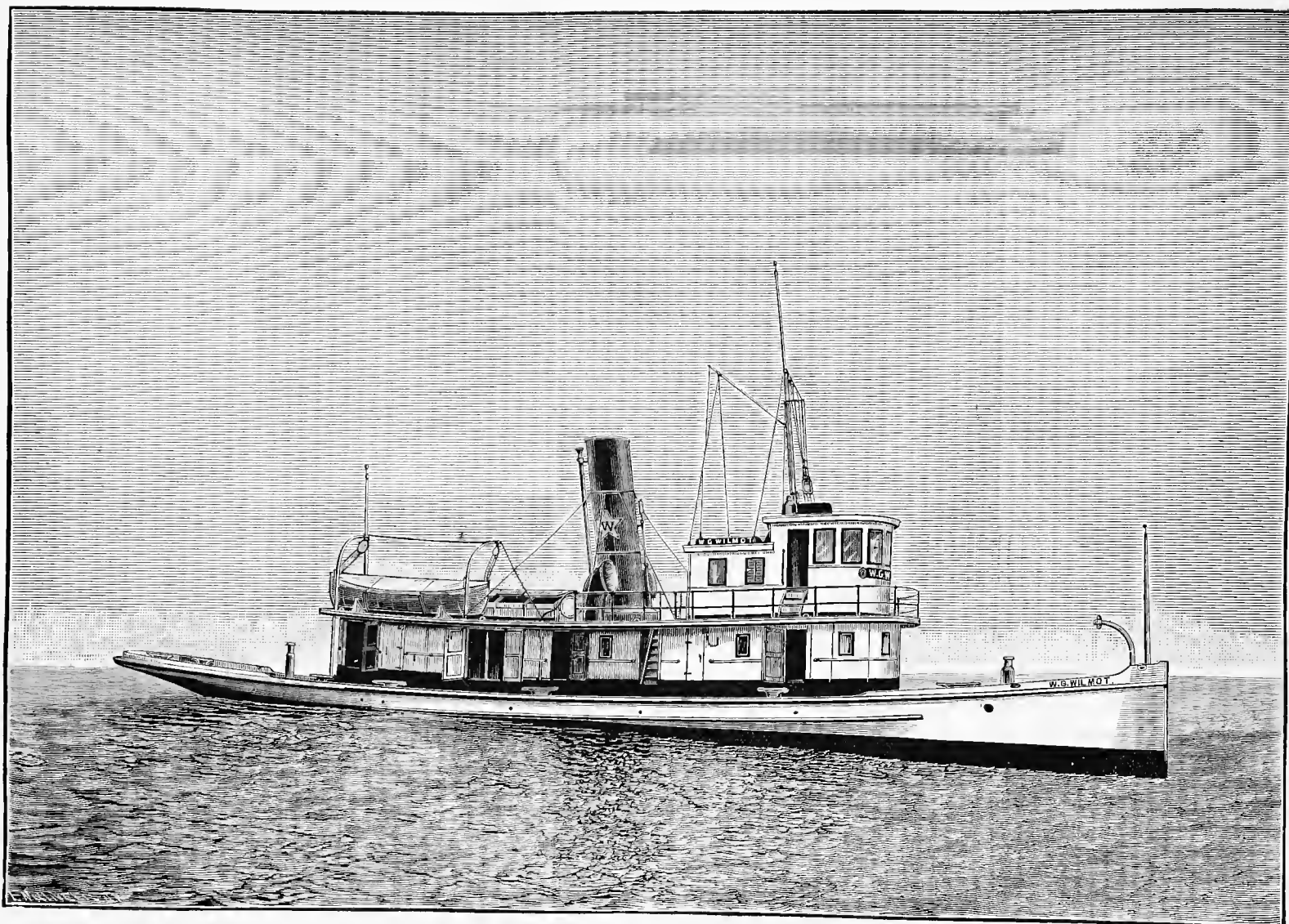

THE STEEL TUG W. G. WILNOT.—Built by F. W. Wheeler & Co., West Bay City, Mich.

The Boston Fire Boat No. 44.

The hull of this boat is of wood (iron would certainly have been better for a fire-fighting machine such as she is). Length, 110 feet over all; breadth of beam, 26 feet over plank; depth of hold from top of ceiling to top of deck beam, on frame 3, 10 feet; draught, 8 feet 6 inches. The hull and joiner work were built by John M. Brooks, of East Boston, and engines, boilers and all machinery, except fire-pumps, by Brown & Miller, Jersey City, N. J. The engines are of the vertical inverted cylinder, direct-acting, compound type. The high-pressure cylinder is 18 inches diameter, low-pressure 36 inches diameter, and 24 inches stroke. The high-pressure valve is of cast iron of the piston type; the low-pressure valve is a double-ported

slide valve; and both are proportioned for a piston speed of 540 feet per minute. The valve gear is of the Miller patent cut-off type, with double-bar links. Eccentrics and straps of cast iron, and eccentric rods of wrought iron fitted with straps, gibs, and keys where attached to the links. Valve stem guides are of cast iron and secured to the cylinders, and they are fitted with gibs adjusted with slips. The reversing engine is the Miller patent steam reverse type; cylinder 7 inches diameter. The framing consists of two cast-iron columns on the rear side of the engine, fitted with water slides; and four wrought-iron columns on the front side of the engine. The bedplate is of the box type, 14 inches deep under the boxes, and fitted with four main bearings.

The condenser is of cast iron, circular in form. Cooling

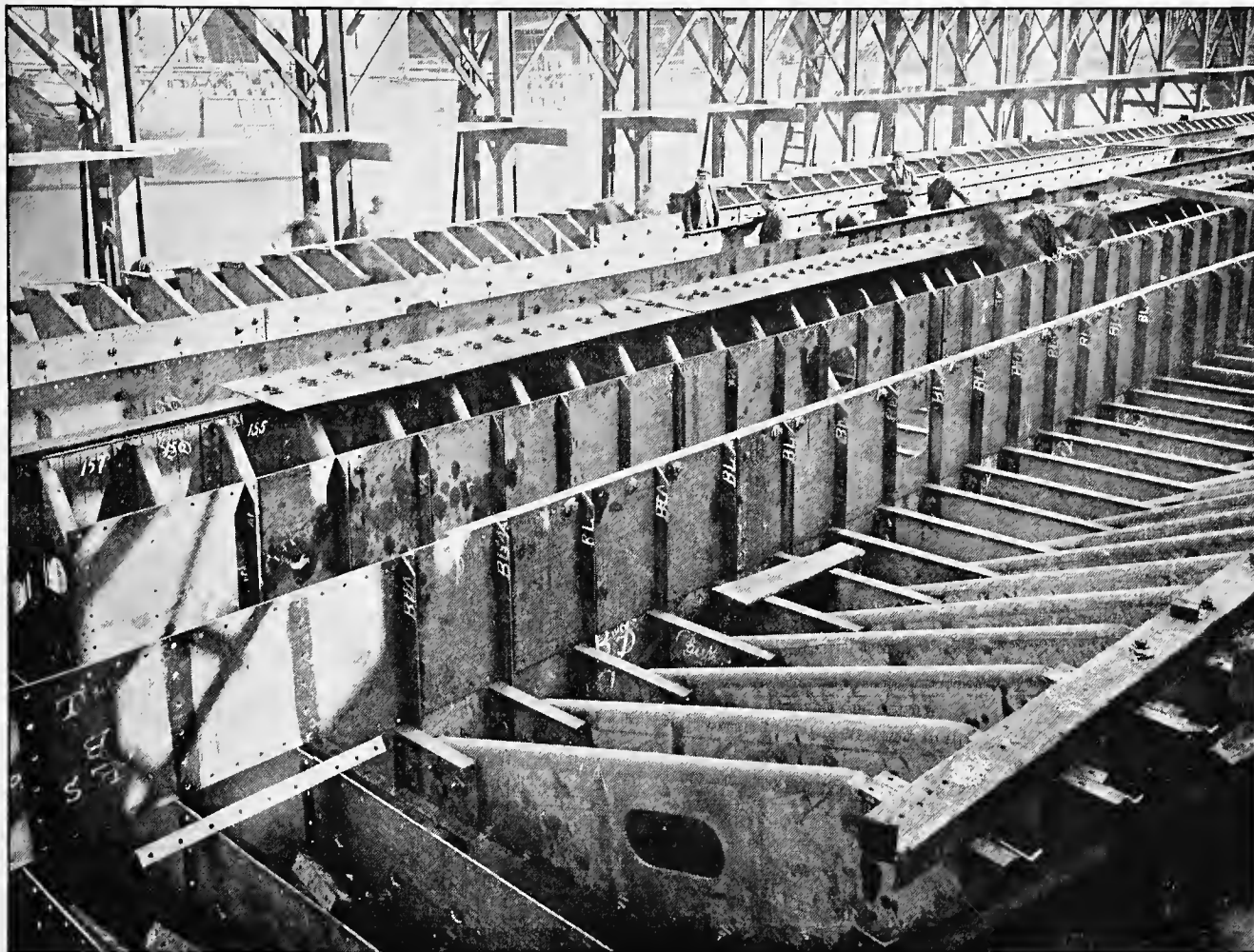

STUART'S CHANNEL SYSTEM OF CONSTRUCTION.—Showing keel, keelsons, intercostals and floors.

surface, 1,100 square feet; brass tubes tinned inside and out; tube sheets of composition; the cooling surface being commensurate with the power of the boiler. The latter being calculated to supply steam to propelling engine while fire-pumps are in operation. The independent air and circulating-pump has a steam cylinder 12 inches diameter, air cylinder 14 inches and water cylinder 14 inches diameter, all 12 inches stroke.

The propeller is of the built-up type, 8 feet diameter, 12 feet pitch. There are two boilers of the vertical type built for a working pressure of 120 pounds per square inch. Thickness of shell, $\frac{1}{2}$ inch; crown sheets, $\frac{1}{2}$ inch; tube sheets, $\frac{1}{2}$ inch; furnace, 11-32 inch; smoke box, 7-16 inch; all of Siemens-Martin steel. Each boiler contains 542 lap-welded iron tubes 5 feet long, 2 inches diameter, expanded and beaded over at both ends.

There are two vertical fly-wheel duplex fire-pumps, double acting, furnished by American Fire Engine Co., of Seneca Falls, N. Y., with steam cylinders of the compound type.

Steel Tug W. G. Wilmot, of New Orleans.

This boat, named after her owner, is of steel throughout and of the following dimensions: Length over all, 110 feet 6 inches; beam, 23 feet; extreme draught, 11 feet; the engines are triple-expansion, with cylinders 16, 24, 40 inches by 28 inches and drive a screw 9 feet 3 inches by 12 feet. The high-pressure cylinder has a piston valve; the other two cylinders have slides, worked by link motion, which is handled by steam reversing gear.

The boiler is of the Scotch type, 12 feet 6 inches diameter by 12 feet 8 inches long, with three furnaces 40 inches diameter by 8 feet long; the grate area is 63 square feet; heating surface, 2,000 square feet. On her trial trip, in Saginaw Bay, the Wilmot made 16 miles per hour under partial power, developing 700 indicated horse-power on 160 pounds of steam, and 125 revolutions per minute. She was built in 1892 by F. W. Wheeler & Co., West Bay City, Mich.

Stuart's Channel System of Construction.

The channel iron system of construction is excellently shown in the accompanying illustration, which pictures the methods employed in the building of a large steel steamer on the lakes. There has been a good deal of controversy pro and con upon the merits of this system, as compared with the old style of using angle irons on steel plates. The channel system is the invention of Sinclair Stuart, Ship and Engineer Surveyor to U. S. Standard Steamship Owners', Builders' and Underwriters' Association, Limited, British Corporation for the Survey and Registry of Shipping, and United States Lloyds, New York, and has been used in the yards of the Cleveland Shipbuilding Co., the Chicago Shipbuilding Co., and others. The channel system certainly saves a large amount of riveting, and its advocates claim that it gives the ship a greater rigidity where it is most needed, and where rivet heads shear off most.

The saving in rivets is effected by riveting the flanges of the channeled iron together direct instead of using angle pieces. The illustration shows the turn of the bilge in the foreground, no frames being yet set up. The frames will at-

tach where the temporary wooden stringer is seen. The cut shows more clearly than any description of the work that might be written how these channel shapes are used for main frames and floor plates, instead of angle iron and plates riveted together to form the desired shape.—Cleveland *Marine Record*.

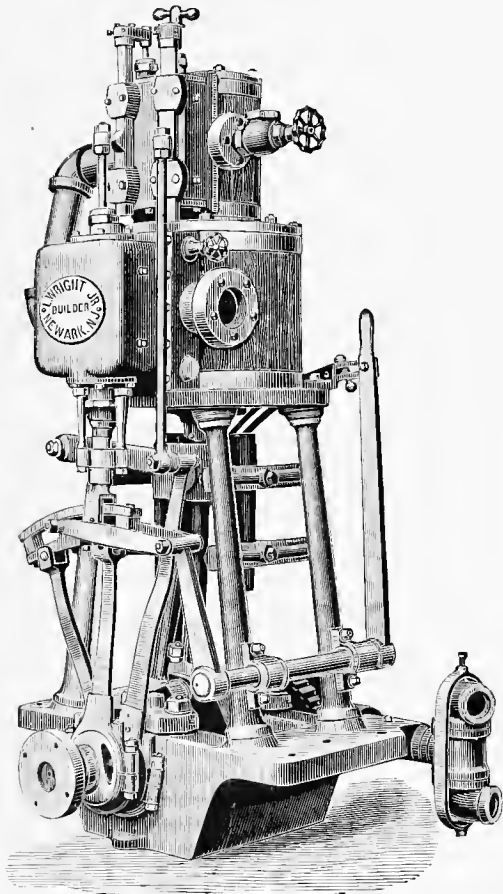

WRIGHT'S LAUNCH ENGINE.—6½, 13 x 8.

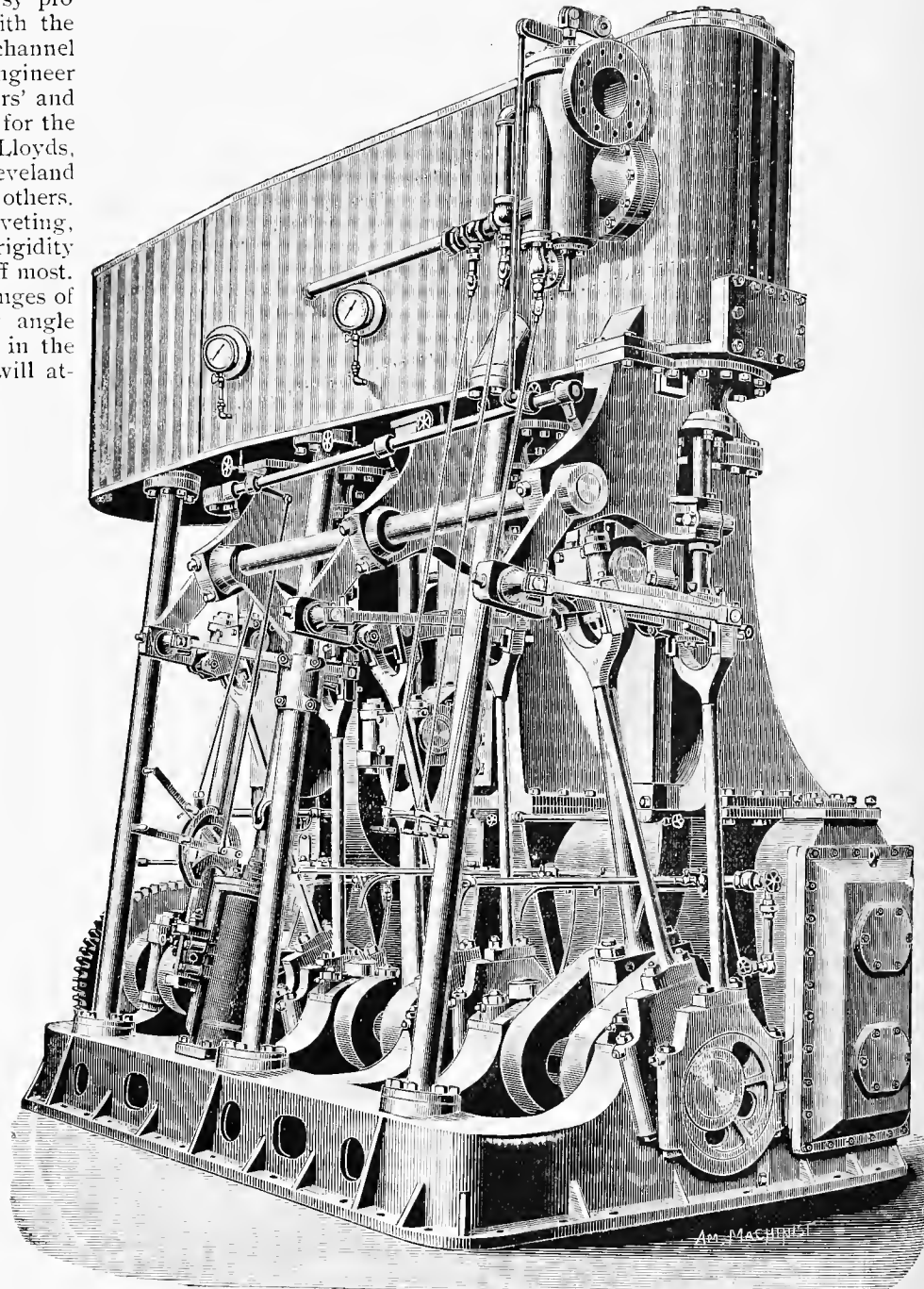

TRIPLE-EXPANSION ENGINE OF THE BRIDGEPORT LINE STEAMER NUTMEG STATE.

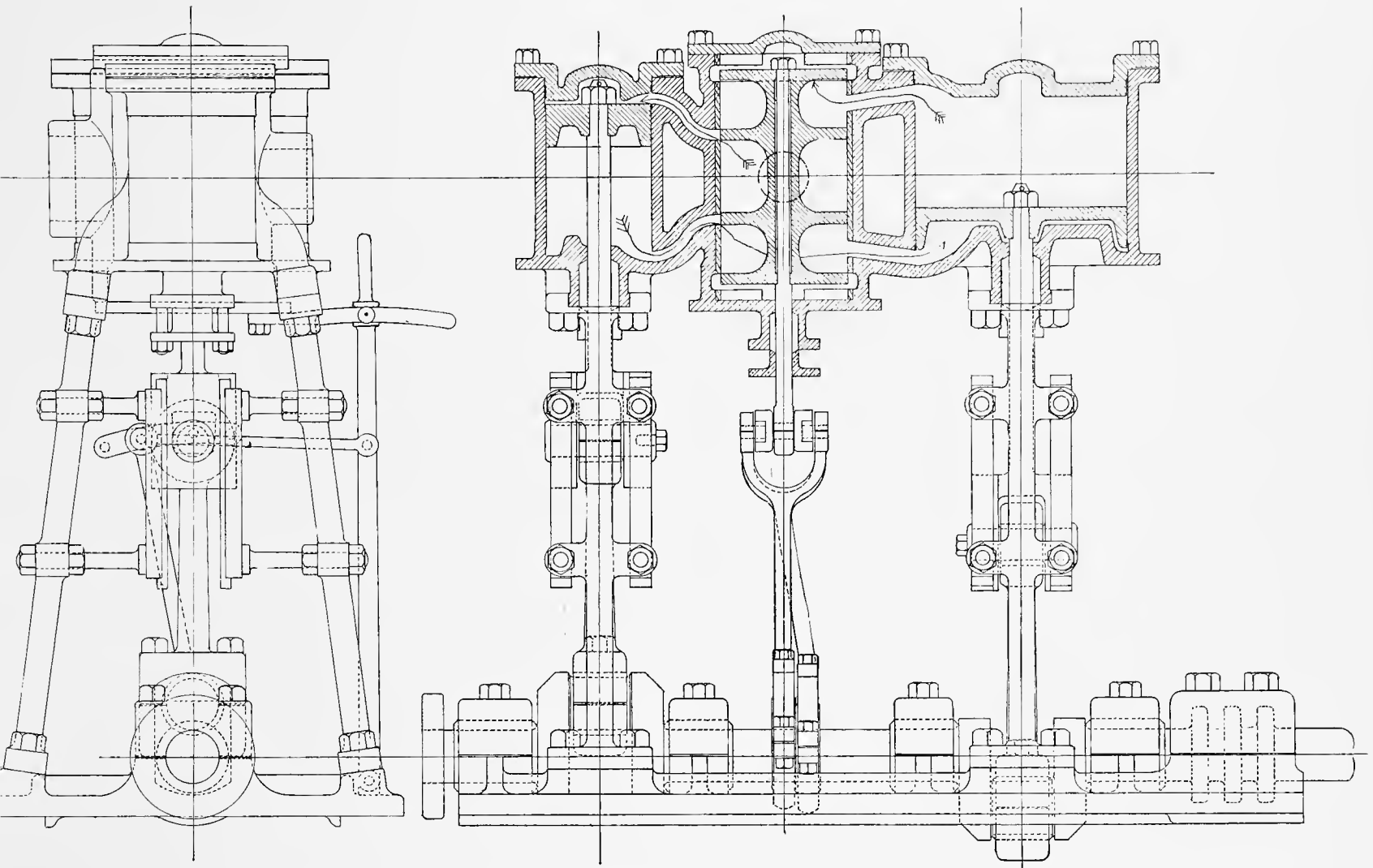

CHAPIN'S PATENT COMPOUND LAUNCH ENGINE.—Designed by John J. Chapin, Youkers, N. Y.

Engine of Steamer Nutmeg State.

The steamer Nutmeg State was built in 1892 for the Bridgeport Steamboat Company, and is now engaged in the passenger and freight service between New York and Bridgeport, Conn. Her engines are triple-expansion, 18, 27 and 42 by 26 inches. At the front side the cylinders are supported by three wrought-iron columns $4\frac{1}{2}$ inches diameter, and at the rear side by three cast-iron columns bolted to the top of condenser, which forms part of the framing. The cooling surface in condenser is 1,600 square feet. A single-acting air-pump is bolted to the condenser and worked by a lever, which receives its motion from low-pressure crosshead. The diameter of air-pump is 21 inches. For the distribution of steam in the horse-power cylinder a piston valve $10\frac{1}{2}$ inches diameter is used; and double-ported slide valves perform the same office for intermediate-pressure and low-pressure cylinders. Steam ports in the intermediate-pressure cylinder are 3 inches

wide and 20 inches long; in the low-pressure cylinder they are 3 inches wide and 38 inches long. These valves are actuated by the ordinary Stephenson link motion, the links being of the double-bar type, and the motion reversed by steam. The diameter of the reversing cylinder is 8 inches. The pistons are of cast iron, fitted with the ordinary cast-iron packing rings held out by steel springs. Diameter of piston-rods, $3\frac{7}{8}$ inches; diameter of connecting-rods, crosshead end, $3\frac{5}{8}$ inches; crank pin end, $4\frac{1}{8}$ inches diameter; crosshead pin, $4\frac{5}{8}$ inches diameter; crank pin, $8\frac{3}{8}$ inches diameter and 9 inches long; main journals $8\frac{5}{8}$ inches diameter and 12 inches long; crank webs, $6\frac{1}{4}$ inches thick and $16\frac{1}{2}$ inches wide. A worm and wheel is attached to the end of the crank shaft for turning the engine by hand. Diameter of propeller, 9 feet 10 inches; pitch, 14 feet; number of blades, 4. Feed and bilge-pumps are worked from the air-pump crosshead. The circulating-pump is an independent one. The engine develops 1,000 horse-power; total consumption of coal, 1,600 pounds per hour. Steam is supplied by

two cylindrical boilers 9 feet 4 inches diameter and 20 feet long; each contain two furnaces 47 inches diameter. Total grate surface, 100 square feet; working pressure, 160 pounds. The hull is built of wood; length on water line, 183 feet; breadth, 34 feet; mean draught, 9 feet; displacement, 960 tons. There are 38 staterooms and a ladies' cabin on the saloon deck, and 36 berths for cabin passengers below the main deck. The engines were built by John W. Sullivan, New York, and the hull by Robert Palmer & Sons, Noank, Conn.

Chapin's Compound Launch Engine.

The engine herewith shown is a single-valve compound, having cylinders 5 and 10 inches and 5 inches stroke. The cylinders, steam chest and bottom heads are a single casting. The steam chest is made very large in diameter in proportion to the cylinders, in order to get large port area with a minimum of valve travel, also to make a receiver between the high-pressure and low-pressure cylinders. The cranks are placed directly opposite, the object of the receiver being to do away with the shock and pound in the low-pressure cylinder, common in engines exhausting directly from high-pressure into low-pressure cylinder when running at a high rate of speed. The valve is in one casting, consisting of four discs on a central column. Steam enters the chest between the two inside discs, the course of the steam being shown by the arrows. The exhaust ports at the top and bottom of the steam chest run into each other at the back of the chest, and the exhaust steam is carried away by one pipe. The steam pipe is 2½ inches diameter and the exhaust 3½ inches. The steam chest is fitted with a cast-iron liner. The liner has bridges across the exhaust ports, and pieces cut out from either end of the liner into the exhaust ports. The object of the latter is to open a passage between the ends of the valve and the chest heads to prevent any choking, making the valve perfectly balanced at all times. The valve here shown is designed with very little lap, and is intended to admit steam during about 4¼ inches of the stroke. Both pistons are fitted with two self-setting spring rings, and are attached to the rods by a driving fit to a shoulder and a nut with split pin above. The high-pressure piston is cast heavy and weighted to equal that of the low-pressure. The rods and crosshead being the same weight and the cranks being set opposite, the whole engine is in perfect balance. The cylinders are carried by four cast-steel columns set on an incline. The high-pressure cylinder has lugs cast on each side and a web running half way up the wall of the cylinder, and the low-pressure has bosses cast on bottom head to receive the columns. The latter have a T on each end and are bolted to cylinder and bedplate by two bolts. The crosshead and piston-rod are of steel in one piece, the crosshead being extra long, running on flat guides. The latter are carried by horizontal columns going through T's on the main columns, with a nut on each side. The opposite guides are connected, but not shown in drawing, tying the columns together, making a light and very rigid frame. The guides are fitted with brass slippers. The connecting-rods are 12½ inches between centers, having eyes in the upper end with solid brass bushings pressed in. The lower end has the regular box. The crank shaft is of steel 2½ inches diameter. There are four main bearings, two 4 inches and two

3½ inches long, all fitted with brass bushings. The reversing gear is the regular double-bar link motion. The go-ahead eccentric rod is straight, the off-set coming altogether on the back-up rod. The top cylinder heads have a ⅜-inch ground joint. The guides are adjustable by the nuts of the columns. The thrust has three collars running in a bearing cast on the bedplate. The thrust bearing is babbitted. The bedplate is cast iron, very strong and light. The engine was designed to meet specifications calling for a compound engine of the given size cylinders, to make 750 revolutions and occupy little space. The crank shaft, set as it is, does away with all pocketing of steam in the receiver, to be held there in compression till the low-pressure piston is in a position to take it; but the instant the high-pressure cylinder has finished with its steam, the low-pressure is ready to take it without further compression, increasing the efficiency of the engine besides making a very nice balance. Steam enters the chest and is delivered direct into the high-pressure cylinder; after it has done its work there, it is delivered almost in a straight line across to the low-pressure and from there into the condenser. Although two cylinders are run with one valve, the port passages are no longer than other engines and shorter than most. The valve is very simple, finished in one setting in the lathe, making it very cheap to build, and, at the same time, a good job. There are no difficult or delicate parts about the engine, and is very easy to handle. The speed at which engines of this type can be run surprises all who see them. This engine was designed by John J. Chapin, Yonkers, N. Y., and is fully covered by patents.

Burrell-Johnson Compound Marine Engine.

The cut represents the 16 and 28 by 18 inches and 14 and 26 by 18 inch sizes of the tandem compound surface-condensing marine engine, built by the Burrell-Johnson Iron Co., Yarmouth, Nova Scotia. The steam cylinders are cast with receiver, and connected between the two with flanges, and form a reservoir for the steam from the high-pressure to the low-pressure cylinders. The condenser at the back and steel columns in front form the frame. The bedplate is of the hollow box pattern, and fitted with bush metal boxes, babbitted lined, and have good, large and long bearings for crank shaft. The connecting-rods are of forged steel, fitted with bush metal boxes, babbitted lined. The crank shaft is also of forged steel, made solid, with cranks cut out at right angles, with large crank pins. All eccentric rods and other parts have a convenient and practical way for taking up wear. Propeller shaft is of forged steel, with brass sleeves, shrunk and screw pinned on shaft, where working through stern bearing and stuffing box. The pumps are all worked independently of the engine, and can be regulated to run at the speed required, and have the advantage of the vacuum when starting the engine. The latter is fitted with steam reversing gear which works with perfect ease, and as quickly as desired. The cylinders are covered with non-conducting material and lagged with walnut, cast iron or mahogany, and fitted with heavy brass bands, or nickel-plated if desired. The engines are built for 125 pounds steam pressure, and will run 140 revolutions per minute with all safety. The engine illustrated is now running in the passenger propeller Weymouth, the dimensions of which are as follows: Length, 104 feet; beam, 18 feet; depth of hold, 7½ feet.

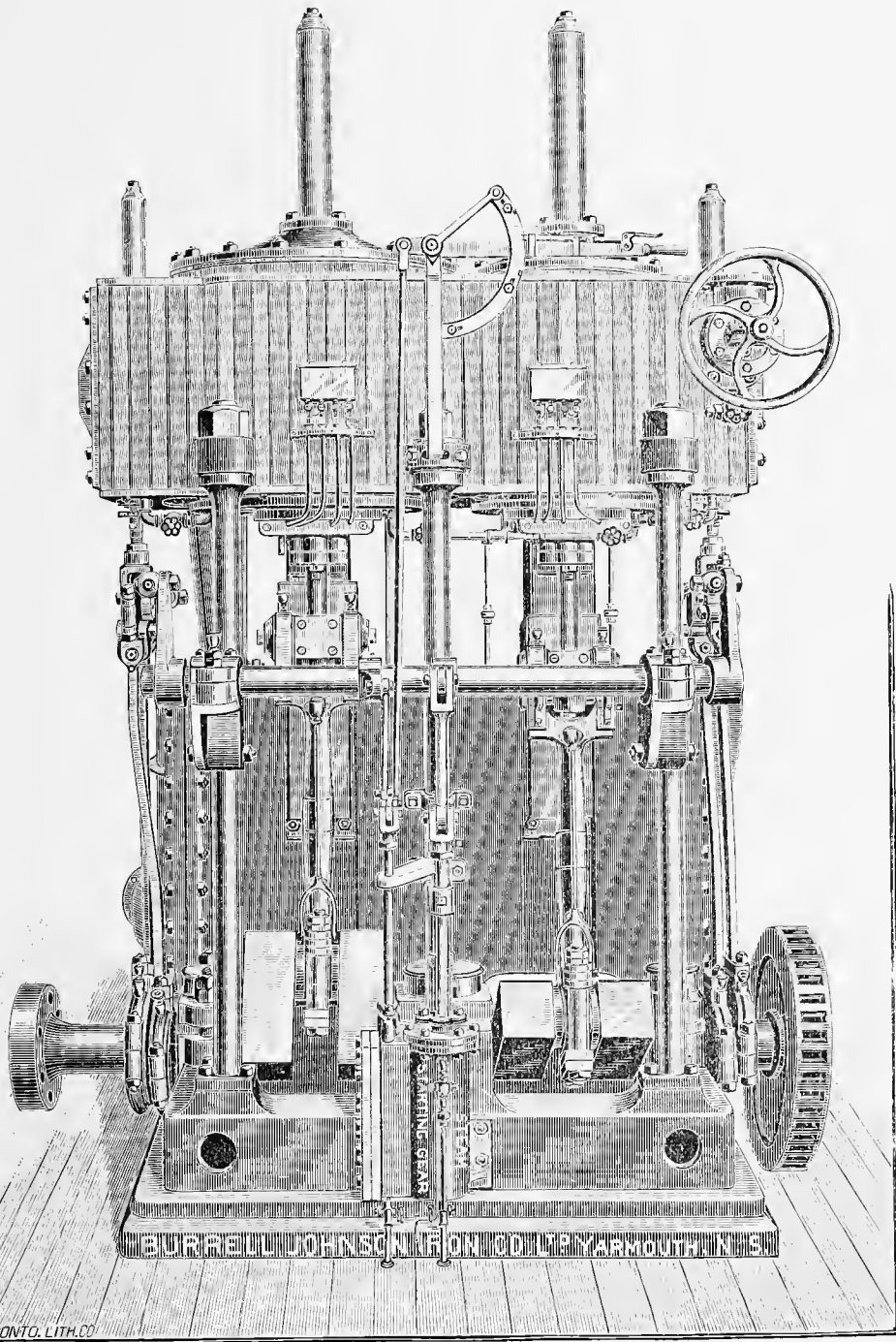

TANDEM COMPOUND SURFACE CONDENSING ENGINE OF THE STEAMER WEYMOUTH.

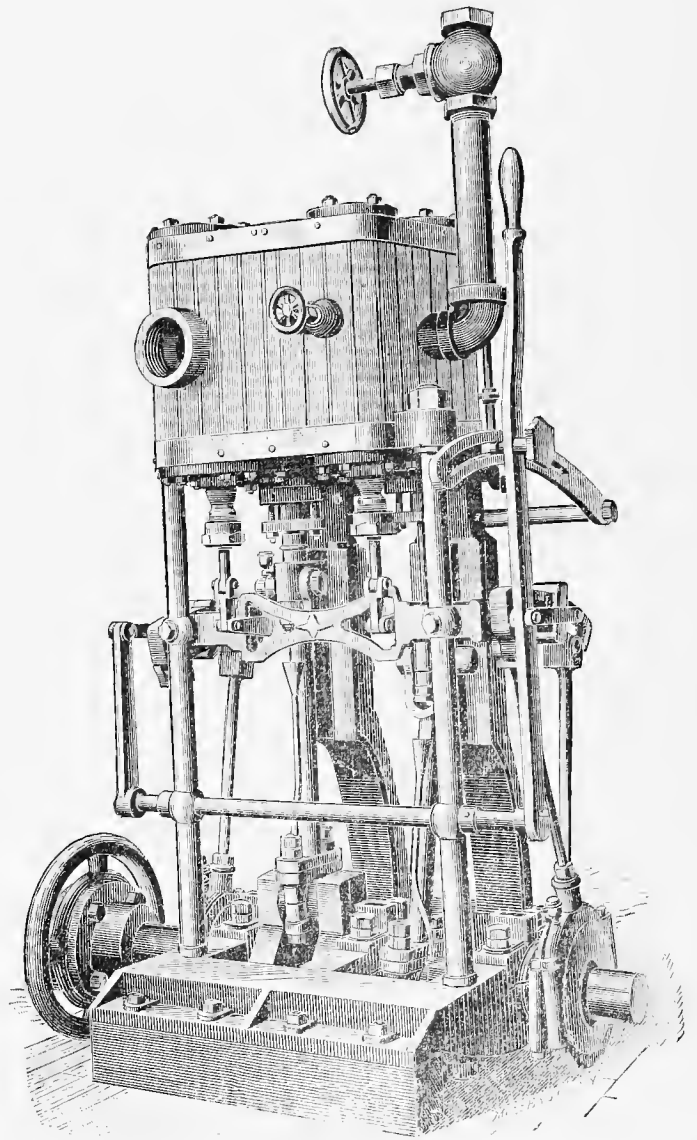

TROMBLEY'S COMPOUND YACHT ENGINE.

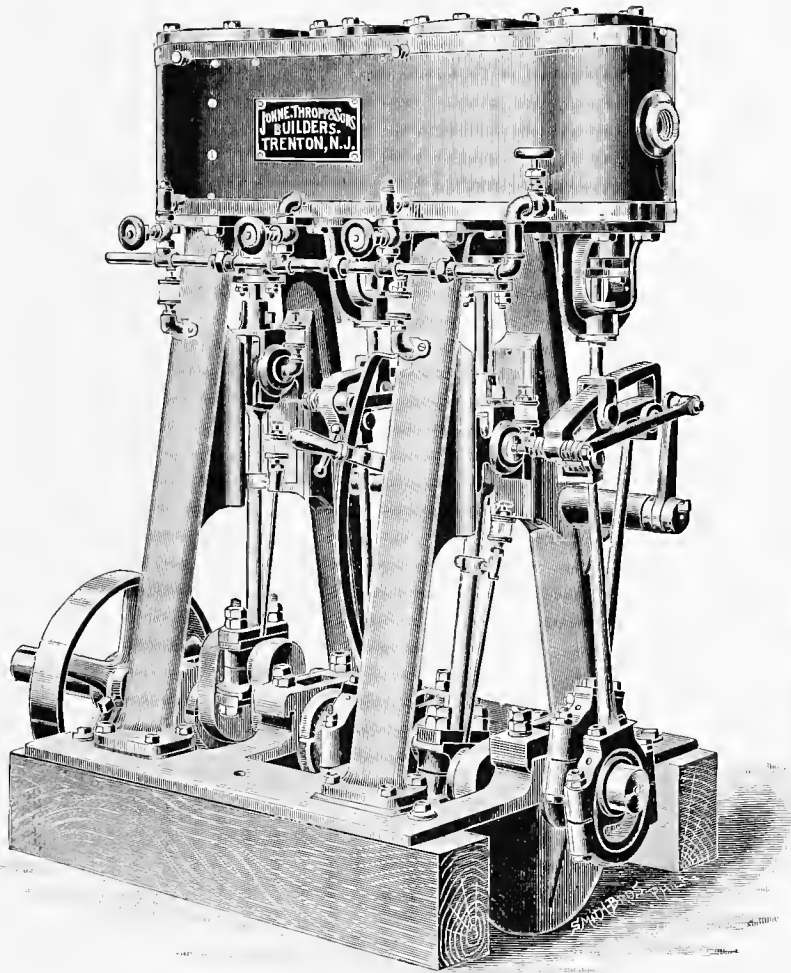

THROPP'S COMPOUND MARINE ENGINE.—Built by John E. Thropp & Sons.

Thropp's Compound Marine Engine.

A brief description of this engine is as follows: The cylinders are supported upon hollow cast-iron housings, which are securely fastened to a substantial bedplate. The latter is constructed so as to catch all the waste oil, and overcomes the saturation of hull with grease. The housings are bored in the lathe, also bedplate after being babbitted, making the engine machine-lined. All castings are made of the best charcoal iron, hard, close and free from sand holes. The valves are of the balanced piston type, which overcomes the serious objection often encountered in high-speed engines, and saves the wear and tear on the link motion and eccentrics. For reversing, the link motion made of steel, fitted with case-hardened block and pin, is used. The crossheads are made of steel, fitted with brass gibs. The crank shaft is large diameter, made of steel, with large crank pins, which insure a smooth working engine. Connecting-rods, eccentric-rods, piston-rods and valve stems are made of steel. The valve stem guide is fitted up with brasses, which are adjustable. All wearing parts are built so as to take up all lost motion. The builders of this engine are the John E. Thropp & Sons Company, of Trenton, N. J.

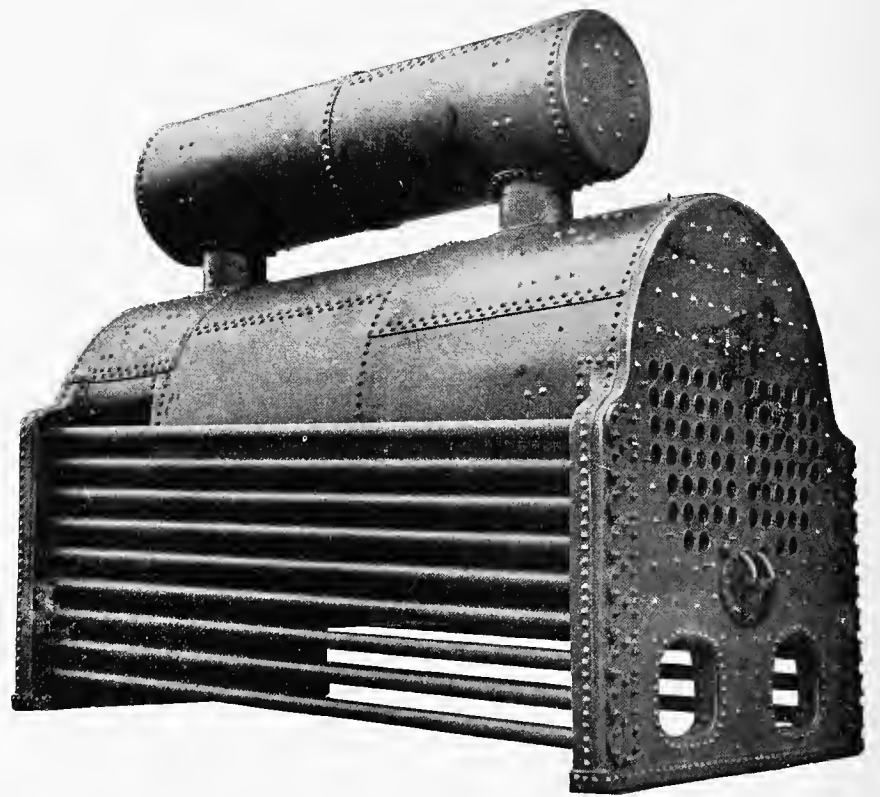

SLOAT'S FIRE AND WATER-TUBE BOILER.

Sloat's Fire and Water-Tube Boiler.

George V. Sloat, of Rutherford, N. J., superintending engineer of the Old Dominion Steamship Company, New York, has patented a fire and water-tube boiler, which is shown in the engraving. An engineer will understand it by inspection; but little explanation is needed. The ordinary return tubular boiler is provided with water table extending front and rear, which are connected with each other by water tubes upon the side, and a curved water leg, so to call it, amidships of the furnace, taking into the under side of the shell. The action of this combination is to produce a much more rapid circulation and a free disengagement of steam, while the heating surface for a given number of cubic feet occupied by the boiler is greatly increased. It is a wholly self-contained boiler for either land or marine purposes, and for the first mentioned duty is highly desirable, from the fact that it needs no brickwork or setting of any kind, the only external casing being a course of fire-brick over the water tubes, from water table to water table, front and back, as shown in section. This brick course is covered outside with sheet iron, which makes a handsome finish. Inclined side

tubes connect the front and rear water spaces, the circulation being front to rear in the side tubes, and from the base of the rear water space into the base of the main boiler shell near its rear end through a large curved connecting tube. The flame, in its passage rearward, strikes this connecting tube, and heats the water in it, thereby causing it to rise into the main body of the boiler, while the cold water flows from the base of the rear water space into the tube, thus maintaining a continuous circulation. The ends of the side tubes come opposite hand-hole covers, there being one cover for each two tubes. The engraving is merely a sketch, so to speak, showing no working details, but all facilities are provided for a thorough examination and access to the interior for cleaning and repairs. Mr. Sloat is a thoroughly practical engineer and knows what is needed for commercial work. One of these boilers has been in use for several years on the steamer Albemarle of the Old Dominion Line, and has given good results. It weighs only 20,000 pounds, and is 7 feet front and 14 feet long. It took the place of a lobster-back boiler weighing 30,000 pounds, 8 feet 6 inches front by 20 feet long, requiring twice the water that the present boiler does.

The Tromblee Compound Yacht Engine.

The Cedar Point Foundry Co., Port Henry, Essex County, N. Y., are the builders of this engine. The cut shows a $4\frac{1}{2}$ and 8 by 7 inches compound engine. Some of the dimensions are as follows: Bedplate, fore-and-aft, 19 inches; on bearing line, 20 inches; athwartships, 24 inches. Bottom of bedplate to centre of crank shaft, $3\frac{3}{4}$ inches; centre of crank shaft to top of engine, 3 feet $3\frac{1}{2}$ inches; face of coupling to centre of bedplate, 20 inches; diameter of crank shaft, 2 inches; steam pipe, $1\frac{1}{2}$ inches; exhaust, $2\frac{1}{2}$ inches. The cylinders and valve cases are all contained in one casting thereby avoiding joints. Piston valves are used for both cylinders, driven by link motion. The cylinders are mounted on cast-iron columns at the back and turned steel columns at the front. The crank shaft is made from a steel forging and is perfectly balanced. The crosshead is phosphor-bronze, the adjustments for wear being made by a sliding wedge worked by a screw. The eccentric is cast iron and the strap phosphor-bronze. Weight of engine complete about 775 pounds. These engines are designed by Andrew and Theodore Tromblee.

Compound Engine of Tug Edwin H. Mead.

The above named tug was built in 1893 by T. S. Marvel & Co., Newburg, N. Y., for the Cornell Steamboat Co., Rondout, N. Y. The engine was designed by Joseph De Rycke, New York. The cylinders are 22 and 44 inches in diameter by 32 inches stroke, and are fitted with automatic relief valves. The cylinder has a removable valve seat, and the valve is single-ported, and provided with independent adjustable cut-off valves.

The valve is double-ported, and has a balancing cylinder to relieve the weight. The engine has double-bar link motion, and a steam reversing gear. The crosshead guides are removable, and provided with water channels. The crossheads are forged and the slides fitted with antifriction metal bolted to them. The crank and propeller shafts are 9 inches in diameter; the main bearings are of cast iron, with antifriction metal; the

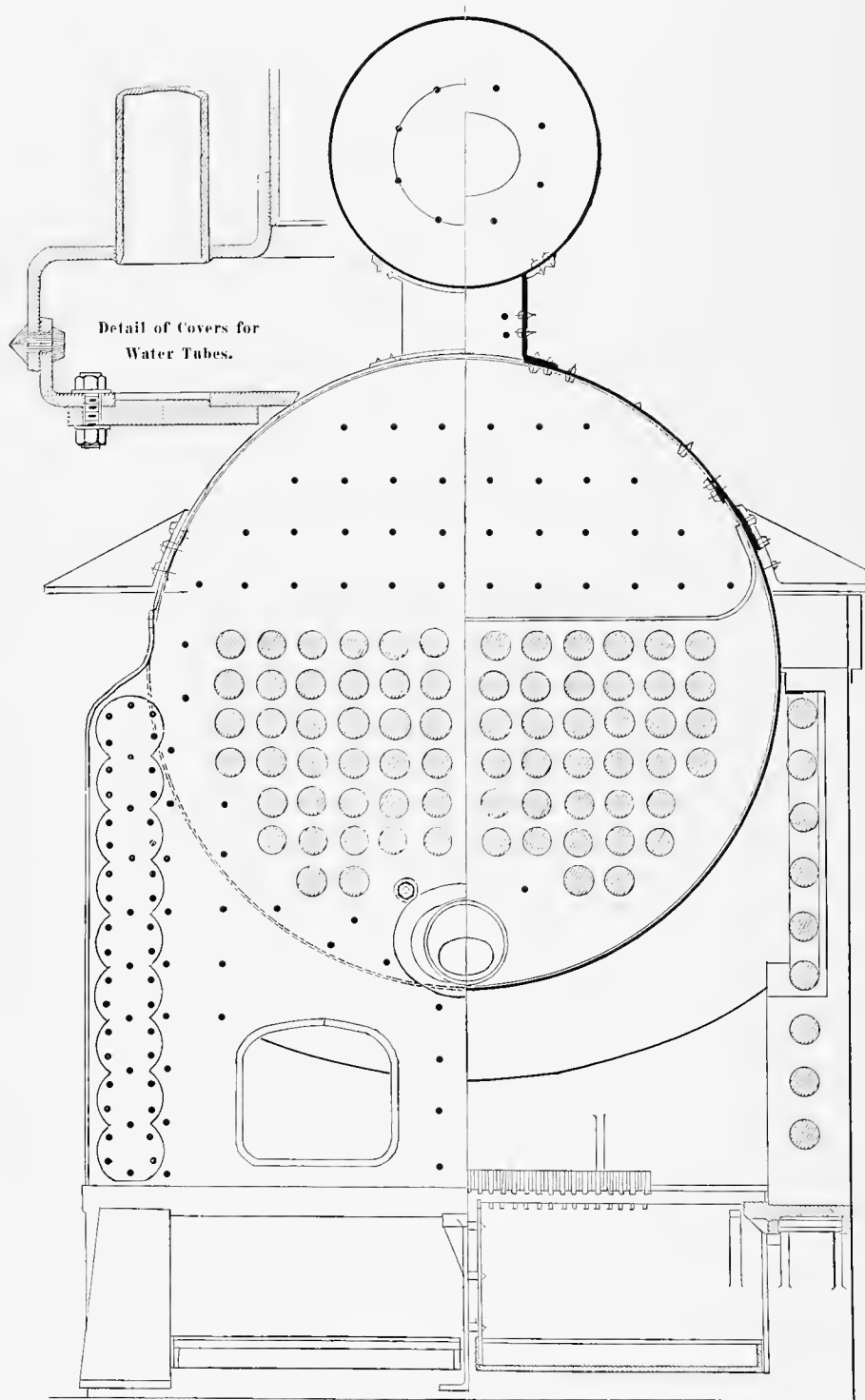

SLOAT'S FIRE AND WATER-TUBE BOILER.

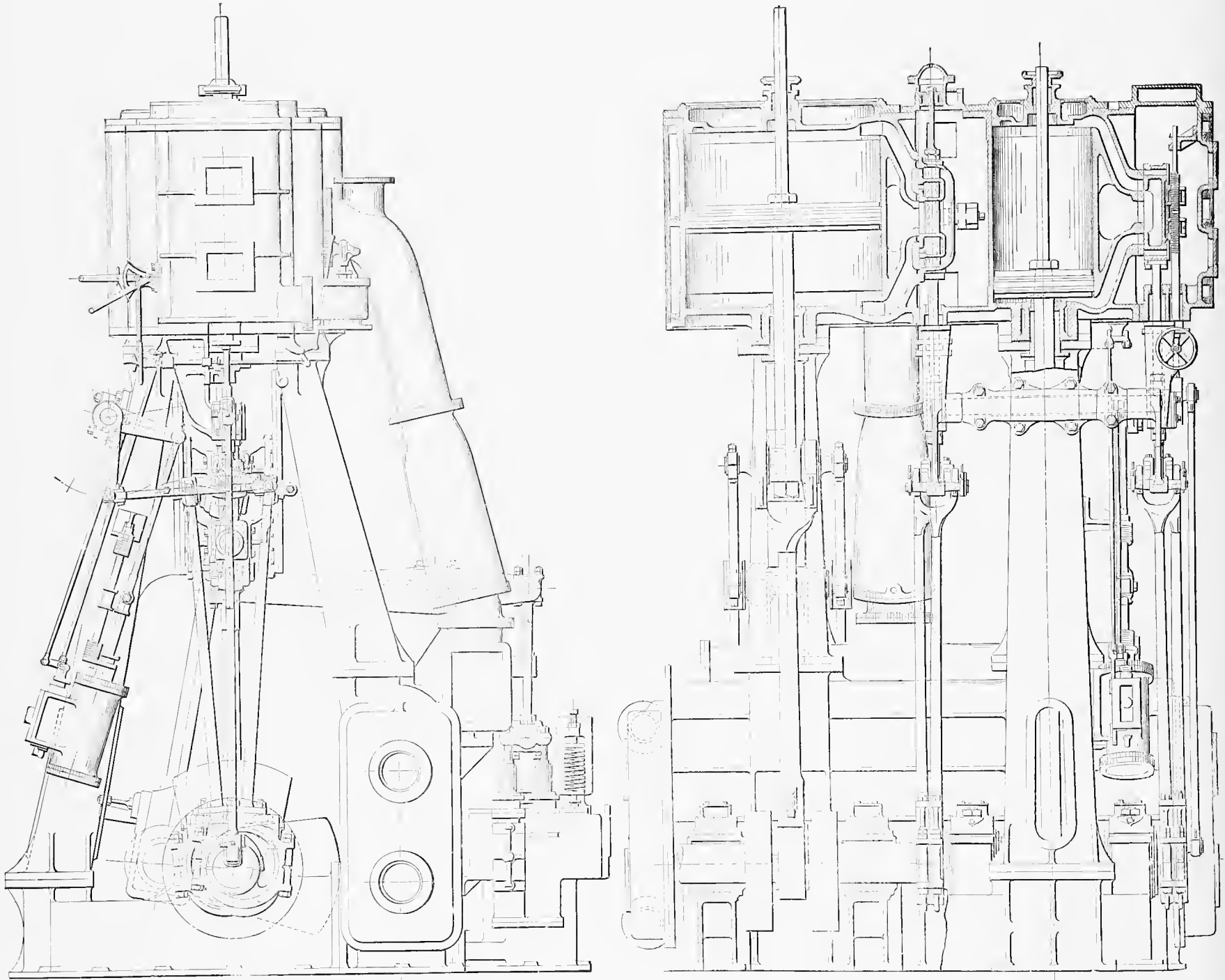

COMPOUND ENGINE OF TUG EDWIN H. MEAD.—Built by T. S. Marvel & Co., Newburgh, N. Y., for the Cornell Steamboat Co., Rondout, N. Y.

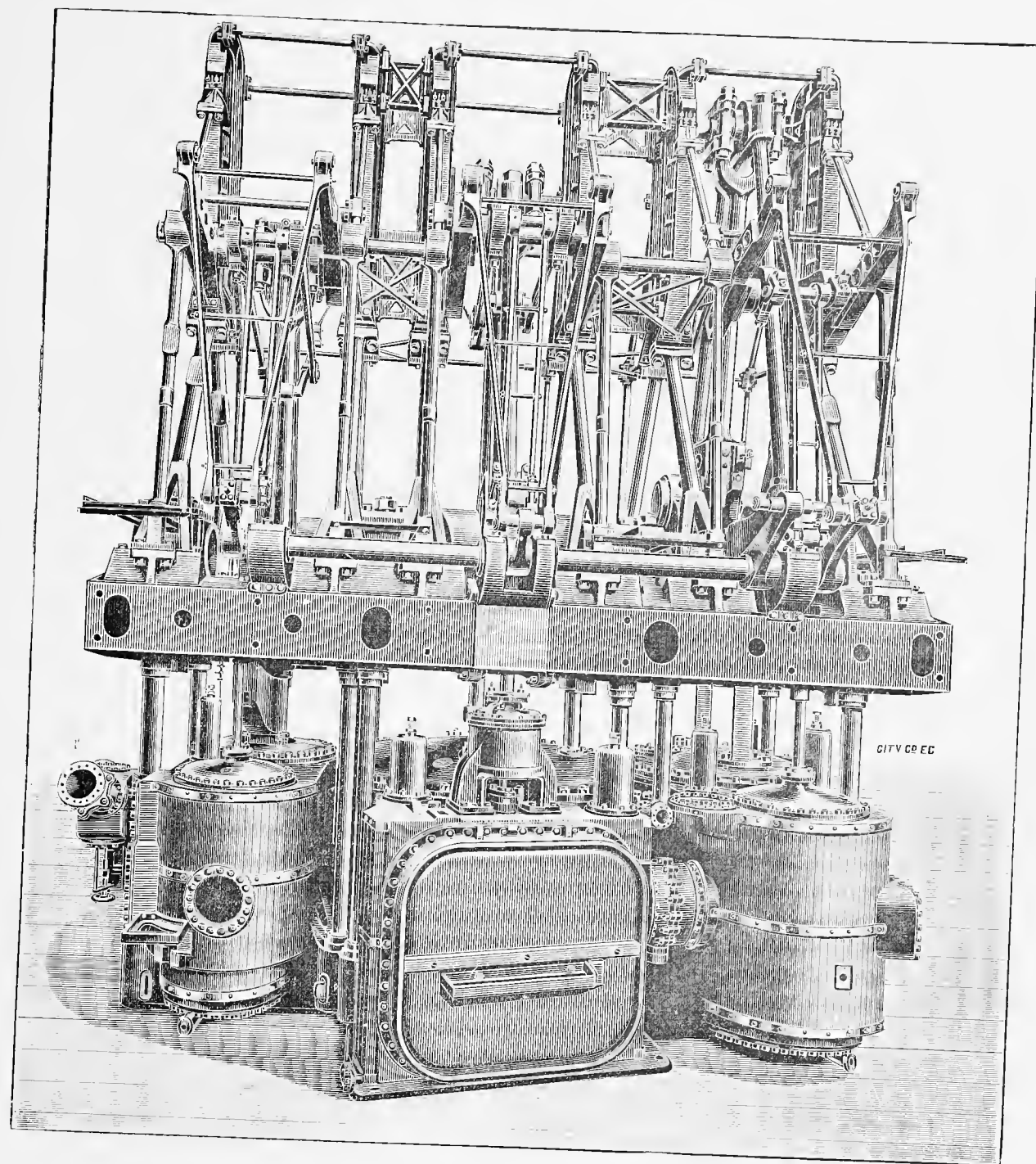

TRIPLE-EXPANSION STEEPLE ENGINES OF THE STEAMER BANSHEE.—Built by Laird Bros.

cranks are forged, and the crank pins are of steel, 9 inches in diameter. The thrust shaft has four collars, with removable horseshoe thrusts. The propeller is four-bladed, 9 feet 8 inches by 14 feet 6 inches pitch. There are two steel boilers, 11 feet 6 inches diameter by 11 feet long with two corrugated furnaces in each, $42\frac{1}{2}$ inches diameter; the working pressure is 110 pounds. There is a superheater 8 feet in diameter, 5 feet 9 inches high, having an internal corrugated flue $52\frac{1}{2}$ inches diameter. There is an auxiliary boiler, 3 feet in diameter by 6 feet high. The throttle valve is a balanced piston; and the exhaust from the low pressure passes through a Straight Line centrifugal grease-extractor and a feed-water heater on its way to the condenser. The latter has a cooling surface of 1,125 square feet. The tube heads are of brass, provided with stuffing boxes, which are packed with corset lacing, and held in place by screw glands. The air-pump is 18 inches in diameter by 14 inches stroke. There is one bilge-pump and two feed-pumps, the latter being $3\frac{1}{2}$ inches in diameter each, and provided with automatic safety relief valves; all worked by wrought-iron beams connected to the low-pressure crosshead. The vessel is of steel, 122 feet long by 25 feet beam, and has a draught of 11 feet 9 inches. She has a speed of 15 miles per hour, the engines making 115 revolutions per minute, with 110 pounds boiler pressure, 12 pounds receiver pressure, and 27 inches vacuum. This vessel has towed 18 square-ended scows from 110 to 120 feet long, with an average load of 500 tons, making

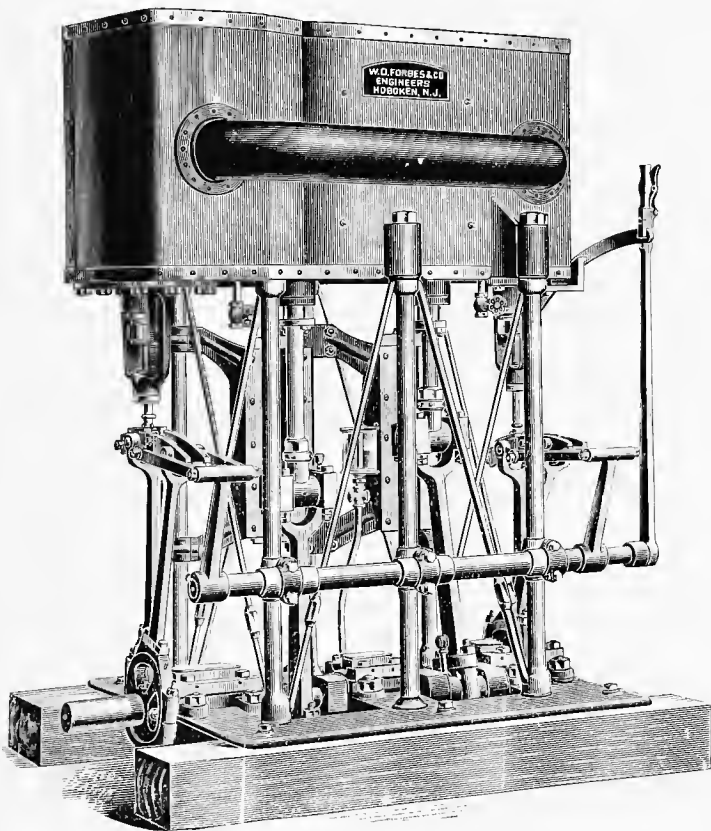

FORBES' VERTICAL YACHT ENGINE.—By W. D. Forbes & Co.

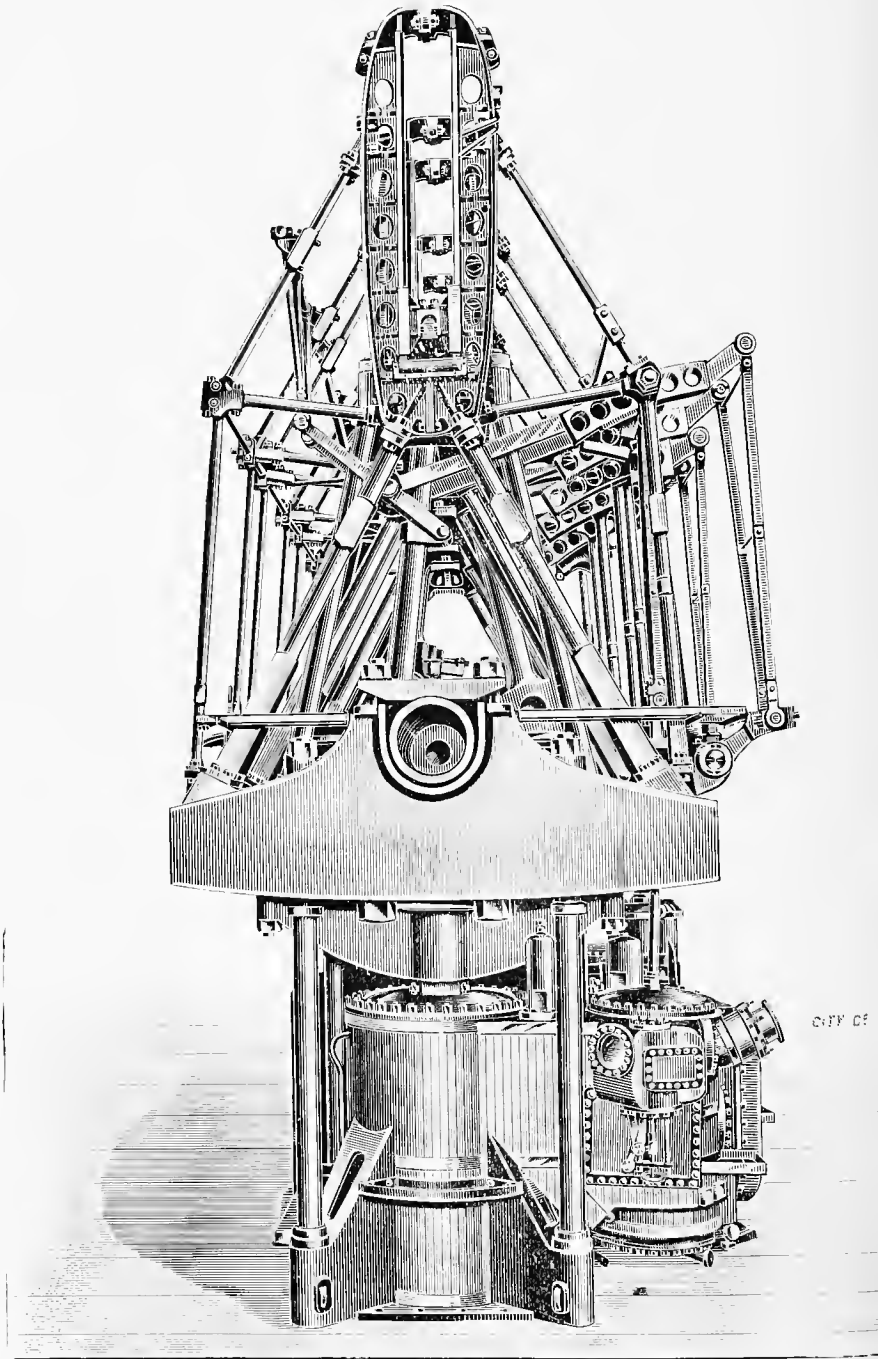

STEEPLE ENGINES OF THE HOLYHEAD & DUBLIN MAIL STEAMER BANSHER.

a total load of 9,000 tons, at the rate of $3\frac{1}{2}$ miles per hour, slack water, and has towed 42 empty scows at the rate of 7 miles per hour. She is one of 40 tugs owned by the Cornell Company.

The Banshee's Steeple Engines.

The London and North Western Railroad Co.'s express paddle steamer *Banshee* was fitted in 1894 by Laird Bros., Birkenhead, England, with new machinery on the tri-compound system, after the pattern of that made by the same firm for her sister boats, *Lily* and *Violet*, several years ago. On her trial trip from Holyhead to Kish Light the run occupied 2 hours 21 minutes, the engines making 36 revolutions with 4,750 indicated horse-power, the return run against the tide with a rough beam sea and southerly breeze occupied exactly the same time with 38 revolutions and 5,150 indicated horse-power, the speed for the whole time being 20.42 knots. There is remarkably little vibration, and the vessel is extremely handy. The machinery consists of a set of triple-expansion steeple engines. The cylinders are bolted, without the intervention of any bed-plate to the engine-room keelsons, by ordinary holding down bolts, and secured to the entablature above by wrought-iron columns. The cylinders are placed in line athwartships, the low-pressure being in the middle, the high-pressure on the port side, and the medium-pressure on the starboard side. The pistons and piston-rods, the bowstring crosshead pieces, and the connecting-rods, as well as other parts, are of steel. Owing to the small athwartships space in which it was necessary to place the three cranks, the valve chests are placed on the aft side and eccentric motion dispensed with. The type of valve gear adopted is Joy's, which is well known as possessing the good point of occupying little room. Piston valves are used for the high-pressure and medium-pressure engines, and a balanced D-slide for the low-pressure engine. The reversing gear is attached to the upper framing which supports the guides, and is worked by a steam and hydraulic engine. The crank pins, crank shafting, and paddle shafting are of hollow steel. All the bearings have a very large wearing surface. The condenser is placed in the fore part of the engine-room. The circulating water is supplied to it by a 16½-inch centrifugal pump driven by a compound engine. The air-pumps are of a special design. There is a vertical triple-expansion engine placed immediately over the three air-pump cylinders, each steam cylinder and pump cylinder being in line, the crank shaft being placed between. The main feed-pump is separate, and there are also auxiliary steam feed-pumps, bilge and fire-pumps. Steam is generated in six boilers of the locomotive marine type, at a pressure of 155 pounds to the square inch. They are placed in two groups of three each, in two closed stokeholds. Air is supplied to the furnaces by two large fans, situated on the upper deck, driven by two sets of compound vertical engines. The air pressure is ¾ inch of water. The paddle-wheels are fitted with curved steel floats of special design.

The dimensions of the new engines are as follows: Cylinders, 44, 70 and 108 inches by 78 inches stroke. The old engines were of the oscillating type, with two cylinders 80 inches in diameter, 84 inches stroke. The *Banshee's* dimensions are: Length, between perpendiculars, 310 feet; beam, 34 feet; depth of hold, 14 feet 2 inches, and she has a gross register tonnage of 1,249 tons. Her working draught is about 11 feet 3 inches. The *Banshee* runs between Holyhead, Wales, and Dublin, Ireland, carrying passengers and the mail.

The Forbes Yacht Engine.

An unusual compound engine, built by W. D. Forbes & Co., of 1304 Hudson Street, Hoboken, New Jersey, is shown in the cut. This engine contains no new principles, its claim to note being based on constructive details. The usual heavy staunchions are eliminated, two-inch bars of machine steel being substituted. These are braced diagonally by tension rods provided with a turn buckle for increasing the stress, as plainly shown. This gives the engine a very neat and light appearance combined with the requisite strength. The usual round section connecting-rod is dispensed with, the stuffing boxes are unusually long, the guides are a departure from the usual types and are furnished with adjustable bronze shoes. The bearings are large and preclude all possibility of heating or excessive wear. It is a high-speed engine, running at 450 revolutions, and develops from 125 to 150 horse-power, the cylinders being 8 by 16, and the stroke 10 inches. The floor space is very small for an engine of this power, being 44 by 36 inches, while the height is 74 inches, thus making it especially desirable where a small space only can be devoted to power. Messrs. Forbes & Company have installed these engines in several 70-foot launches with great success.—*Power*, New York.

Hayes' Compound Marine Engine.

The cut represents one of the sizes of Hayes' compound surface-condensing engines suited for tugs, yachts or launches. These engines are designed and built by Edward Hayes, Stony Stratford, Buckshire, Wolverton, England. The engine shown is intended for the severest description of work in towing, and for heavy steam launches where considerable power in running is necessary. The surface condenser is fitted with brass tubes and tube plates, the tube ends being secured by screw glands with cotton washer packing. The slide valves, steam ports, passages, and the chamber of cylinder, have proved themselves to be of the best proportions. This type of engine was placed in the steam yacht *Regalia*, which, it will be remembered, won the international steam yacht race on the Paris course at Argenteuil, in June, 1889.

The Smit Marine Engine.

This triple-expansion engine was designed and built by P. Smit, Jr., of Rotterdam, Holland, and is of 130 horse-power. The high-pressure cylinder has a diameter of 8 inches, the intermediate cylinder of 12 inches, the low-pressure of 20 inches, all with the same stroke of 14 inches. The diameters are calculated for a boiler pressure of 150 pounds. According to the diagrams, the power is nearly equally divided. With 185 revolutions per minute, the high-pressure cylinder gave out 45.4 indicated horse-power; intermediate, 42 indicated horse-power; and the low-pressure, 44.35 indicated horse-power, or a total of 131.75 indicated horse-power. These engines consume but a little quantity of coal, as on the trial trip it only amounted to 34 kilograms, or nearly 0.64 kilogram per indicated horse-power, which is very low for so small an engine. The novelty of these engines is the movement of the slide valves which, simple in

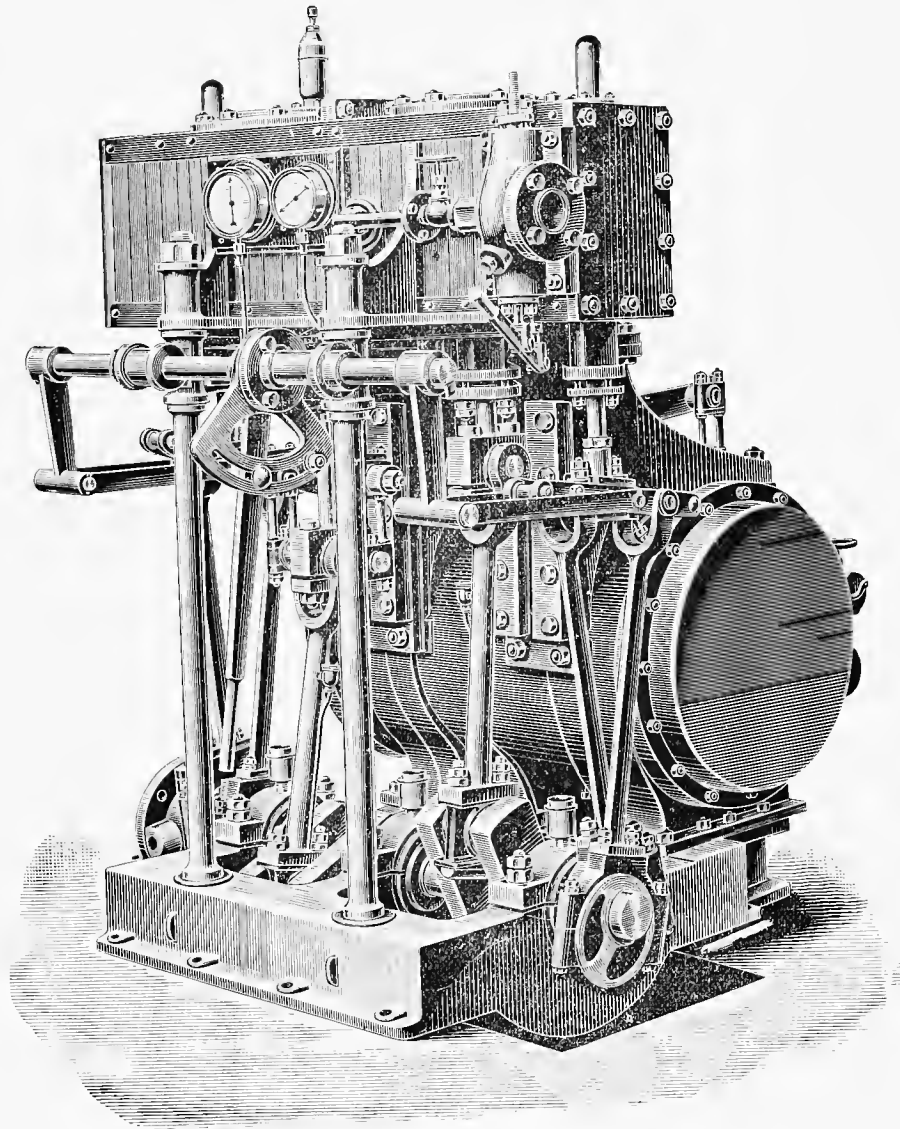

THE HAYES COMPOUND MARINE ENGINE.

itself, gives a very compact engine, as the cylinders may be as close together as is consistent with the combination of the cylinders through flanges bolted to each other. The slide valves are moved by a common eccentric, which is cast on a sleeve of cast steel, in which is turned a hole, through which the inner shaft runs. This shaft is rotated by two cranks or pins fastened to the outer flanges, which get their rotation from eccentrics keyed to the crank shaft of the engine. The engine is reversed by backing the handle, which is placed on a casting on the foundation. This lever moves the cast-steel sleeve in the usual way, which turns the eccentrics of the slide valves to the opposite angle and reverses the engine.

These engines are made in all sizes up to 1000 indicated horse-power. The larger ones are fitted with steam reversing

gear, and may be made with link motion without altering the system. The cylinders are coated with non-conducting material over which cast-iron mantles are fitted to form a neat and solid appearance.

The Seabury Triple-Expansion Yacht Engine.

Chas. L. Seabury & Co., Nyack, N. Y., have been careful in designing a triple-expansion engine to combine all the best qualities of that class of engine; also to reduce its weight to the minimum, yet having necessary strength. They are accurately proportioned to give equal power from each cylinder, great care being taken to have no superfluous metal in the revolving

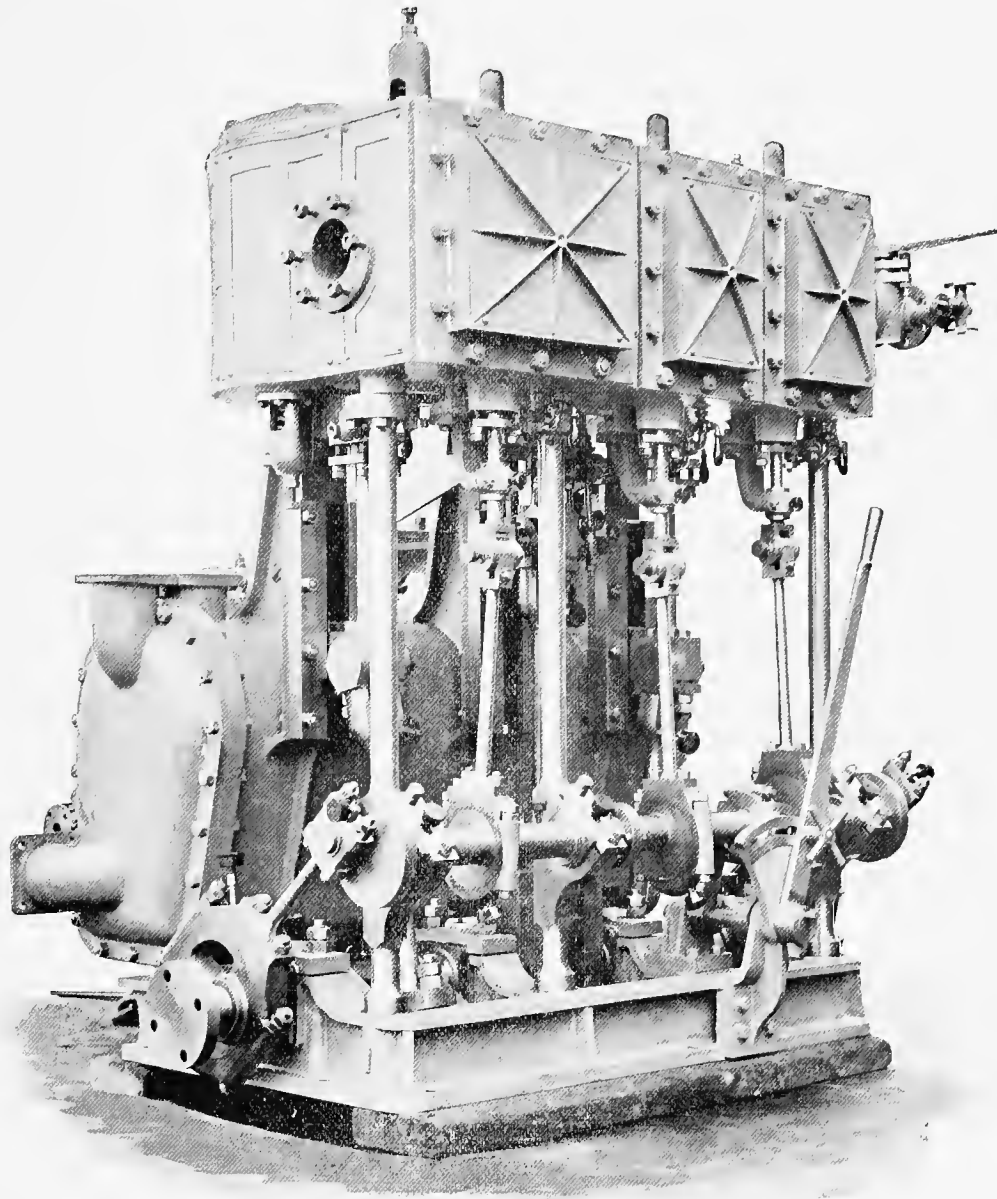

TRIPLE-EXPANSION ENGINE.—Designed and Built by P. Smit, Jr., Rotterdam.

parts, allowing a large factor for safety; therefore a high rotative speed can be had with very little noise or vibration. The bedplate is of close-grained cast iron, of the best design, and strongly webbed throughout. The main bearings are lined with the very best Babbitt metal, scraped to crank shaft. Crank shaft, valve shaft, stanchions, valve rods, piston-rods, braces, rails and levers are made from solid steel stock of best quality. Connecting-rods and eccentric-rods are forged from solid steel without welds. All are finished bright and polished.

The crank pin boxes are of best bronze, lined with Babbitt metal. Crossheads are of bronze running in cast-iron slides; all

bearings and wearing surfaces are made extra large, as they are built for heavy and continuous work; bearings are also arranged for taking up all wear. All main bearings, crank pin bearings and crosshead pin bearing bolts are provided with a simple arrangement for preventing slacking off when running. The thrust bearing is made by turning collars on crank shaft running in Babbitt-lined grooves in bedplate. Air-pump is made of bronze and is operated from low-pressure cylinder. The cylinders are made of the best fine-grained cast iron, bored true and fitted with steel pistons and cast-iron rings; bushings are also fitted for piston valves which are used, as greater ac-

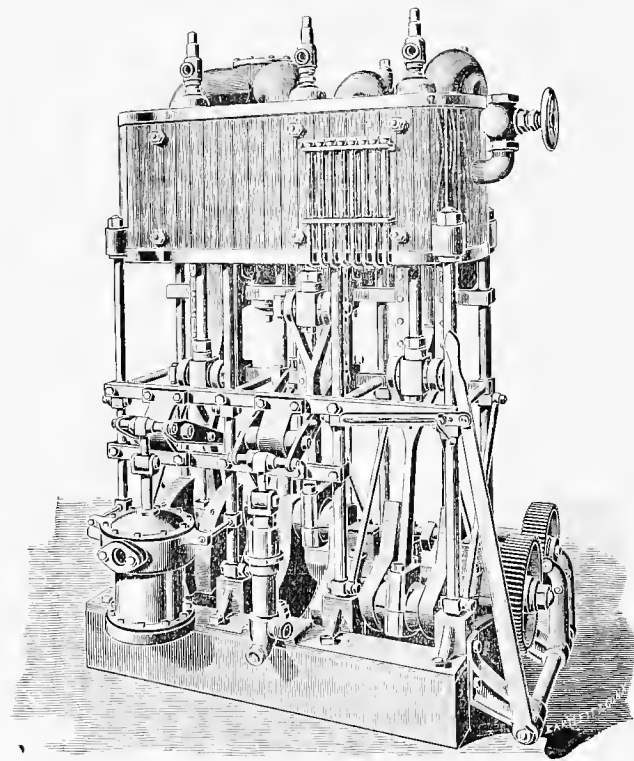
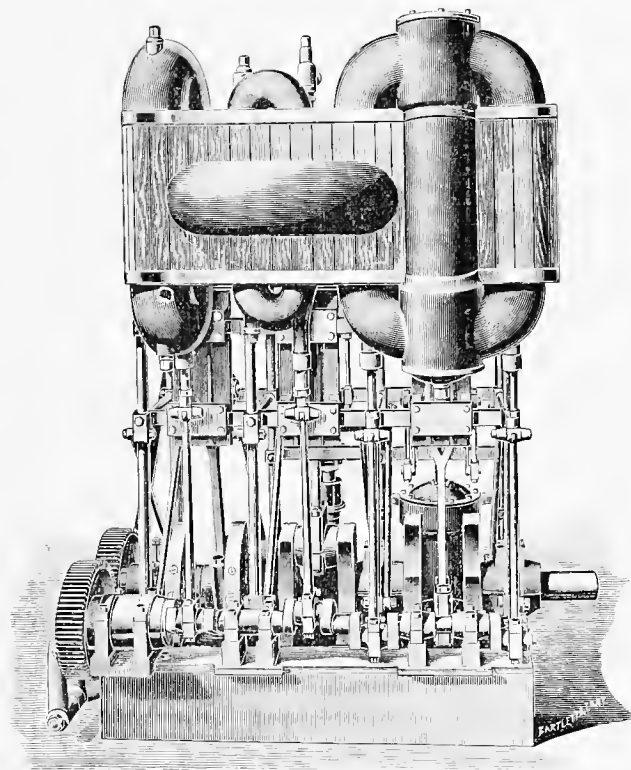

THE SEABURY TRIPLE-EXPANSION YACHT ENGINE.

curacy is obtained at the steam ports than where valves are fitted to cylinders without bushings. Relief valves and drip pipes are fitted to each end of all cylinders. The engines are neatly jacketed in brass and mahogany. Two hundred and twenty to 240 pounds of steam should be carried to get economical results, although they have numbers of them running with 275 pounds.

They also build compound and simple engines for marine work. Have built a large number for blower and electric light purposes, some of these having run 2,000 revolutions per minute.

The Wheeler Surface Condenser.

The "Wheeler-Admiralty" surface condenser differs from the "Wheeler-Standard" in that it has single instead of double tubes. These tubes, however, are arranged in a special manner, thereby securing minimum number of joints liable to leak, with ample provision for expansion and contraction. As shown by sectional cut above, one end of the tube is drawn thick enough to chase upon it deep screw threads, and has a slot for a screw driving tool. The other end of the tube is packed with corset lace packing, secured by a screw gland also having a slot for screw driver tool; the tube can move freely at this end while the other end is held firmly in the tube head.

Where customers prefer the ordinary arrangement of screw glands at both ends of the tubes, packed with the usual

corset lace packing and secured with patent screw glands, the manufacturers can always accommodate them, as their regular pattern of "Wheeler-Admiralty" surface condenser is so arranged.

The Wheeler patent surface condenser known as the "Wheeler-Standard," and which has been in successful use for years, is the result of extensive and wide experience in this special line. It combines the necessary theoretical qualifications with thoroughly practical features. Briefly stated, Wheeler's improved surface condenser possesses the following advantages, *viz.*

First.—The tubes are so arranged that they are free to expand and contract without the use of packings of paper, wood or similar materials; in fact, there are no ferrules, followers, washers or tube packings of any kind employed. Plain screw joints only are used—the simplest, most durable and efficient tube fastening possible, one that is always tight and cannot dry out or wear out.

Second.—The tubes are straight, of seamless drawn brass tubing, and carefully tinned inside and outside. They can be easily taken out and thoroughly cleaned in a few hours' time by unskilled labor. The inside tube head does not have to be removed from the condenser for the cleaning or repairing of the large tubes.

Third.—The exhaust steam, as it enters the condenser, finds ample room in which to expand, and is then uniformly distributed over the cooling surface. This, together with a very active and perfect circulation of condensing water in the tubes,

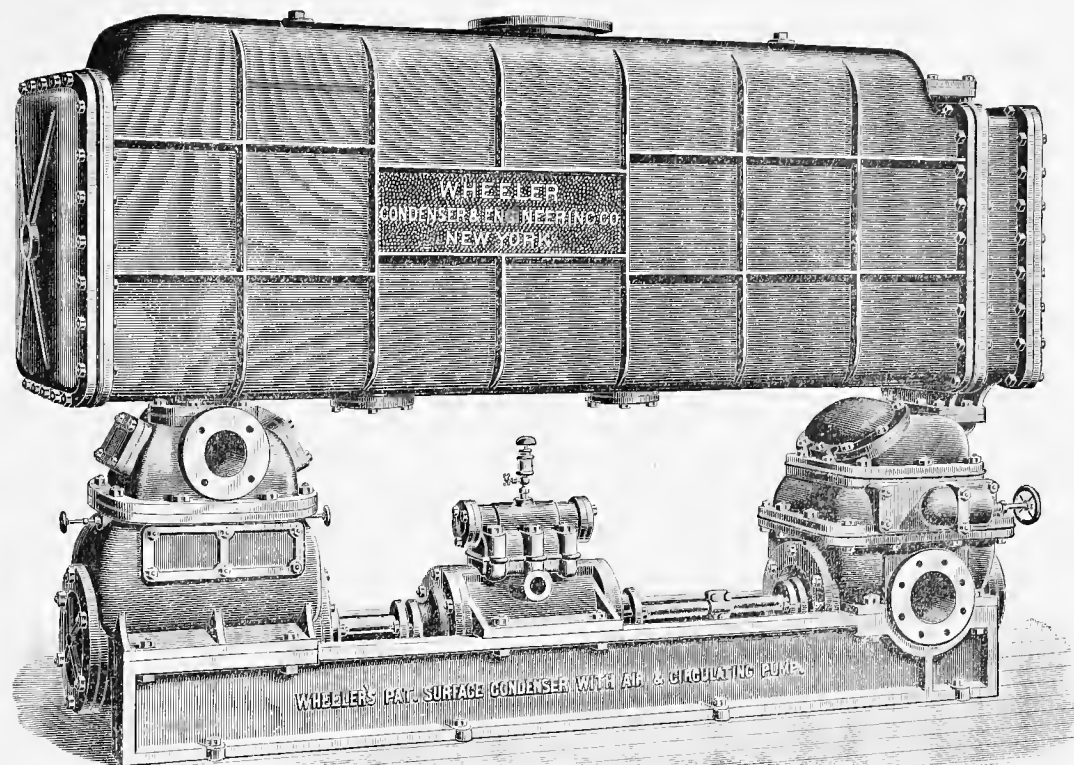

RECTANGULAR PATTERN OF THE WHEELER-ADMIRALTY SURFACE CONDENSER MOUNTED UPON COMBINED AIR AND CIRCULATING-PUMPS.

produces a more uniform temperature in the condenser, making one portion as efficient as another, and economizing the amount of cooling surface and circulating water.

The Wheeler light-weight surface condenser is applied to small steam vessels, where the minimum of weight and space are combined with simplicity and greatest efficiency.

These improved condensers are made in the smaller sizes, with shells of brass or hammered copper. The tubes are of seamless brass, well tinned inside and outside, and are drawn with great care. These tubes are screwed into the tube heads, thus making tight and durable joints, a very important feature for condensers that are out of use a large part of the year, as in the case of steam yachts, etc. There are no ferrules, washers, tube packings, etc., to leak or dry out.

These condensers combine minimum weight with maximum efficiency; they are more satisfactory and quite as inexpensive as keel (outboard pipe) condensers, and will give the hot feed-water—an impossibility with the latter form of condenser.

The substitution of a Wheeler light-weight surface condenser for the keel condenser also removes a great impediment to the speed of a boat. The keel condenser not only gives chilled feed-water and unsteady vacuum, but is always a source of trouble and liable to damage from collision with floating matter or by the boat running aground.

For launches, steam yachts and light-draught steam vessels plying in fresh water, the Wheeler light-weight jet condenser is the simplest and most compact condenser in the market. In weight it is remarkably light—an important consideration. It

can be attached to a connected air-pump and worked by the main engine, or it can be arranged with an independent air-pump. The latter is a better plan, as vacuum can be formed for the main engine before starting it, and being independent the speed of the pump can be regulated to suit the demands of the engine. With the high rate of speed that marine engines are now run at it is a great disadvantage to have connected air-pumps.

The Wheeler light-weight jet condenser is a shell of hammered copper or galvanized iron—the exhaust steam pipe, the injection pipe and the pipe that connects the condenser with the air-pump are all attached to the large head, which is a casting made exceedingly light and strong. The injection water is thoroughly distributed by means of a perforated spray pipe extending through the centre of the condenser. One end of this spray pipe is firmly attached to the small flange, on the outer side of which is a convenient handle (see left-hand end of condenser in cut); the other end of spray pipe fits over a nozzle cast on the inner side of the large head, and which projects into the condenser a short distance, thus forming a continuance of the injection pipe outside. When necessary to clean the spray pipe from dirt, chips or grass brought in by the injection water, all that is required is to unbolt the small flange and by means of the handle draw out the spray pipe. This convenient feature avoids disturbing any of the piping, and gives easy access to the interior of the condenser. The Wheeler Condenser and Engineering Company, New York, are the builders of these condensers.

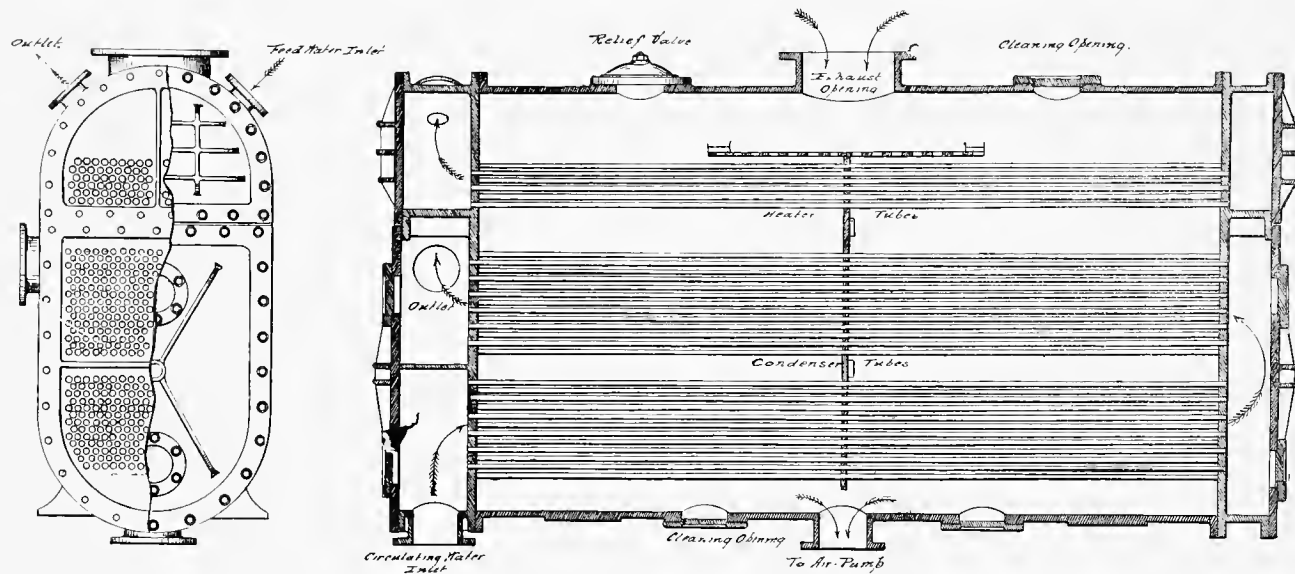

THE VOLZ PATENT COMBINED SURFACE CONDENSER AND FEED-WATER HEATER.

The Volz Patent Combined Surface Condenser and Feed-Water Heater.

Marine and stationary engineers using surface condensers are well aware of the difficulty of retaining the feed-water in the hot-well at or near the proper temperature due to the vacuum in condenser, particularly in cold weather. The water of condensation necessarily lowers its temperature as it passes from the condenser through the air-pump, and from thence to the hot-well, filter tank and through the feed-pump, as there is considerable radiation of heat from the pipes and other surfaces. As it is very desirable to return the feed-water to the boilers at as high a temperature as possible, thus not only economizing fuel but adding to the life of the boiler, the use of a simple and effective method of heating the feed-water is of great importance. The Volz patent combined surface condenser and feed-water heater fully meets this condition and is very simple in design. It adds but little extra cost and space, and a high vacuum can be maintained, irrespective of temperature of hot-well; it has given the most satisfactory results on board of steam vessels. The heater tubes are located in the upper part of the condenser, and therefore are exposed to the hottest steam. The feed-water is consequently heated to within a few degrees of the temperature of the exhaust steam. There is no "choking" of the exhaust steam through small and contracted passages as with ordinary heaters, and there is no unnecessary back pressure on the feed-pumps. A large amount of heating surface is obtained, whether the condenser is built either cylindrical or rectangular; furthermore, the weight and space saved over that required for the ordinary heater (sometimes crowded in exhaust pipe) is of considerable value. The engravings show a sectional view and end view (tubes partly exposed) of the patented combined surface condenser and feed-water heater, cylindrical type. The exhaust steam enters through the top opening in the usual way, passes over a scattering plate and then comes in contact first with the

heater tubes and then with the condenser tubes, where after condensation, it flows to the air-pump, which in turn delivers it to the hot-well tank. The feed-water is taken by the feed-pump from hot-well and delivered near the top of the upper or feed chamber, as shown by the arrows, then passes twice through the heater tubes and finally to boilers. The circulating water enters the water chamber at the lower nozzle, as shown, and after passing through the condensing tubes is discharged through the upper nozzle at the same end of the condenser. An automatic relief valve is placed on top of condenser, the vacuum always keeping it closed. The tubes of both heater and condenser are of seamless drawn brass, tinned on both sides, with ferrules at each end properly packed. The shell of condenser is usually cast iron. The water chambers and tube heads are made in one composition casting, with the division plates separating the feed from the circulating water cast in, thus avoiding joints. This feed chamber is made to withstand boiler pressure. Free access to the tubes is provided by the arrangement of separate bonnets or heads. The Wheeler Condenser and Engineering Co., New York, are the builders of the above device. The inventor and patentee is Wm. E. Volz.

Wells' Balanced Compound and Quadruple-Expansion Engine.

In order to balance all forces it must be a natural balance. This can only be accomplished by a double action, where equal steam pressures are exerted simultaneously on opposite cylinder heads, and where all forces are equally applied to opposite sides of the crank shaft moving in the same plane. Any deviation from the plane produces disturbing and destructive elements.

The Wells system represents the only improvement in principle that has ever been made. The important advantages derived from a balance of forces in the steam engine were practically unknown until demonstrated by this system, for the

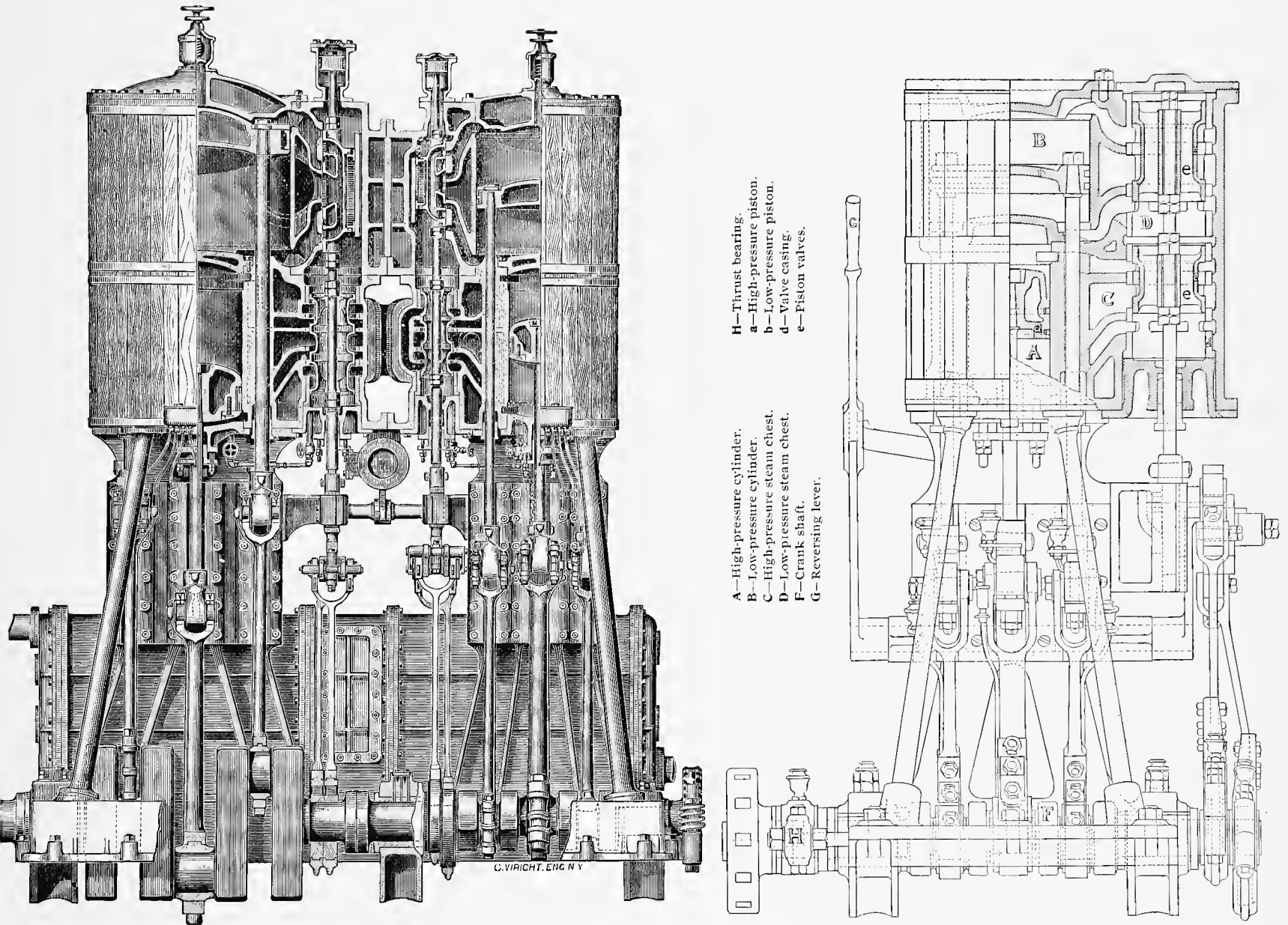

WELLS' PATENT QUADRUPLE-EXPANSION ENGINE.

reason that all engines constructed with a "balance" in view embraced grave mechanical objections. Hence, the single-acting "unbalanced" reciprocating engine is the only system that has proved to be of any value. While the Wells engine embraces all of the desirable features of the most approved type in general use, it contains none of its objections. It is double acting and so designed that all forces acting in the high-pressure cylinder are held in proper position by the forces acting in the low-pressure cylinder, producing a perfect balance around the crank shaft, and preventing vibration and the escape or loss of power that in all other engines is thrown off through the frame into the foundation.

BALANCED STEAM PRESSURES.

We desire to call especial attention to this important feature (not contained in any other engine), as it would be impossible to obtain a balance without it.

Steam is admitted to both cylinders simultaneously; during the first stroke, the steam pressures upon the middle cylinder head are exerted against each other; the force acting upward in the high-pressure cylinder becomes the support of the force acting downward in the low-pressure cylinder. In the return stroke the pressures are exerted upon the top and bottom cylinder heads in opposite directions, giving a balance of pressures within the cylinders—a condition that applies to no other type

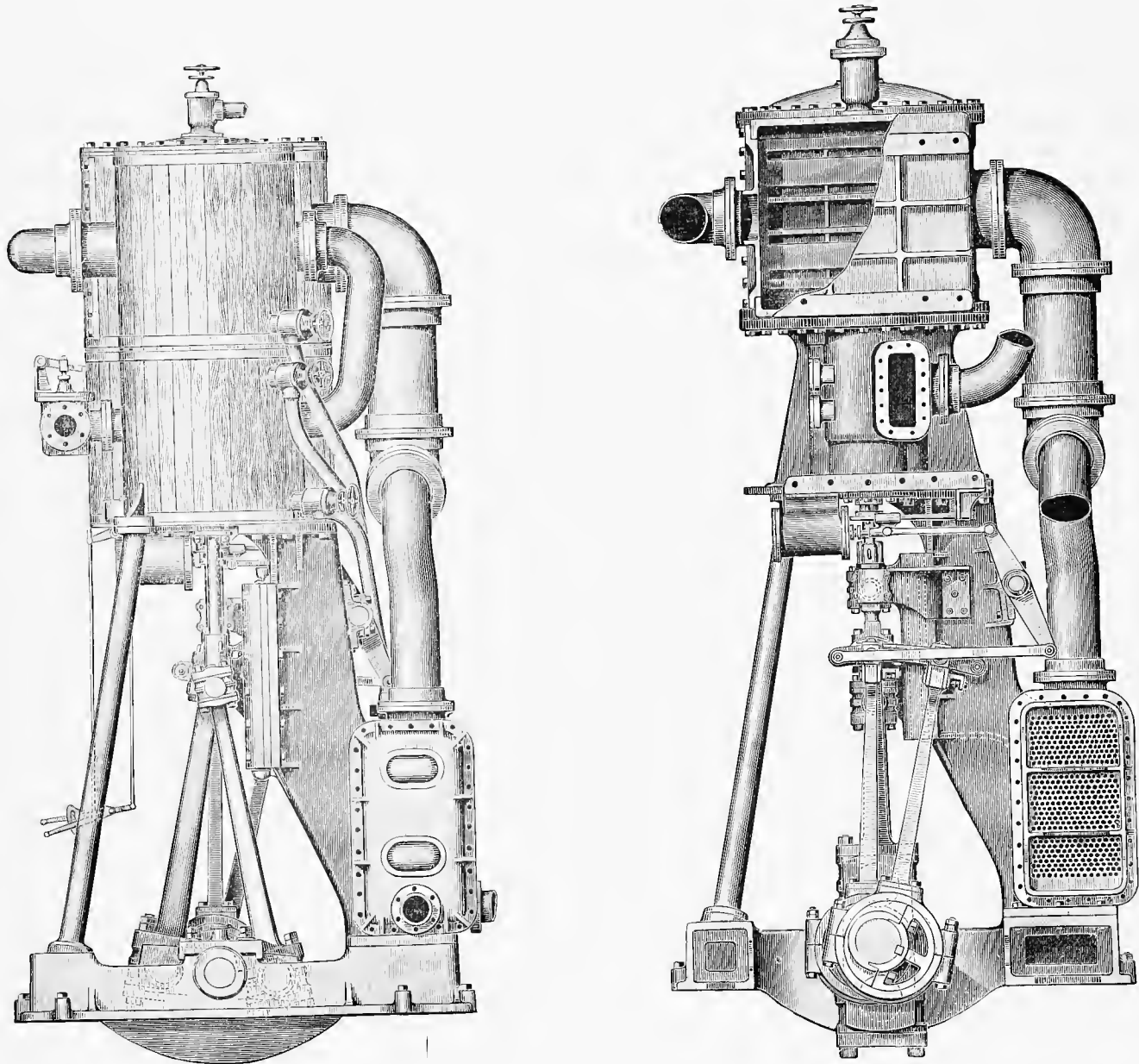

WELLS' PATENT BALANCED ENGINE.

of engine, as no strains are communicated to the frame and bedplate.

BALANCED FORCES AND MOTIONS.

The force of the steam applied to the high-pressure piston descending upon one side of the shaft is balanced by the force of the steam applied to the low-pressure piston ascending upon the other side, leaving only the weight of the crank shaft and its connections to be carried by the main bearing boxes.

Each motion in this engine has a corresponding opposite motion, producing a perfect balance at all angles of the cranks

and at all speeds. By this arrangement no strains escape from the cylinders, and the connecting-rods and cranks become the sole transmitters and controllers of all forces. It also transfers the fulcrum from the main bearing boxes to the center of the shaft. The weights and forces being equally applied to opposite crank pins, moving in opposite directions in the same plane the cranks become the beams, or levers of balance, and there being no weight of parts to be lifted and no friction due to steam pressures to overcome; the steam forces applied to the pistons and the momentum forces stored in its moving parts are all transformed into crank motion. Its absolute control of these

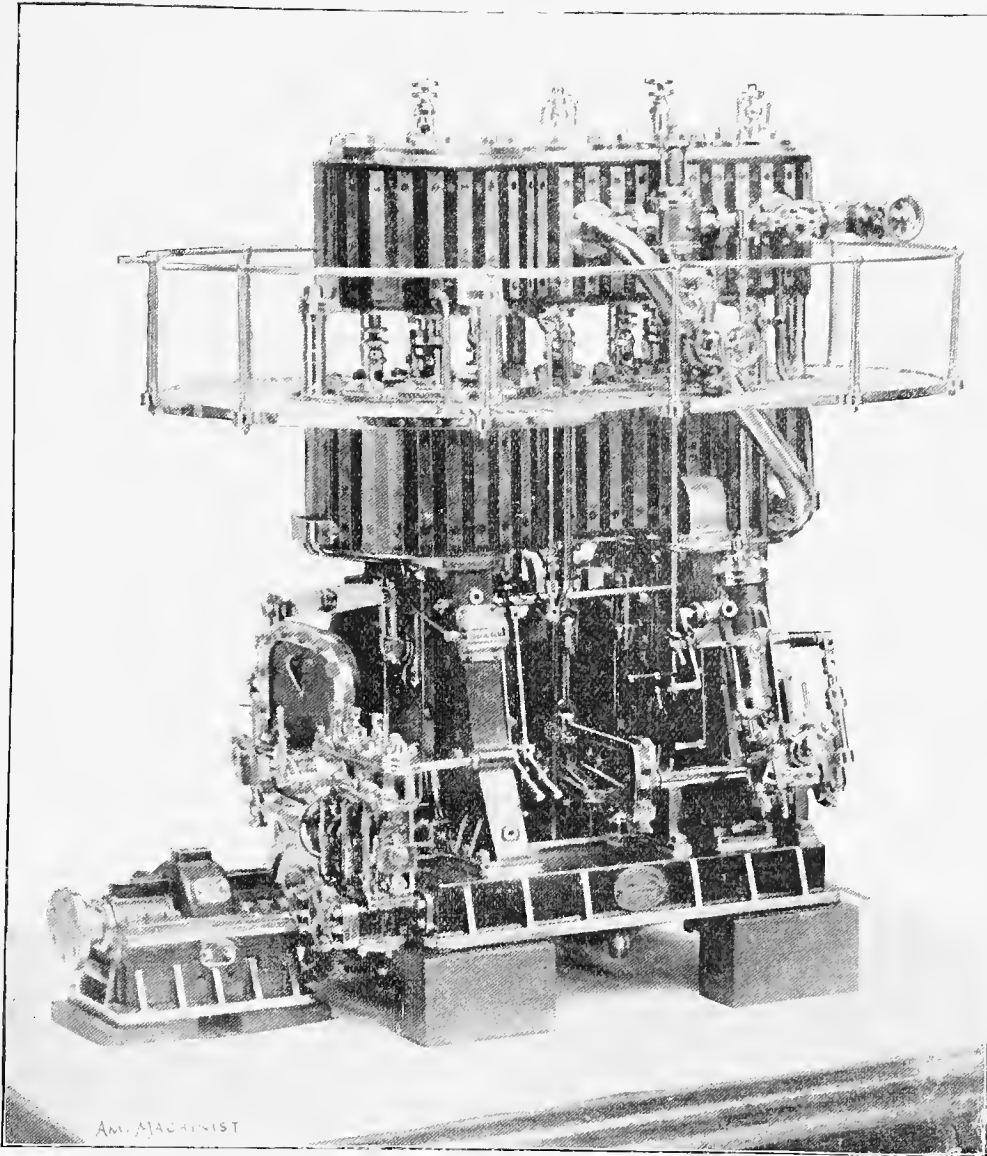

CHASE'S QUADRUPLE-EXPANSION MARINE ENGINE.

forces, for useful effect, greatly increases the power of the engine. It also gives uniformity of motion, its forces being equal around the circuit of the shaft; they are given out in the crank arms when the steam forces are diminishing, as the pistons are approaching the end of the stroke, acting the same as an ordinary fly-wheel in carrying them over the centers, producing a rotary motion.

ITS GREAT IMPORTANCE IN LARGE POWERS.

This principle embraces a very peculiar feature, directly the reverse of the general practice, which is of the highest importance; *i. e.*, the advantages gained by balancing the forces in the Wells engine increase in direct ratio with the bore of cylinder (tons being balanced in large, versus pounds in small engines),

while the losses from unbalanced disturbing forces in all other engines increase in the same ratio. Therefore, the greater the power, the more important it is to obtain a balance; and the relief of pressures afforded in the main bearing boxes by this system will readily be seen by multiplying the area of piston with the mean steam pressure, and the weight of the reciprocating parts by their velocity. For example, take an engine with cylinders 18 inches and 36 inches diameter with a mean steam pressure of 30 pounds, and a piston speed of 600 feet per minute, it relieves the main bearings of 19 tons pressure per stroke of pistons.

The principle embraces the most favorable conditions for the construction of large engines; the "balanced" double-acting levers, or cranks, have only their weight and that of the

rods to support between the main bearings, as they are relieved from the weight of the steam and the thrust of the rods. The forces being all transmitted in torsion, they have no tendency to leave their proper positions.

QUADRUPLED.

Two of these engines coupled closely together in one frame, each with cranks set at 180° , they occupy no more space than the ordinary fore-and-aft compound, and one-third less space than the triple, and embrace all of the advantages named in the foregoing description of the principle.

To those who are not familiar with this principle some conception of its vast importance may be gained by carefully calculating the useful effect of a perfect balance in the propelling forces, when applied to a ship equal in power to the *Majestic* where the combined area of the two low-pressure pistons is 20,414 inches multiplied by a mean steam pressure of $27\frac{1}{2}$ pounds gives a pressure of 280 tons per stroke of pistons; supposing the moving parts of the engine to weigh 60 tons and to have a velocity of 870 inches per minute, gives a further pressure of 600 tons per stroke or 320 tons in excess of the total steam pressure, and a combined pressure of 1080 tons per stroke, that must be resisted (that heretofore has never been controlled) by the engine frame bedplate hull of the ship, and finally by the ocean itself, into which a large percentage of the power escapes.

By the Wells system all forces are concentrated in the crank shaft, which prevent any escape, and at same time it relieves the engine frame and hull of all strains and vibration and the journals from heating.

DURABILITY AND CONSTRUCTION.

Unbalanced weight in motion (momentum) being the only element that tends to destroy an engine; makes it apparent that balanced weights, balanced steam pressures, and balanced motions are the qualifications necessary to produce a durable engine, all of which this design possesses in the highest degree. Practice proves it to be far more durable than any ever constructed; although subjected to extreme pressures and speeds, so far no part of the engine has failed, which is easily accounted for from the fact that all forces being perfectly balanced obviates vibration, injurious strains, and unnecessary friction, the only elements that tend to destroy the machine. Relieved of the pressure, the life of the main bearing boxes becomes practically unlimited, and the little wear that occurs on the main journals will be evenly distributed around their whole circumference. These engines are built by the Wells Engine Company, New York, from designs of Justin R. Wells.

Chase's Quadruple-Expansion Marine Engine.

These illustrations are taken from a working model of a disconnective quadruple-expansion marine engine built to a $\frac{3}{4}$ -inch scale by Frank Chase, of Hartford, Conn.

The principal dimensions of the full-sized engine would be: Diameter of high-pressure cylinder, 14 inches; first intermediate, 22 inches; second intermediate, 32 inches; low-pressure, 45 inches; stroke, 28 inches. Boiler pressure, 200 pounds per square inch. The engine is arranged on the tandem principle, the high-pressure and first intermediate

cylinders forming the forward engine, the second intermediate and low-pressure cylinders the after engine. The cylinders are jacketed with steam direct from the boiler, entering through an inlet valve and dropped into condenser. This enables them to be thoroughly heated before opening the throttle. At the same time a vacuum may be produced by starting up the circulating donkey-pump. In addition to the steam jacket is

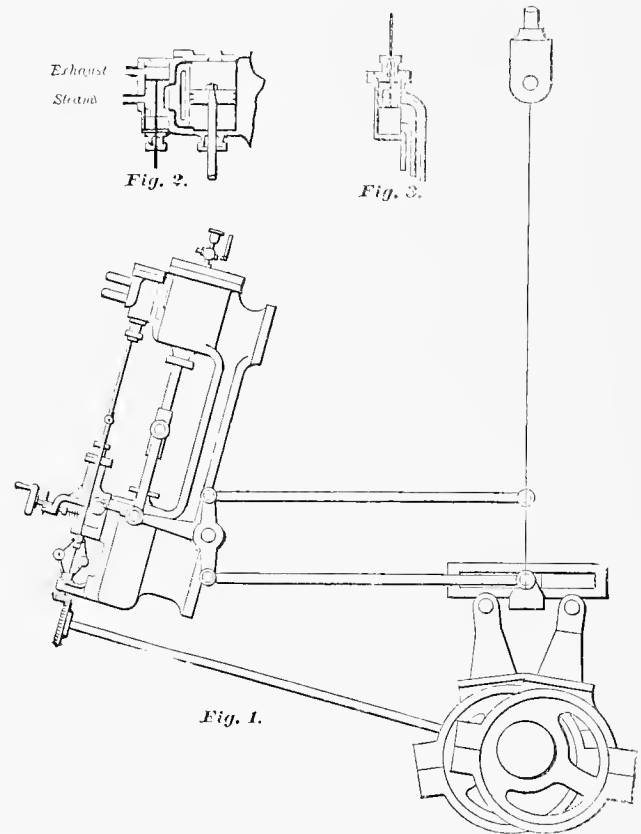

CHASE'S VALVE GEAR AND MARINE GOVERNOR.

a coating of asbestos, and a lagging of alternate strips of mahogany and white maple, which last has an effective appearance. The relief valves at each end of cylinders are made extra large; ample provision for draining cylinders and jackets is provided, together with indicator cocks and connections. The main valves are all of the piston type, and their upper portions in the upper cylinders are made slightly larger; this excess in area perfectly balances all the valve gearing beneath. The cylinder pistons are attached to their rods by means of an adjustable screw collar. This arrangement has the same feature of rigidity as the usual conical rod and nut, but in case of accident, or for adjustment, allows the piston to be readily removed. The piston-rods to the lower cylinders are made considerably smaller than usual by this method, thus slightly increasing the effective cylinder area. The stuffing boxes between the upper and lower cylinders are each made in two halves, bolted together, and furnished with split collar bushes. A long sleeve is utilized in place of one set of stuffing boxes; the sleeve also serves as an excellent guide to the

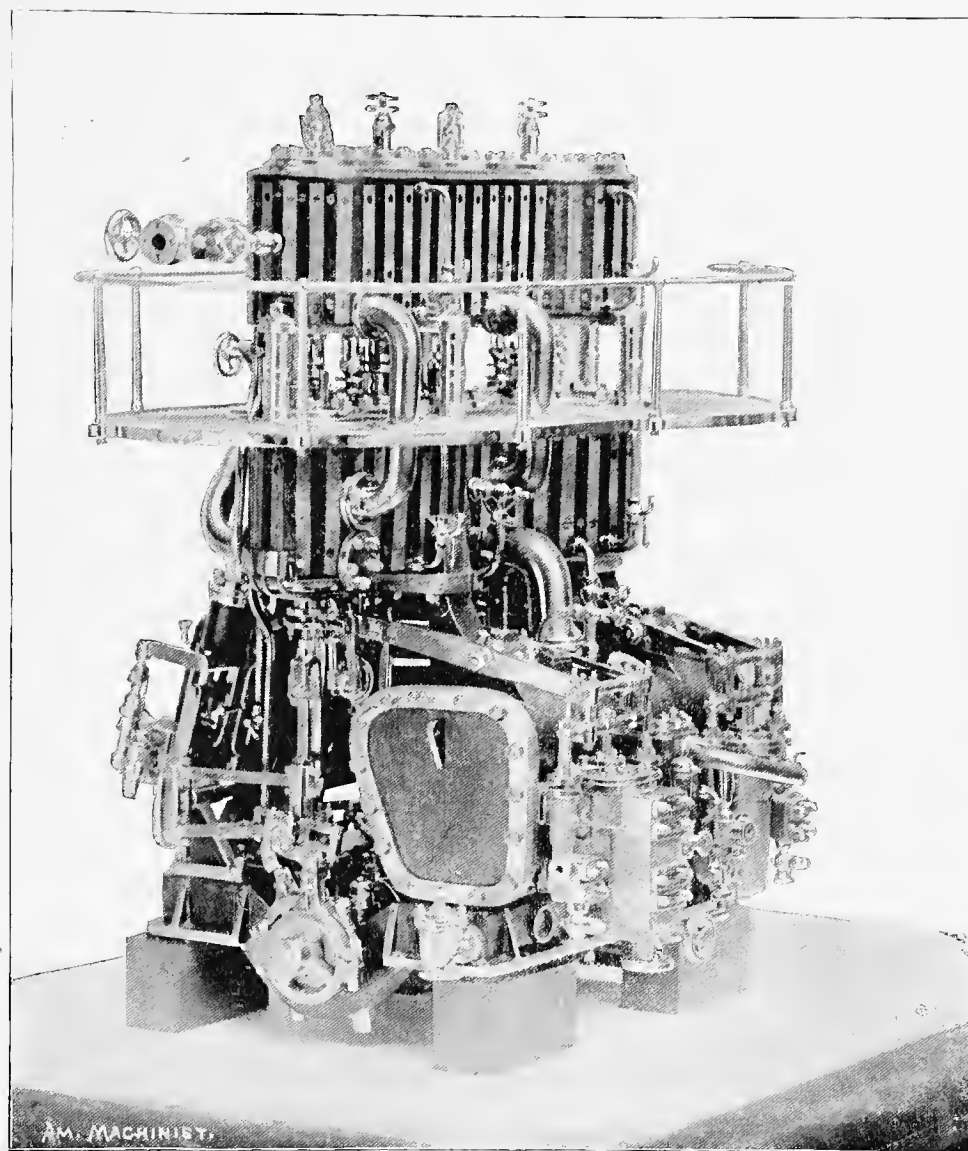

CHASE'S QUADRUPLE-EXPANSION ENGINE.

piston-rods. This arrangement dispenses with one set of stuffing boxes, shortens the distance between the cylinders, and enables obstinate cases of hard packing to be more readily dealt with. The upper cylinders are supported on six vertical columns, any of which may be readily removed for overhauling and repairs. The lower cylinders are supported at the back on the condenser, and in the front on cast-iron columns, the after column being utilized as an oil reservoir, and on this column the engine counter—which is of very simple construction—is attached. The go-ahead slides are detachable, and the shoes provided with brushes which dip into oil boxes at the foot of guides. The condenser is very efficient, the circulating water being circulated from the pump in two directions—around the condenser and through the tubes. Large, easily accessible

doors to the water side, with manhole and hand-holes to the steam side, are provided; also snifting valve at lower point. All the pumps, excepting the donkey, are worked from the main engine. There are two feed-pumps with separate air vessels, stop and relief valves; either pump is sufficient to supply the boiler under ordinary circumstances. They are bolted on considerably below the hot-well.

The auxiliary feed may be connected either to the circulating water or to an evaporator. The air-pump is single acting, and placed low down on the condenser. The circulating-pump is double acting, and of sufficient capacity for water of any temperature, the supply being, of course, regulated by main injection valve. There are also two bilge-pumps with their necessary stop valves and connections. All the pumps

are supplied with pet cocks, and the hot-well with water gauge, manhole and vapor pipe.

The crank shaft is in two sections, flanged and secured in the center by a dowel, which can be removed readily in case it is desired to run either engine separately. The main bearings have brass bushes in boxes; also oil boxes and siphon pipes. The bearing surfaces throughout the engine are made extra large and well supplied with means of lubrication. The

Allen straight link. By the method of suspending this link a sort of parallel motion is obtained, which greatly reduces the slipping of the block, and gives a quicker admission and cut-off. By means of a two-way valve to oil cylinder and lever to steam cylinder, reversing may be done quickly or slowly, and the cut-off fixed immovable at any point. The hand reverser consists of a small force-pump connected with the oil vessel, utilizing the same levers as the steam. In connection with the steam

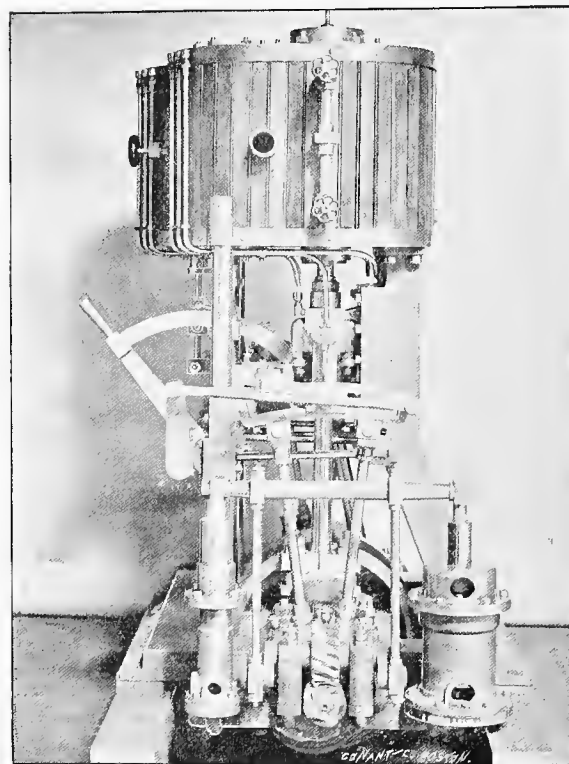
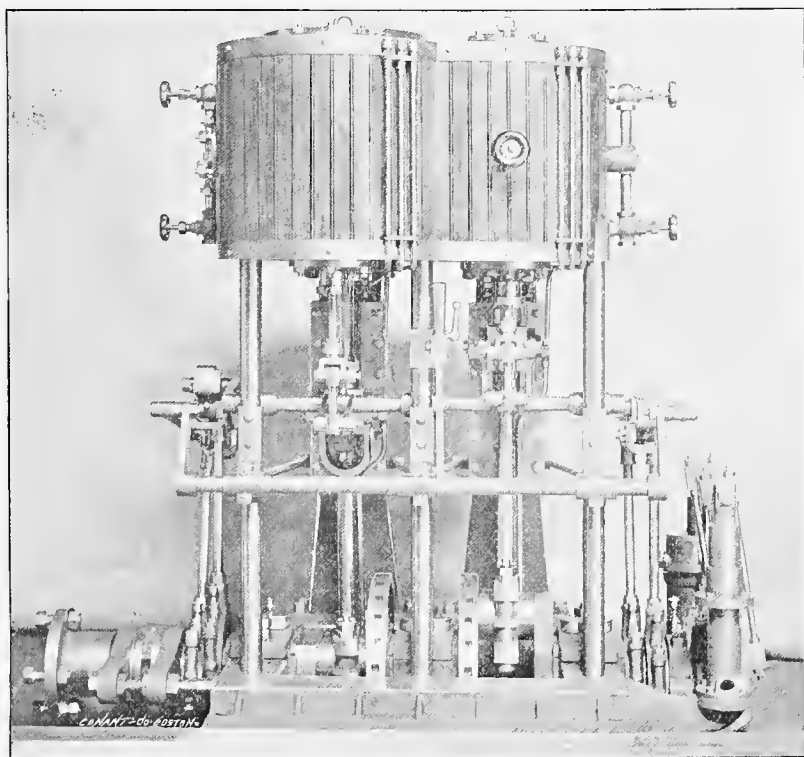

COMPOUND YACHT ENGINE, WITH AIR AND FEED-PUMP ATTACHED.—Designed and Built by the Edward S. Clark Co., Boston, Mass.

water service for cooling purposes is ample, and has universal joints for all parts; also hose connections for extreme cases. Back of the after-main bearing a gear wheel secured to shaft engages with a worm driven from an auxiliary engine. By means of a clutch and swinging bracket the worm may be thrown out of gear without causing delay. The auxiliary engine, when not in use as a turning engine, serves as a powerful pump for all purposes. It has two double-acting steam cylinders and pumps, and is remarkably compact. Slotted crossheads are used; there are no eccentrics; a cam on the shaft gives the necessary lead and cut-off when running in either direction, and reversing is effected by reversing the steam, all the pipes, etc., being cast with the cylinders and chests.

The main engines are reversed either by hand or steam. Steam reversing engine consists of a steam and an oil cylinder, the pistons of which are connected together, and give motion by links to the reversing gear, which is a modification of the

reversing gear is a positive governor, very sensitive in its action, connected by gearing to the shaft, and having perfect control over the main engine. The cut will explain its action. Fig. 1 is a general arrangement. Fig. 2 shows the balance valve to steam cylinder. Steam is admitted slightly to both sides of piston, and a short movement of valve in either direction by the sensitive governor reduces the pressure on one side of piston, the latter, of course, following in the direction of the reduced pressure, and moving the connecting link to valve spindle nearer to, or farther away from, the center of the slotted link, according to the speed of engine. The same movement of the balanced valve opens the valve to oil cylinder as shown in Fig. 3. When the engine is at its normal speed the oil piston is locked. Should any great acceleration of speed take place, due, for instance, to the breaking of the shaft, the link would be thrown into mid gear, thus shutting off steam completely from each and every cylinder in the main engine, nor would steam be again admitted except by operating the ordinary reversing lever,

which is not in any way connected with the automatic governor. The disconnective features of the engine are as follows: In case the forward engine breaks down, it is disconnected by removing the dowel in crank shaft. The valve between the two intermediate cylinders, together with the throttle valve to high-pressure cylinder, is closed, and the auxiliary pump used as a circulating pump. Steam is admitted to the second intermediate cylinder through the reducing valve, and the after engine is run as a compound condensing engine. This reducing valve is operated by a lever from the starting platform, and is useful as a blow through valve for turning centers in starting. In case the after engine breaks down, the connecting-rod is removed from crank pin and secured in an out-of-the-way position. The valve between the two intermediate cylinders is closed and connection made between first intermediate exhaust and condenser. The auxiliary pump is used as an air-pump and the forward engine then run as a compound engine. The thrust from the propeller is taken up on conical rollers running in oil, fitted with adjustable plates for wear; this arrangement reduces the friction considerably.

The engine takes up very little room fore and aft; every part is accessible for adjustment and repairs, and a system of duplication of parts is carried throughout.

The Hartford (Connecticut) Steam Boiler Inspection and Insurance Company, is interested in the introduction of this engine.

Clark's Compound Yacht Engine.

The two views are from photographs of the engines designed and built for the World's Fair launches. The cylinders are 6 and 12 inches in diameter by 8 inches stroke; cast in one piece, with the receiver, etc., enclosed inside of the lagging, which is of cherry, handsomely finished and held in place by brass bands. The valve chambers are set at right angles to the crank shaft, which greatly reduces the fore-and-aft space of the engine—a very essential point in a small engine-room. This also brings the valve chambers close together, making a quick passage of steam from the high to the low-pressure cylinder, thus doing away with the long outside exhaust pipe common to most compound engines. The cylinders are supported from the bed of the engine by cast-iron columns on the back side, forming the guides for crossheads, and on the front side by three steel posts, planed square in the center, to which are bolted the bearings for the rocker shafts operating the piston valves, also the bearings for reverse lever and braces from post to frame. The crank shaft is cut from solid steel forgings, with counterbalance fitted on the two inside cranks, which have notches in them for baring the engine over when cold. The crossheads, crank-pin boxes and all small connections are made of a high grade of phosphor-bronze, and the main bearings on the crank shaft are lined with Magnolia metal. The quadrant is attached to the reverse lever and made fast by a clamp on the center post, so that when the engine is in the go-ahead gear, the lever stands in an upright position and the quadrant is entirely enclosed in the engine proper. As will be seen, the air and feed-pumps are fastened to the engine bed, and are operated from the crank shaft by means of a worm and worm gear, which reduces the speed of the pump one-fourth the revolution of the engine, reducing the friction

and overcoming all noise made by the valves in all high-speed pumps.

The thrust bearing is also connected to the engine bed by two steel studs, and as the thrust collar is made fast to the shaft the adjustment is made by the two thrust bars, which have faces lined with Babbitt metal and held in place by double locknut on the two steel studs. These engines were designed and built by Edward S. Clark, Boston, Mass.

The Davis-Farrar Yacht Engine.

The triple-expansion yacht engines shown in cuts have cylinders 7, 10 $\frac{3}{4}$, 16 $\frac{1}{2}$ by 8 inches stroke. The high-pressure and intermediate-pressure cylinders have piston valves, in cages, bolted to false seats. The low-pressure cylinder has the double-ported Allen valve; all are operated by the Davis radial valve gear. The cylinders are supported at the rear by a hollow cast leg, the metal being disposed so as to give rigidity without excessive weight; at the front by polished wrought-steel columns, allowing the working parts to be under the eye of the engineer at all times, and adding greatly to their accessibility. The crosshead is of polished cast steel, carrying a slipper guide at the back, which operates on slides formed by face of the cast leg of frame, and with wrought guides to take the thrust when backing and being adjustable for wear. The crosshead pin is secured with a substantial dowel on one side and with a split bush with a keeper nut on the other. The pin is hollow and is oiled from the center; the brasses being grooved to thoroughly distribute the oil over the wear-

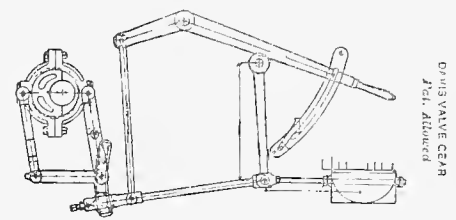

FIG. 1.

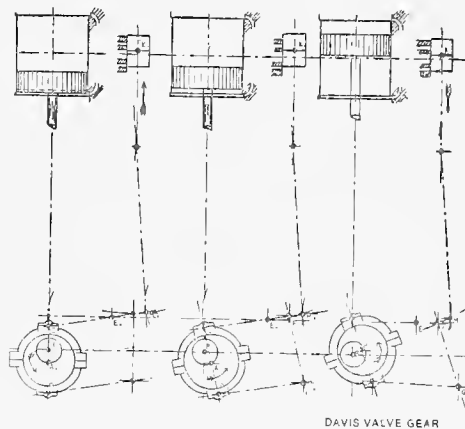
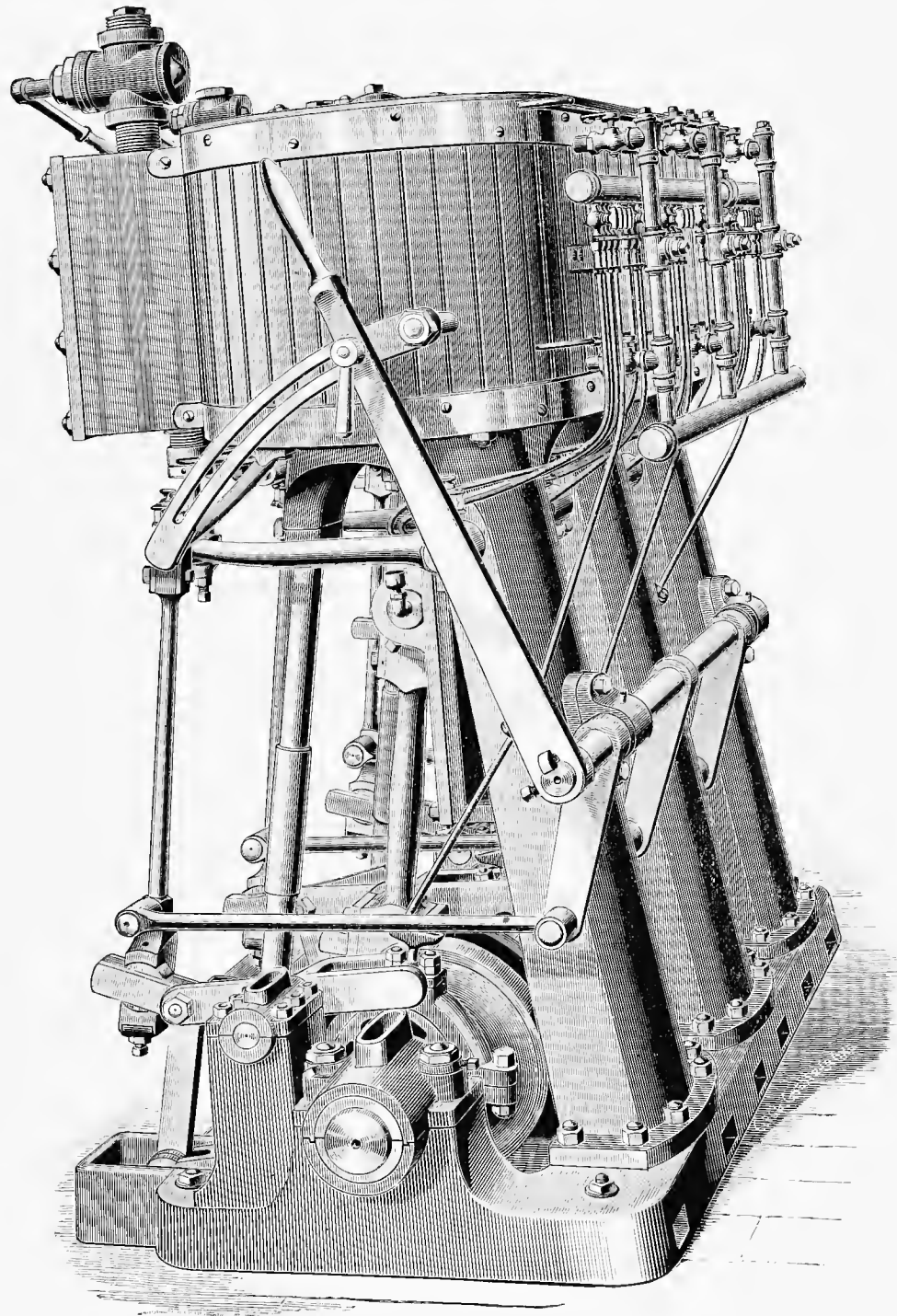
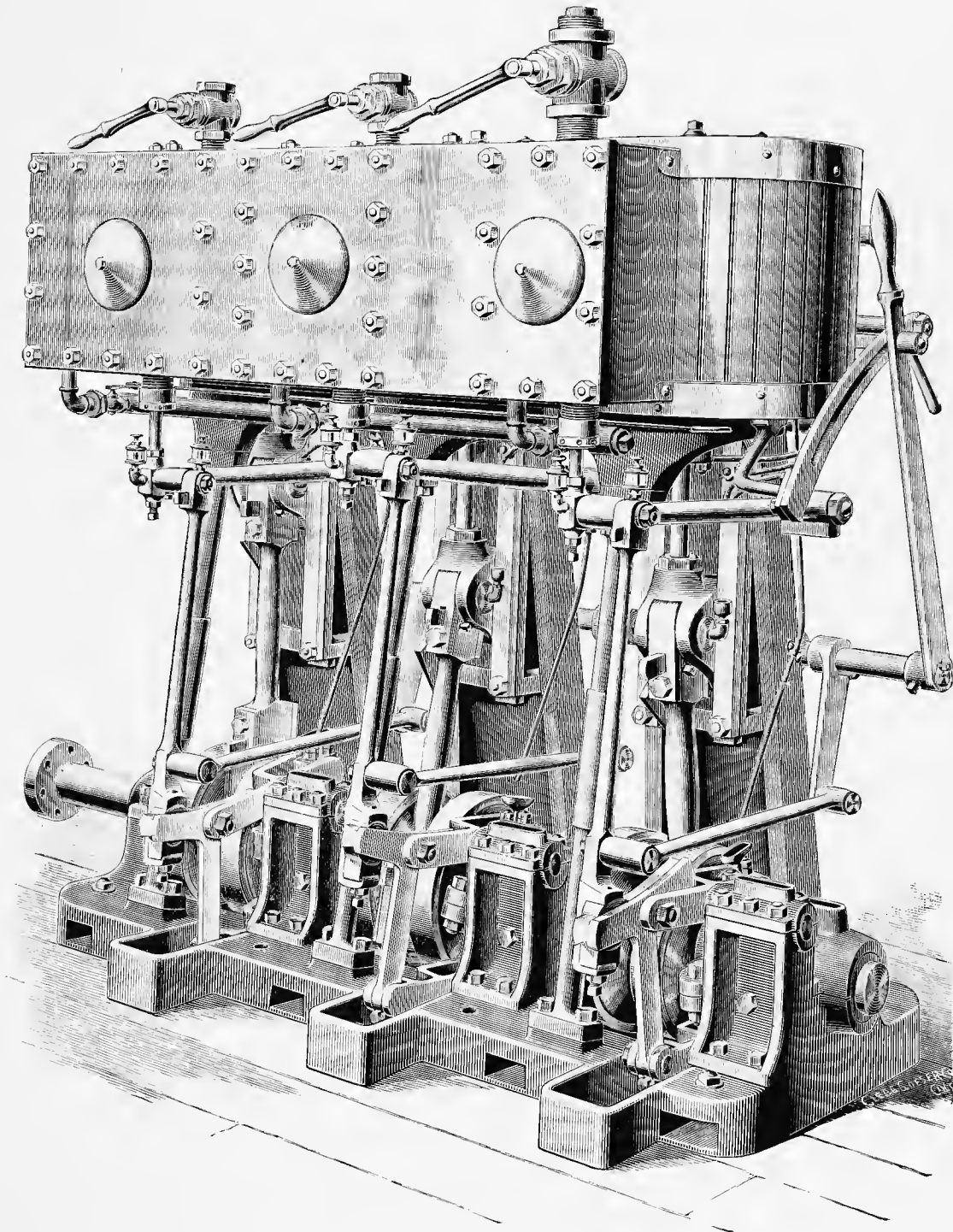

FIG. 2. FIG. 3. FIG. 4
The Davis Radial Valve Gear.



THE DAVIS-FARRAR TRIPLE-EXPANSION YACHT ENGINE.



THE DAVIS-FARRAR TRIPLE-EXPANSION YACHT ENGINE, WITH DAVIS' RADIAL VALVE GEAR.

ing surfaces. The shaft has coupling forged solid with it. The cranks have polished discs containing counterbalance weights. The pillow blocks have removable bushings, enabling the wear to be compensated for by shimming or removal at slight cost. Cylinder heads, steam-chest covers, and all working parts are highly polished. The method of oiling is shown in rear view, a brass pipe extending along the cylinders, from which smaller pipes branch, conveying oil to the journals, each being provided with a cock to regulate the supply. The engines have been designed for hard duty under high steam pressure, and have repeatedly on all day runs turned a 42-inch wheel, 6 feet pitch, 310 revolutions per minute, without worn journals or pins. In two years' service on the yacht Tallalusa, a set of these engines have never shown a worn pin or journal under 185 pounds steam pressure.

Great care is taken with the balancing of the engines. The steam distribution, as well as the weight in counterbalances, being carefully decided after extended experiments with each size engine. The importance of steam distribution is now very generally recognized by builders of high-speed engines. The valve gear has been designed with this especial object in view; its extreme simplicity will first attract the attention of the engineer; in operation it can be compared with the Corliss only. The fast and slow travel of the valve occurs at the desired points, and there is no perceptible difference in the events of induction, release or compression from full stroke to any point of cut-off down to zero. It is usually designed to cut-off at $\frac{1}{2}$ or $\frac{5}{8}$ stroke as maximum. Its construction can be understood from cuts, Fig. 1 showing the gear in skeleton. The eccentric strap has attached to its top and bottom sides an arm or link, each 12 inches long, the upper link being pivoted at a point 9 inches from center of pin connecting it to the top of eccentric strap. This fixed point is supported by a suitable stand bolted to the engine base. At its outer end is a quadrant, an arm of which extends downward and is connected to the lower link. It will be seen that the vertical throw of the eccentric, operating the upper link or lever over its fixed point, carries its outer end, to which is attached the quadrant vertically, a distance governed by the throw of the eccentric and the position of the "fixed point" or fulcrum, a distance equal to the lap and lead of the valve. The lower link connects the lower arm of the quadrant to the bottom of the eccentric strap. The horizontal throw of the eccentric imparts a "rocking movement" to the quadrant, and it is obvious that the position of the valve stem on the quadrant regulates the port opening for steam; when in the center, zero, there can be no port opening other than the lead, and as it is thrown toward either end more port opening is obtained. Its action can be seen in Figs. 2, 3 and 4. In Fig. 2 the engine is on the bottom center. The throw of the eccentric being down has raised the valve an amount equal to the lap and lead, and it is ready to take steam at the same time the full horizontal throw of the eccentric (its quick travel) is ready to throw the lower arm of the quadrant to the right and rock its outer end up, giving the port opening with the quickest travel of the eccentric. Fig. 3 shows the port open, and it will be seen that the vertical throw of the eccentric beginning would tend to close the port, while the horizontal throw rocks the lower arm of the quadrant further, and maintains the valve in its position. The one throw operating against the other, causes the valve to pause or slow up. In closing the steam port, in Fig. 4, it will

be seen that the vertical throw of the eccentric is at its quickest point, while the horizontal throw is at its slowest and will have little effect in opposing it. Two years' service has developed no weakness or faults, and the steam distribution given by it is all that could be desired, giving as it does a quick opening and closing of the valve with the slow travel at that point that allows a free admission and exhaust, and none of the objectionable features of the ordinary Stephenson link. These engines are built by the Davis-Farrar Company, of Erie, Pa.

The Joy Valve Gear.

The cut shows the ingenious arrangement whereby David Joy, of London, has avoided altogether the use of eccentrics. He obtains the motion from the connecting-rod, and qualifies it by a sliding block like Hackworth, or a suspension-rod like Marshall. The motion thus obtained is a very perfect one for a slide valve, as the two quick and two slow periods are just when required. The amount of opening is equal at both ends of the valve, and early cut-off can be effected without exces-

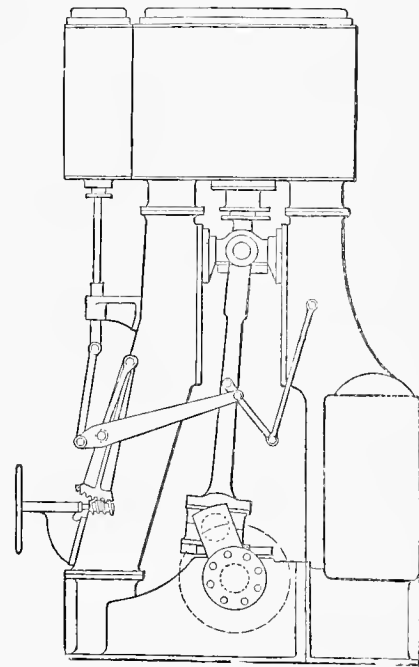

JOY'S VALVE GEAR.

sive leads and compressions or premature exhaustings. This gear has been applied with great success to locomotives, where the saving of space for the eccentrics admits of longer crank pins and journals; it has also been taken up by marine engineers. The chief objections to this gear are that it comes in the way of the principal working parts, and makes them a little difficult to get at when working, and also that a small amount of wear on the joints of the gear would cause a defect in the valve motion, and produce a serious amount of rattle of the gear.

These, however, can be got over by making the pins substantial and all the joints adjustable.

David Joy, of London, has recently designed an arrangement of reversing gear for marine engines, by means of which link motion is done away with and yet the effect of linking up can be obtained, whilst reversal of the engine is under perfect control. This result is accomplished by putting a pair of hydraulic cylinders in the eccentric sheave, and in this way can shift it to an equivalent of any position on the shaft, from full gear ahead to full gear astern, whilst the intermediate position naturally brings it concentric with the shaft, so that the valve has no motion at all.

The Marshall Valve Gear.

This arrangement of slide-valve gear, which has been fitted by R. & W. Hawthorne, Leslie & Co., Newcastle-on-Tyne, to a large number of marine engines, including those of several recent ships of the Royal Navy, is illustrated in Fig. 103. In this system only one eccentric is used, the end of

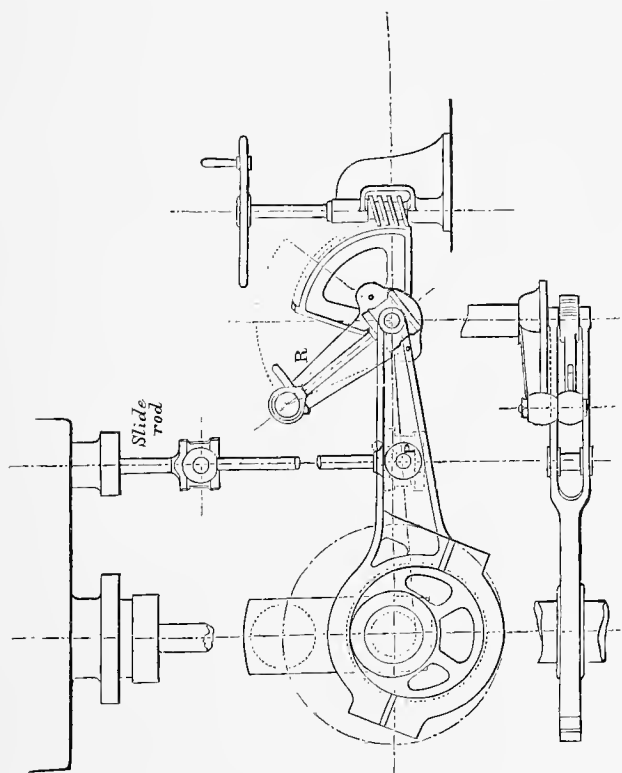

FIG. 103. MARSHALL VALVE GEAR.—From the Marine Engine, by Richard Sennett.

the eccentric-rod being attached to a rod hung from a pin on the reversing shaft lever R, by which it is constrained to move in an arc of a circle inclined to the centre line. To an intermediate point, P, in the eccentric-rod a connecting link is attached which communicates the necessary motion to the slide-valve rod. By adjusting the position of the

reversing lever R, any desired degree of expansion can be obtained or the engines reversed as required. In this system there are few working parts, and the distribution of steam both for full power and for expansive working is satisfactory.

RICHARD SENNETT.

Marshall's valve gear is a modification of Hackworth's, and differs from it in the method of getting the oblique motion of the rod-end. Fig. 68 shows the plan adopted by F. C. Marshall, of Newcastle-on-Tyne, and also illustrates generally what has been said of Hackworth's. Here the eccentric-rod is hung, by means of a rod from the end of a lever, on a reversing shaft in such a way that it moves on the arc of a circle inclined to the centre line. The motion is not quite so perfect as with the inclined sliding bar, and necessitates double ports to the bottom end of the slide valve in order to get as much opening to steam there as at the top end; but there is less friction, and, on the whole, it works most satisfactorily. The pins require to be of good size, and they should all have adjustable brasses to provide for the large amount of wear which of necessity comes on them.

A. E. SEATON.

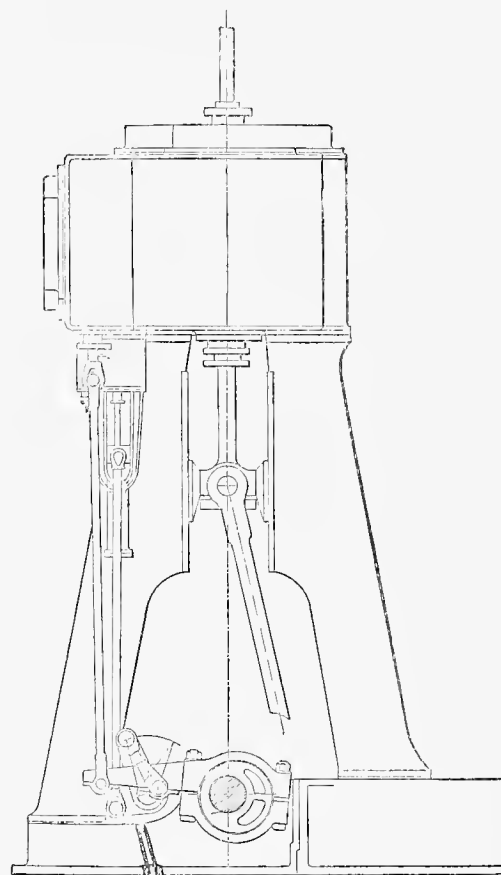

Marshall's Patent Valve Gear.

FIG. 68. DRAWN BY A. E. SEATON, OF EARLE'S SHIPBUILDING WORKS, HULL, ENGLAND.

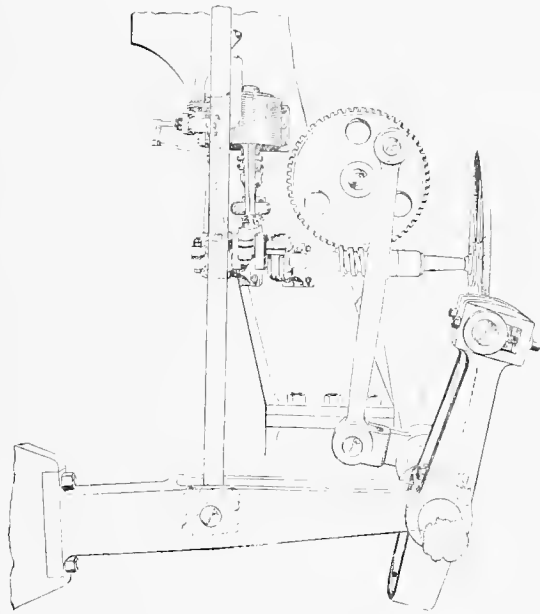

DETAIL OF MARSHALL'S VALVE GEAR.

Canfield's Patent Balance Valve.

The engraving shows a vertical steeple compound engine with but a single valve to operate both cylinders. There is no receiver, the exhaust going direct to the low-pressure cylinder through the valve itself. The engine, as shown, has a high-pressure cylinder 18 inches diameter, and a low-pressure cylinder 36 inches diameter, the steam chests on both cylinders connecting with a conduit of sufficient area to equalize the steam pressure on both ends of the hollow piston valve, rendering it perfectly balanced, the difference of areas in the tail-rod and valve stem being so proportioned that the weight of the valve is balanced by the difference of pressure on the top and bottom heads. It will be seen that there is but one valve for both cylinders, the valve itself taking the place of a receiver. This arrangement reduces the unavoidable loss in the receivers commonly used, in the increase of volume and condensation in passing the steam from one cylinder to the other. The plan is the device of Hobart Canfield, of Morristown, N. J. In this system, the valve being jacketed by live steam at boiler pressure, any moisture due to the first expansion is reheated by the live steam as it passes through the valve from the high to the low-pressure cylinder, and the condensation is reduced very materially. Cards taken from one of these engines with an initial pressure of 100 pounds in the high-pressure cylinder, cutting off at $\frac{5}{8}$ stroke, show 26 pounds initial in the low-pressure cylinder, thus proving that the increase in volume between the cylinders is reduced to its lowest terms, for in this system the pressure is about double that which would be indicated if a common receiver were used.

This system has been practically tested, and the inventor, Mr. Canfield, has several engines from 500 to 1,500 horsepower in service. The patentee of the valve is Master Mechanic at the Pennsylvania Railroad Shops in Hoboken, N. J.

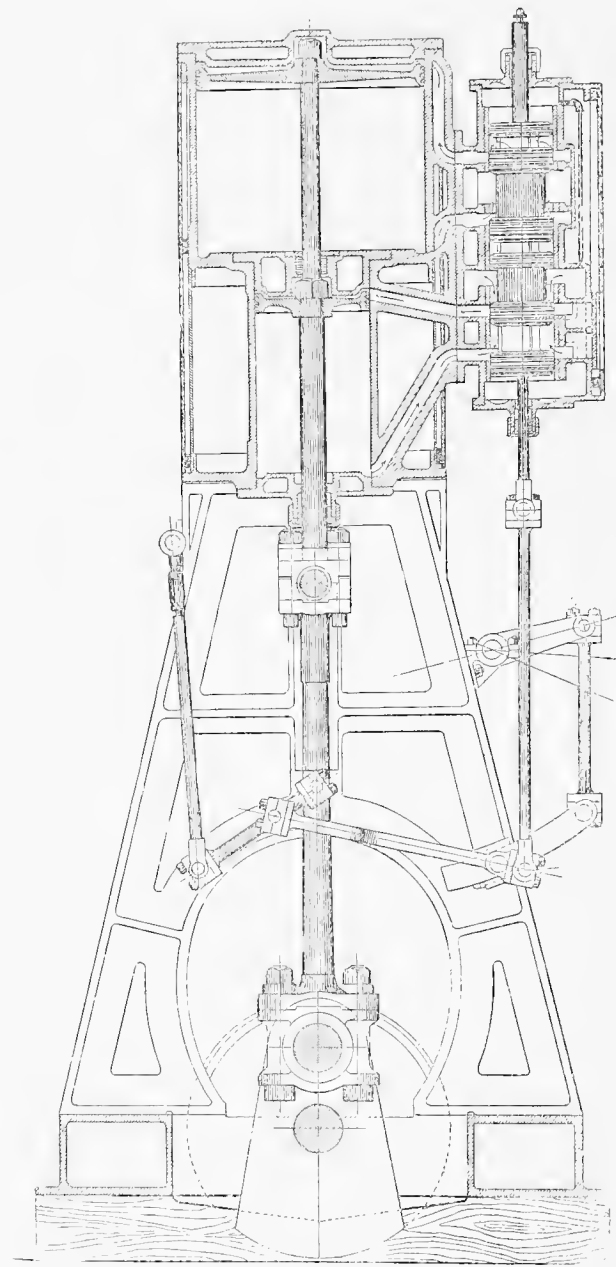

STEEPLE COMPOUND ENGINE WITH CANFIELD'S VALVE.

Bonner's Patent Compound Balance Valve.

A very ingenious valve has been designed by John Bonner, Master Mechanic, of Tiburon, Cal. This valve simplifies the handling of compound engines in a marked degree, making it very economical in both water and fuel. The cut illustrates a steeple compound engine equipped with this valve, which, as will be seen, dispenses with the steam chest and steam receiver. An engine of this description, equipped with a Bonner compound balance valve has been in operation for the past year in

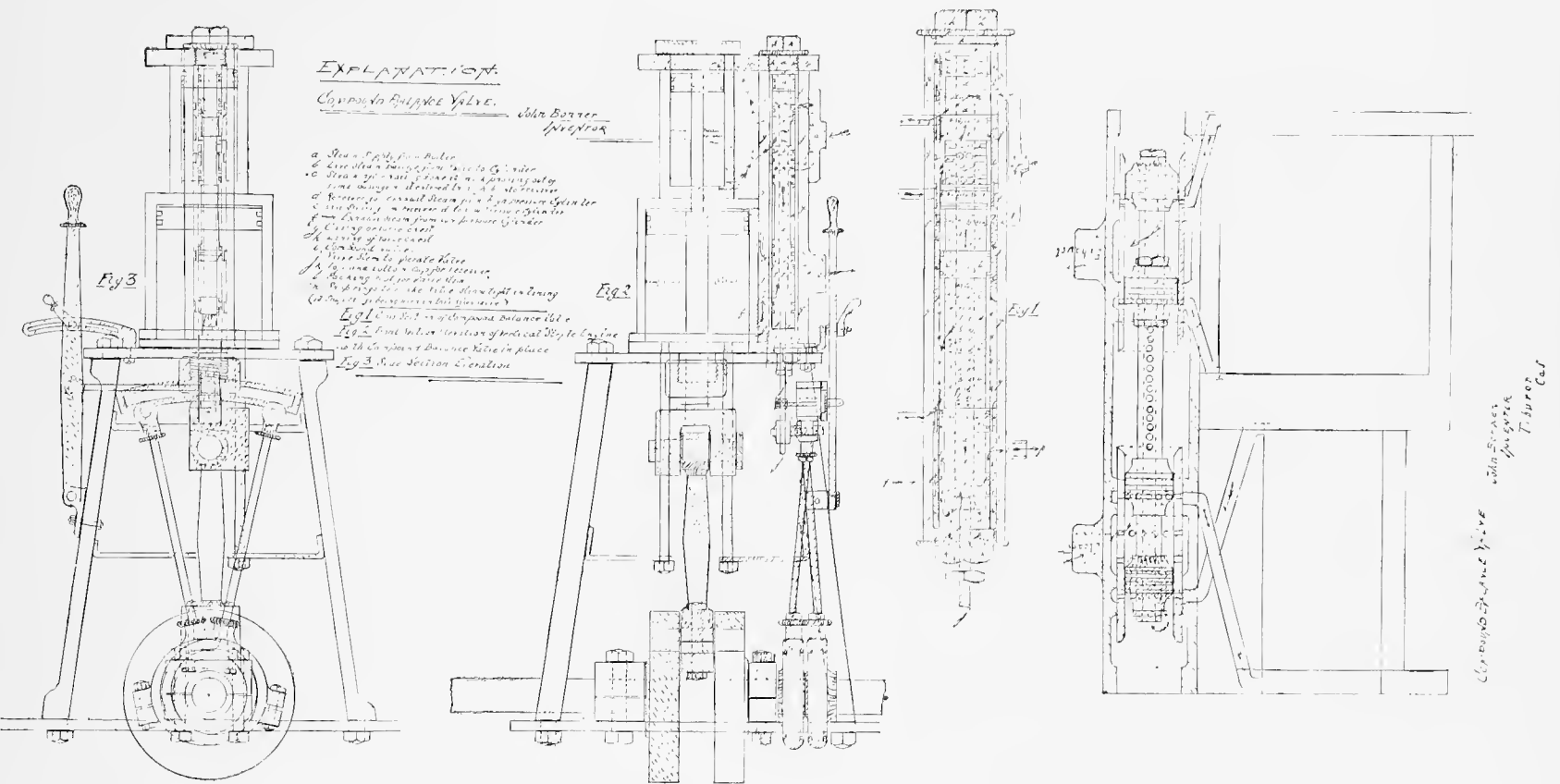

BONNER'S PATENT BALANCE VALVE.—Designed by John Bonner, Tiburon, Cal.

a 30-foot launch with 6 feet beam, and drives the boat 10 miles an hour. In connection with a water-tube boiler, patented by the same inventor, steam is generated very quickly with a consumption of but little fuel. The dimensions of this engine and boiler are: High-pressure cylinder, 238 inches; low-pressure cylinder, 4 $\frac{1}{4}$ by 4 $\frac{1}{4}$ inches; height from base to top of high-pressure cylinder, 27 inches. Weight of engine, 90 pounds. Boiler has 3 square feet of grate surface and a large heating surface. The boiler weighs, with casing, 350 pounds, and measures 20 by 24 by 34 inches. The United States Government license permits a pressure of 250 pounds, although 180 pounds is about the average used in running the launch. With this pressure, the 22 $\frac{1}{2}$ -inch propeller wheel makes 350 revolutions per minute on a consumption of from 15 to 20 pounds of good steam coal per hour. The construction of these valves is very simple, and there is nothing about them to get out of order. It is so perfectly balanced that by its use all the valve gearing, eccentrics and straps can be made one-third of the weight of an ordinary engine of the same horse-power. The engine frame and base are made of steel as light as possible, combined with strength.

The Sullivan Triple-Expansion Yacht Engine.

The increasing interest now taken in steam yachting has necessitated a better class of machinery than heretofore. Speed is now of the first importance, though most owners are particular about the appearance of their engines and wish them to be as attractive as possible. The illustration represents a triple-expansion engine built by John W. Sullivan, New York. The cylinders are all three in one casting so as to save weight, the back of columns which carry the guides for the crossheads, are all cast hollow of steel and the bedplate is also of steel for the same reason. Piston valves are used throughout, driven by Bremme gear so that the engine is very open in appearance, easy of access and greatly simplified. Light steel columns support the front of the cylinders. The crank shaft and eccentrics are forged steel in one piece, while the connecting and piston-rods, valve gear and all bolts and nuts are also steel. The connecting-rods are bored through the centre in order to further reduce the weight. The air and two feed-pumps are a single bronze casting, motion being obtained from the low-pressure engine through the medium of light steel levers and

links. The thrust bearing is arranged on the after end of the engine bed where it is under the immediate supervision of the engineer. The space occupied by these engines fore and aft is one-third less than is required for the ordinary style of construction, while the entire engine can be oiled and inspected from the starting platform. On a recent trial of one of the small sizes of these engines some remarkable results were obtained. The diameters of the cylinders were 5, 8 and 13 inches, respectively, with a common stroke of 8 inches. With a boiler pressure of 200 pounds, the number of revolutions made was 400, which is equal to a piston speed of 533 feet. Calculated percentage of admission, small cylinder, 70; intermediate cylinder, 60; large cylinder, 70. Horse-power estimated 38, 39½ and 40½, respectively, or 118 horse-power altogether. The entire weight of engine, including air and two feed-pumps, is 2,480 pounds. The propeller was 38 inches diameter by 6 feet pitch, and the speed attained was over 17 miles per hour. The vacuum maintained was 26 inches, which is very remarkable considering the high number of revolutions, while the engines were absolutely noiseless and developed no tendency to heat or cause trouble in any way. On the score of economy these engines make a most satisfactory showing, furnishing a horse-power for 1.61 pounds coal per hour, which is equivalent to less than one ton of coal for ten hours steaming, or a distance run of about 200 miles.

Engines of the Yacht Neaira.

These engines (illustrated by Fig. 1) were designed and patented by T. Main, Arlington, N. J., and constructed by R. Wetherill & Co., of Chester, Pa. The Neaira is built of steel, and is 110 feet long on the water line, 20 feet beam, and 10 feet deep, with 7 feet 3 inches draught of water aft; mean draught, 5 feet 10 inches; speed, 13.6 knots an hour.

The engines are of the balanced compound type; the high-pressure cylinder is 15 inches diameter, and the low-pressure is 28 inches diameter by 16 inches stroke; the cylinders are placed at an angle of about 23 degrees apart, and the cranks are directly opposite, so that the working parts of the one engine very nearly balance similar parts of the other. The pistons work in opposite directions, consequently the pressure of one piston is nearly balanced by that of the other through the crank, and the pressure on the shaft journals is reduced. This causes a great reduction of friction in passing the centers, and consequently increases the power.

These engines require only two journals, which makes a great reduction of length in a fore-and-aft direction, and which, in this vessel, allowed for an additional row of staterooms athwartship, which was a very great advantage to the owner. The valve motion is taken from the connecting-rods, and piston valves are used on both cylinders, which are controlled by one starting handle for starting, stopping, going ahead, backing, or working expansively. And owing to the engines being at an angle to each other they have no dead centers, but can be controlled under all conditions.

The surface condenser is located on one side of the engines, with independent air and circulating-pumps under it. The feed-pump is also independent. The thrust bearing is bolted to the bedplate, and accessible in the engine-room. In this type of engines the journals require less wearing surface than usual, and tend to remain cool when running fast, owing to the work

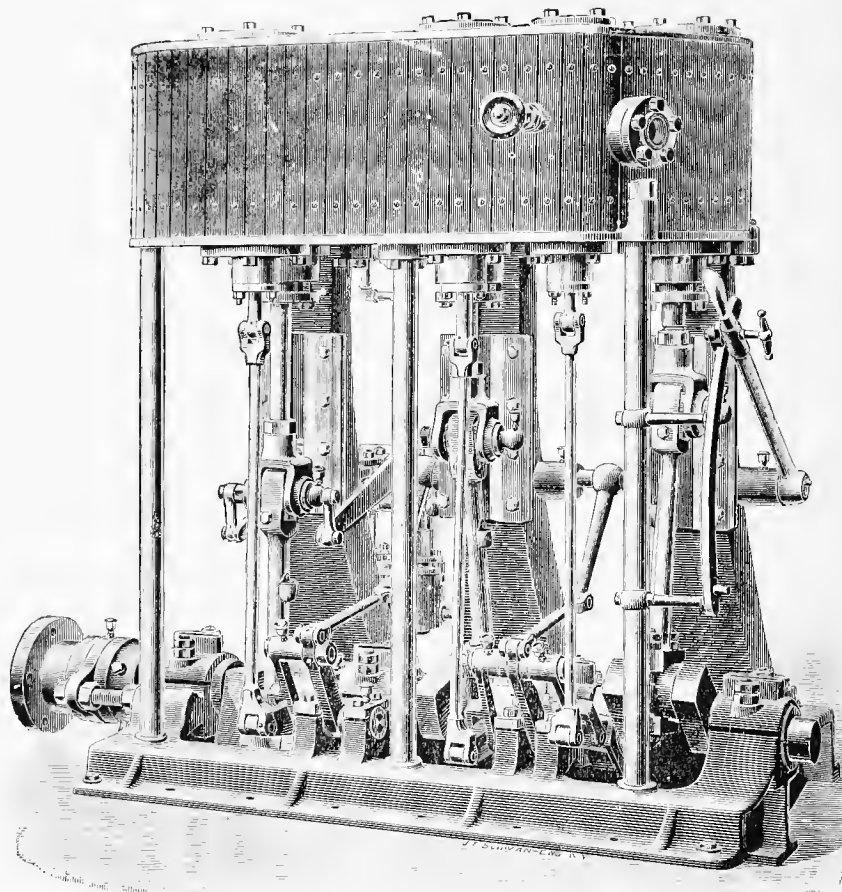

SULLIVAN'S TRIPLE-EXPANSION YACHT ENGINE.

on them being light. It is believed that there is no type of engines before the public to-day so compact as these, or which admits of so much power being located in so small a space. Steam is supplied at a pressure of 125 to 150 pounds by a Scotch type of boiler (illustrated by Fig. 2) with two corrugated furnaces 33 inches diameter; the boiler is 8 feet diameter by 10 feet long, has a steam drum and an air heater located at the base of the smokestack.

T. Main's system of hot blast is fitted to the boiler. A fan blower, driven by a pair of balanced compound engines 3½ and 6 inches diameter by 4½ inches stroke, is used to draw air from over the boiler, and forcing it through the air heater into the closed furnaces; 80 per cent. of this air goes under the grate, and 20 per cent. of it above, at a temperature of 220 degrees. This vessel has run several times from New York to New London, a distance of 110 statute miles, in seven hours, consuming two tons of coal during the run. The engines have been run at a maximum speed of 180 revolutions, with 150 pounds steam, and indicated 348 horse-power. They have been used during eight yachting seasons, very little has been done to them, and they are now in good condition. A modified plan of the blowing engines on this yacht is illustrated by Fig. 3, adapting them for use on small yachts or launches, for running dynamos, blowers, or for stationary work.

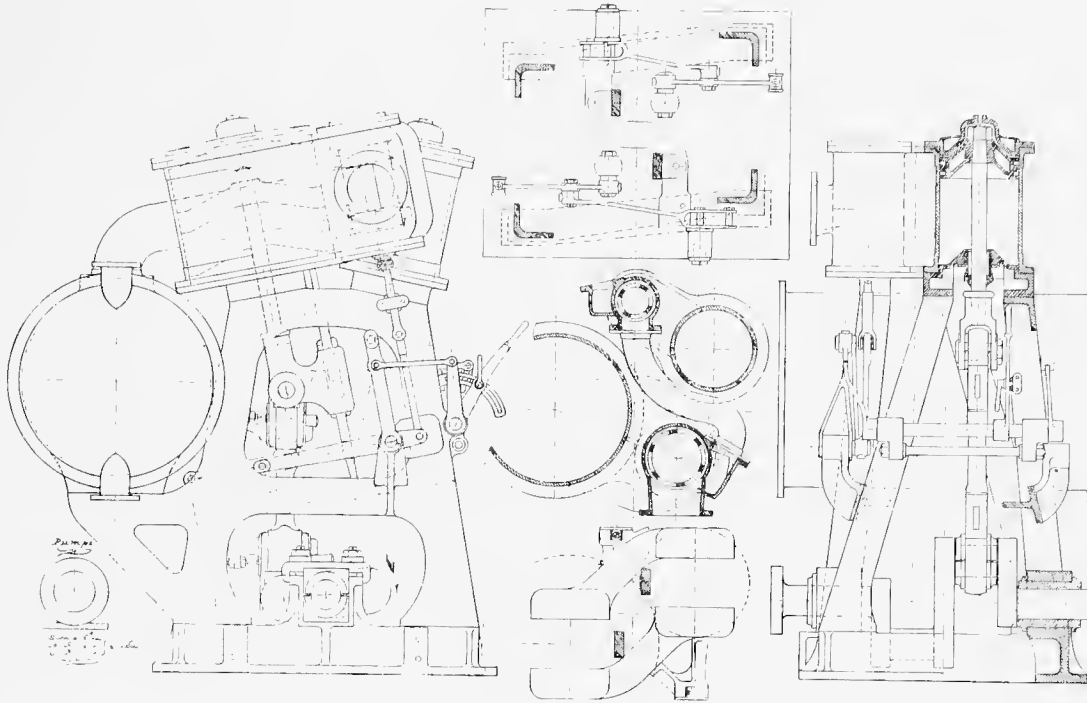

FIG. 1.

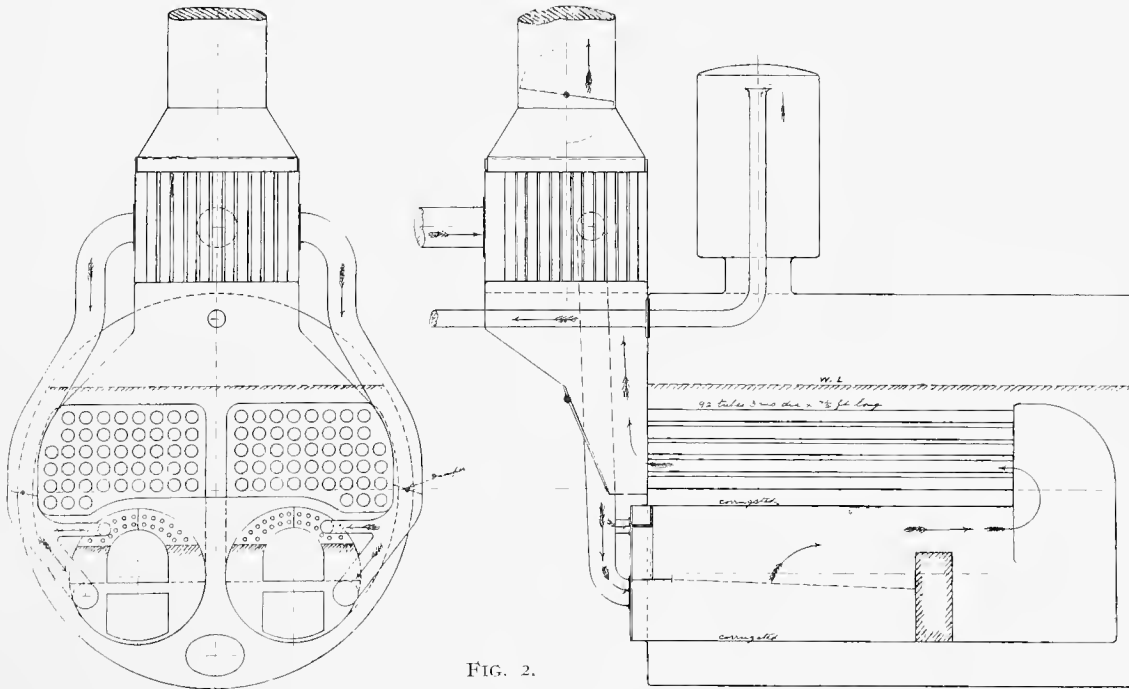

FIG. 2.

ENGINES AND BOILER OF STEAM YACHT NEAIRA.

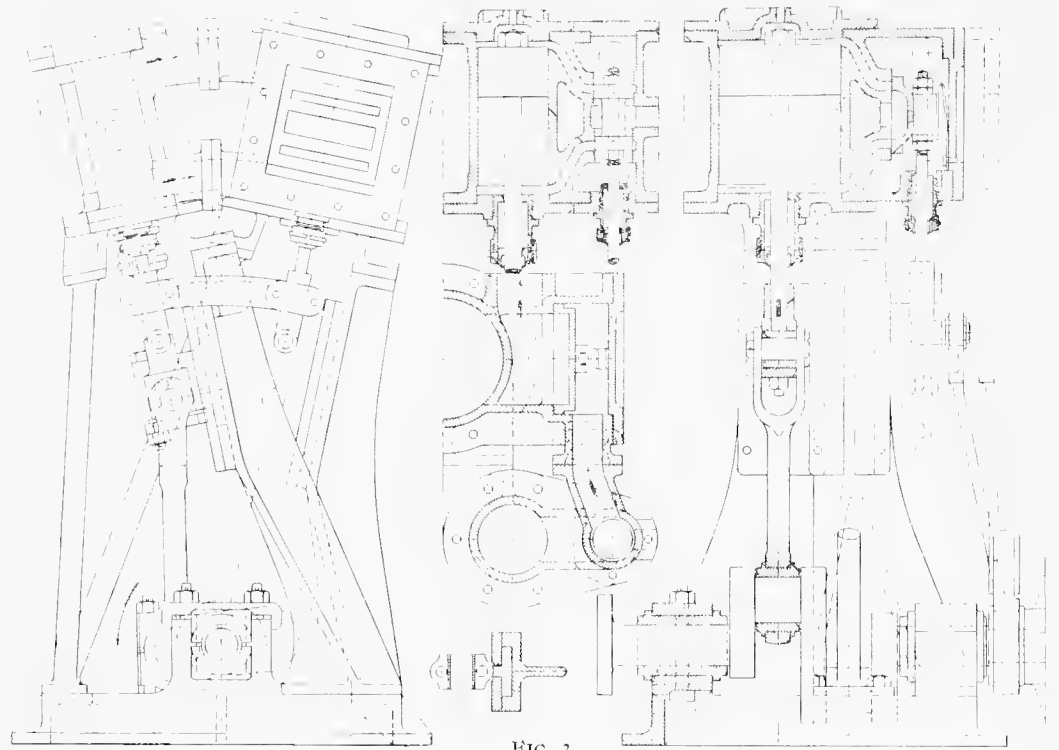

FIG. 3.

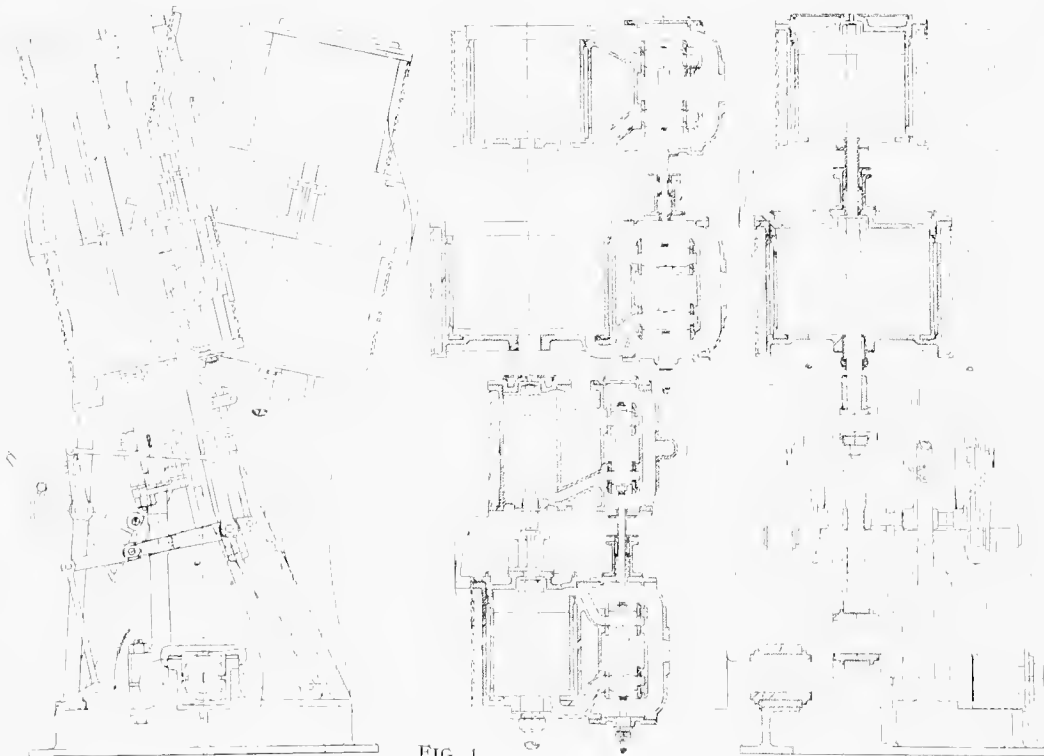

FIG. 4.

MAIN'S PATENT BALANCED ENGINE IN STEAM YACHT NEAIRA.

When it is an object in addition to compactness to attain a high degree of economy of fuel (and it always is or should be) these balanced engines can be arranged as quadruple-expansion engines, fitted with steam jackets, to use steam of 200 to 250 pounds pressure, supplied from water-tube boilers, such as Bellville, Almy, Roberts or similar boilers, fitted on the hot-blast system. It is claimed such a combination will produce an indicated horse-power on one pound of coal per hour when properly carried out and worked. Fig. 4 represents the engines of the *Neaira* modified as balanced quadruple tandem engines, fitted with steam jackets on three cylinders, and so arranged with movable stuffing boxes that the lower pistons, cylinder heads and valves can be removed without disturbing the upper cylinders, and all this will occupy no more space than an ordinary single upright engine.

Three Cylinder Compound Engines of Steamer *Pleasure*.

The boat whose engines are illustrated on another page, is a wooden vessel built in 1894 by F. W. Wheeler & Co., West Bay City, Mich., for the Belle Isle and Windsor Ferry Company. She is to run on the Detroit River, touching at Belle Isle, Windsor, and other summer resorts. The distance between stops being too short to obtain the full benefits of a triple-expansion engine, it was decided to adopt a three-cylinder compound engine, thereby retaining the smooth working of a triple-crank engine. The high-pressure cylinder is 24 inches diameter, and the two low-pressure cylinders are 34 inches diameter each, with a common stroke of 24 inches. The high-pressure cylinder is placed in the center so as to equalize pressures and passages. Each cylinder is fitted with relief valve, and a 3-inch starting valve is provided to admit live steam into both low-pressure cylinders. The engine is designed for a piston speed of 500 feet per minute. The ports in the high-pressure cylinder are 2½ inches wide and 19 inches long, and both low-pressure cylinders have ports 3 inches wide and 26 inches long. The main steam pipe is 7 inches diameter, the receiver pipe is 8 inches diameter, and the exhaust pipes leading to condenser are each 9½ inches diameter. The throttle valve is of the balanced cylindrical type, and fitted with suitable relief valve so as to work freely. All cylinders are fitted with valve-chest liners of hard, close-grained cast iron, with diagonal bridges and ports 2 inches wide. The high-pressure valve is 11 inches diameter, fitted with solid ring so as to be easily renewed, and the low-pressure valves are each 15 inches diameter, fitted with self-setting spring rings. The outside lap on the high-pressure valve is 1 3-16 inches on top, and 1 inch on bottom, and 3-16 inch inside lap on bottom; the low-pressure valves have 1 9-16 inches lap on top, and 1 3-8 inches on bottom, with an inside lap of 3-16 inch on bottom. All valves have a travel of 5 inches, and are worked directly by the Stephenson double bar link motion provided with adjustable cut-off arrangement. Steam is cut off at 0.75 stroke in high-pressure cylinder, and 0.65 stroke in low-pressure cylinders when in full gear. All valve stems are of machinery steel 2¼ inches in diameter, and are guided by adjustable valve stem guides with brass bushings. The engine is provided with steam reversing gear, having a cylinder 8 inches diameter and 12 inches stroke, operated by a differential valve motion under easy control of the engineer. The pistons are of cast iron 6 inches

deep fitted with adjustable spring rings. The piston-rods are of machine steel 4 inches diameter, secured to crossheads and pistons by tapered ends and nuts. The crossheads are of wrought iron, with gudgeons and slippers forged on. The slippers are provided with brass gibs 10 inches wide and 14 inches deep. The connecting-rods are of wrought iron 6 feet between centers, having the upper end forked to suit the crosshead pins, which are 4¼ inches diameter and 4 inches long. The upper ends are turned 3¾ inches diameter, and the lower ends 4¾ inches diameter. All bolts in connecting-rods are of steel 1¾ inches diameter at the upper ends, and 2¼ inches at the lower ends. The crank-pin brasses and all main journals are lined with Magnolia anti-friction metal in strips. The cylinders and valve chests have a magnesia covering, and are lagged with highly polished cherry. They are supported by six cast-iron columns, the port columns being provided with large bearing surfaces and water jackets for the slides. Through bolts are used wherever practical throughout the whole engine. The bedplate is of the box type cast in one piece, with six main journals, and raised feet for columns. All main journals are provided with cast-iron caps secured by two 2½-inch bolts. The crank shaft is made of wrought iron of the built-up type, and is 9 inches diameter. The crank arms are 5½ inches thick for the forward low-pressure, 6 inches for high-pressure, and 6½ inches for the after low-pressure, with a common width of 16½ inches at the pins, and 18 inches at the shaft.

The cranks are placed 120 degrees apart with the forward low-pressure leading the high-pressure, and the after low-pressure following. The three thrust collars are forged on crank shaft and are 15½ inches diameter and 2½ inches thick. The thrust bearing is bolted to the bedplate and is of the horseshoe type, with four cast-iron columns with anti-friction metal facings adjustable by means of steel bolts and brass nuts. The collars are designed for a pressure of 50 pounds per square inch, and a line bearing 9 inches wide is cast on the thrust block to support the shaft, while a similar bearing supports the line shaft. The stern tube is of cast iron 18 feet long, with an internal bearing at the forward end. The stern bearing is bolted to the stern post, and is of cast iron with a cap 20 inches long lined with lignum-vitæ, and adjustable by means of a rod running through stern post. The line and propeller shafts are 9 inches diameter, and 9½ inches diameter at the bearings. The propeller wheel is 10 feet diameter and 13 feet pitch; it is of the cast-steel dovetail type, patented by the Dry Dock Iron Company, of Bay City, Mich.

Steam is furnished by two cylindrical return tubular boilers 10 feet in diameter and 12 feet long, designed for a working pressure of 135 pounds per square inch. Each boiler has two furnaces, 40 inches diameter and 9 feet 3 inches long, and 152 3-inch tubes, giving a total grate surface of 78 square feet, and a total heating surface of 2,554 square feet. The boilers were built by Wicks Bros., Saginaw, Mich. All pumps are independent and were supplied by Dean Bros., of Indianapolis, Ind. The air-pump is single acting, steam cylinder 12 inches diameter, water cylinder 16 inches diameter, and a stroke of 12 inches. The feed-pump is of the duplex, outside packed, plunger type, 10 by 6 by 12 inches. A suitable fire-pump, bilge-pump, and water-service pump for tanks are also provided. The exhaust steam from all pumps passes through a feed-water heater, 20 inches diameter with 52 1½-

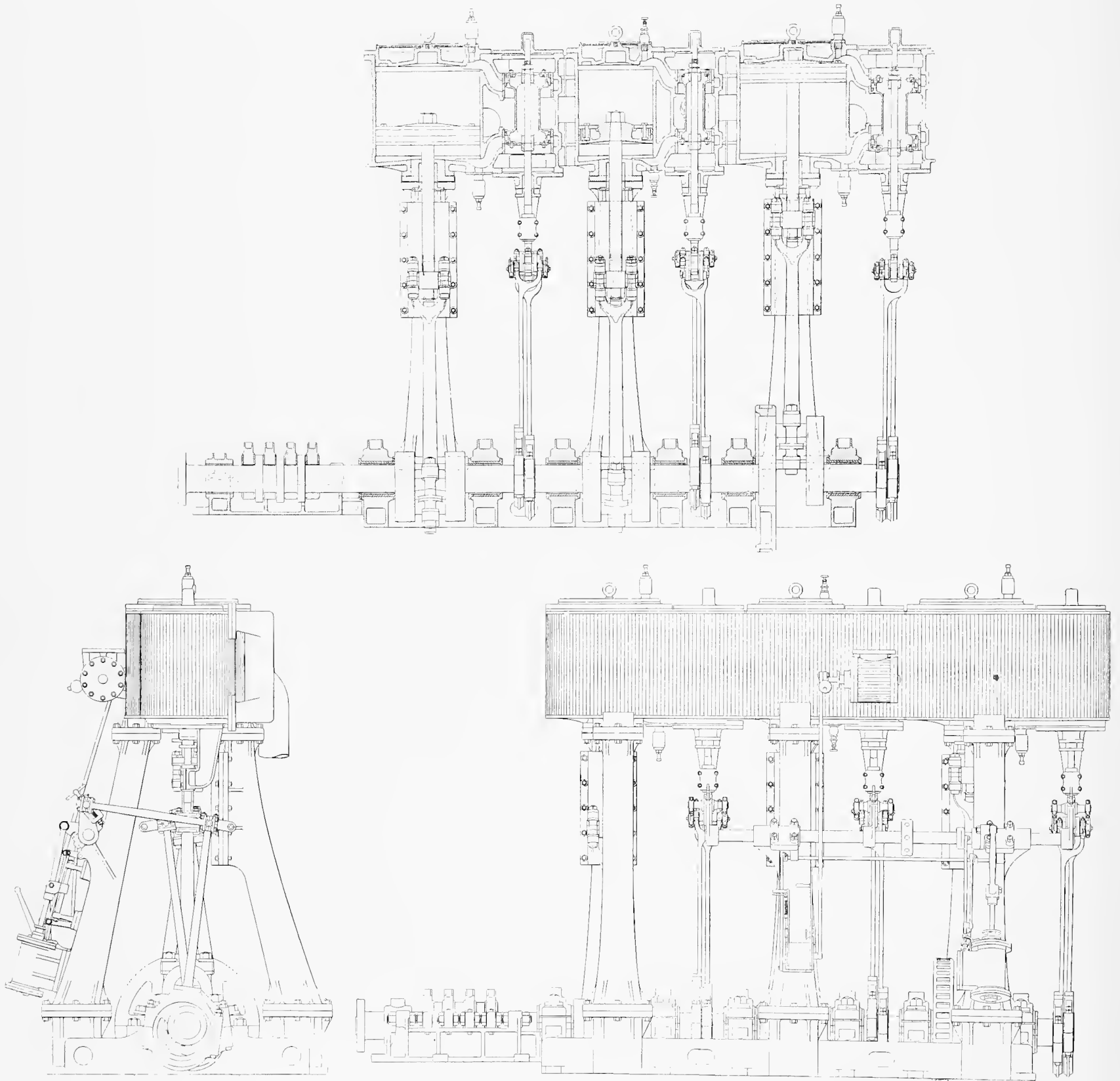

THREE CYLINDER COMPOUND ENGINES OF THE FERRY STEAMER PLEASURE.— Built by F. W. Wheeler & Co., West Bay City, Mich.

inch brass tubes 6 feet long. One of the feature of the boiler-room, which is commodious and well ventilated, is a Kirby hydraulic ash ejector, manufactured by the Detroit Dry Dock Company. By this labor-saving device the ashes are forced overboard by water under pressure from the deck pump. The principal dimensions of the vessel are: Length over all, 140 feet; length on load water line, 127 feet 4 inches; breadth over guards, 51 feet 6 inches; beam, moulded, 39 feet 7 inches; beam on load water line, 36 feet; depth, moulded, 14 feet 5 inches; draught aft, 12 feet; draught forward, 9 feet. The hull is built of white oak of very heavy dimensions throughout, and shaped forward so as to enable her to easily break through the ice encountered during winter service between the cities of Detroit and Windsor. The vessel has three decks, and is capable of accommodating 2,000 passengers. The designs of hull and machinery were made by the builder's constructing engineer, S. Anderson.

Donegan & Swift's Launch Engine.

This engine is very light in weight, and simple in its working parts and design. It is a single engine, with reversing lever, operated on the side. The smallest size, $2\frac{1}{2}$ horse-power, has a $2\frac{1}{2}$ inch cylinder; stroke, 3 inches; revolutions, 250; diameter of shaft, 1 3-16 inches; height, 22 inches; base, 12 by 12 inches; weight, 90 pounds. The largest size is 20 horse-power and of the following dimensions: Cylinder, $7\frac{1}{4}$ inches; stroke, 8 inches; revolutions, 200; diameter of shaft, 2 7-16 inches; height, 52 inches; base 26 by 30 inches; weight, 850 pounds. These engines are built by Donegan & Swift, New York.

Lumgair's Quadruple-Expansion Engine.

David Lumgair, of West Bay City, Mich., has two patents on a quadruple-expansion condensing engine, which, it is claimed, is suitable for the heaviest marine work. The principles can also be applied to the triple-expansion engine for those who prefer lower steam. The working of this engine will readily be understood by examination of the accompanying illustration. Steam from the boiler enters the high-pressure valve chest through opening *a*, and enters the lower end of the cylinder on the top side of the valve, leaving the cylinder through the bottom side of the valve. It then enters opening *b*, and passes through pipe *b* to the upper end of the valve chest, and enters the top end of the cylinder on the bottom side of the upper valve, leaving the cylinder through the top side of this valve, where it enters pipe *c*, leading to the second intermediate pressure valve chest. The steam enters this cylinder through the bottom side of the valve, and leaves on the top side of the valve; it then passes into the low-pressure valve chest, enters the valve on the top side, and exhausts through this valve into the condenser through opening *e*. The high-pressure, first mean pressure, and second mean pressure are piston valves; the low-pressure valve is a slide valve. The spaces between the two pistons on each engine are connected to the condenser. A live steam pipe, with valve connection, is placed under the valve on the first intermediate pressure.

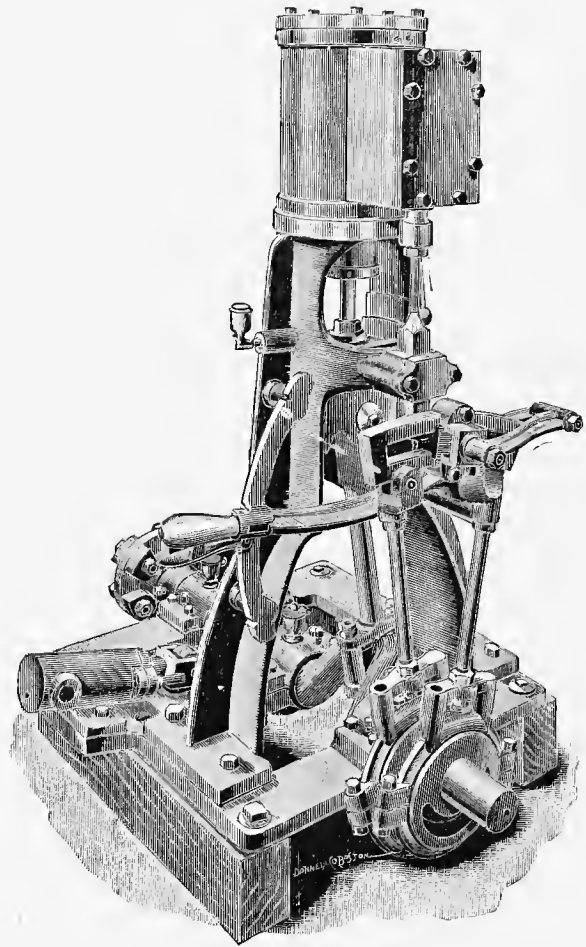

DONEGAN & SWIFT'S LAUNCH ENGINE.

There being always a vacuum between the two pistons, the difference in area of the two cylinders, multiplied by the vacuum, will give, in the small engines shown, 4 horse-power to the first two cylinders, and 16 horse-power for the other two cylinders, and equals the power gained by the vacuum. It was found that by opening the live steam connection with the upper valve on the high-pressure end, the engine could be forced in case of emergency. In trying it on a 12, 17 and 24-inch triple-expansion engine, 25 more turns a minute were made. The inventor, Mr. Lumgair, claims for these engines that they are easily handled and reverse well. They take up little room in the boat, there are only two sets of engines to look a'ter and the pistons are easy to get at. The first cost is low, and the fuel consumption is small. The following is a key to the letters shown on the drawing: Cylinders 6, $8\frac{1}{4}$, $11\frac{3}{4}$, $15\frac{3}{4}$ -inch by 10-inch stroke; *a*, steam from boiler; *b*, high-pressure to first intermediate; *c*, first mean to second mean pressure; *d*, between pistons to condenser; *e*, exhaust to condenser; $\frac{7}{8}$ -inch valve and connections, live steam to first mean pressure. Valve for reversing not shown in plan.

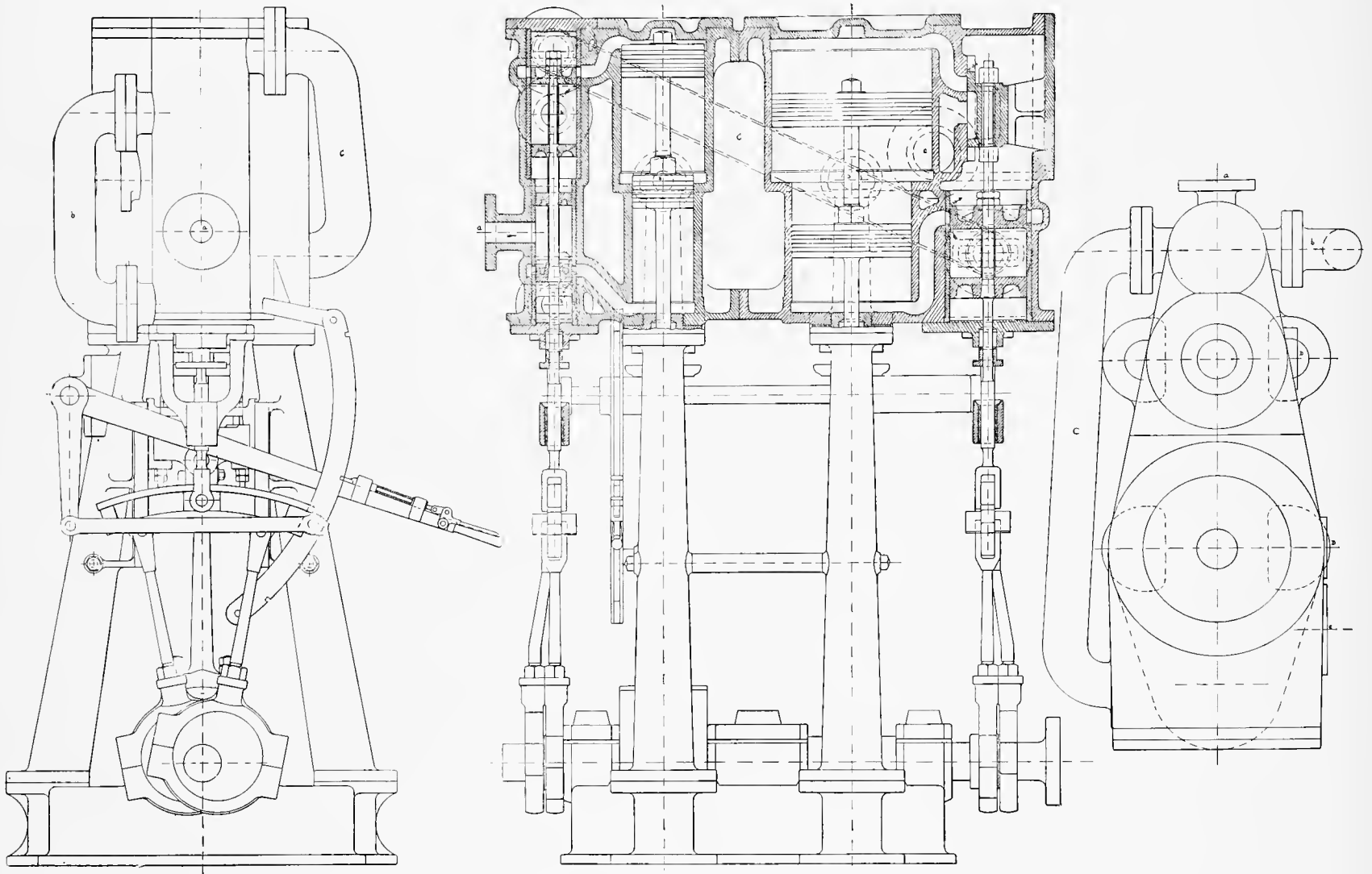

LUMGAIR'S PATENT QUADRUPLE-EXPANSION MARINE ENGINE.—Designed by David Lumgair, West Bay City, Mich.

Steeple Compound Engines of Ferryboat Cincinnati.

The motive power of the Cincinnati consists of two steeple compound engines, of which we give a perspective view. These engines were designed by H. S. Hayward, Superintendent of motive power, and H. Canfield, and constructed at the Pennsylvania Railroad Company's shops at Hoboken, N. J. The high-pressure cylinder of each engine is 18 inches diameter; low-pressure cylinder, 36 inches diameter; stroke, 26 inches. A distinguishing feature of these engines is the balanced piston valve, which is the invention of Hobart Canfield, Master Mechanic in charge of the Pennsylvania Railroad shops at Hoboken. Fig. 3 shows this valve on a larger scale, and its action will be readily understood. One valve is used for both cylinders. When the pistons are at the upper end of the stroke, the valve occupies the position as shown in Fig. 3,

allowing the steam from the lower part of the steam chest to pass through the upper port of the high-pressure cylinder as indicated by the arrows 1; while the exhaust steam from the high-pressure cylinder passes through the lower port, as indicated by the arrows 2, into the valve, which is cast hollow, and leads the steam into the upper part of the low-pressure cylinder, as indicated by arrows 3; the exhaust from the low-pressure cylinder passes through the lower port into the upper part of the chest, as indicated by arrows 4, from whence it flows through the exhaust pipes into the condenser. The advantage obtained with the use of this valve is that, during the passage of the steam from the high-pressure to the low-pressure cylinder, condensation is reduced, and a comparatively high pressure is secured in the low-pressure cylinder. The weight of the valve stem and tail-rod is such as to counterbalance the difference in pressure on the upper and lower ends of the valve.

Its construction is certainly very simple, and it gives excellent results. In these engines the valves are actuated by a Joy gear, but they may be operated by any of the usual motions. The main shafts are coupled between the two engines, so that, in case of an accident to either engine or line of shafting, they can be disconnected and used independently. The shafts extend the entire length of the boat, with a four-bladed

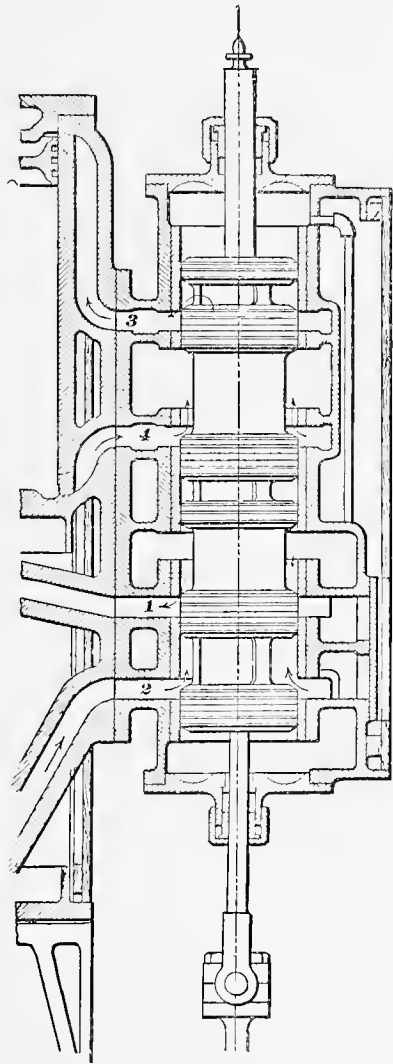
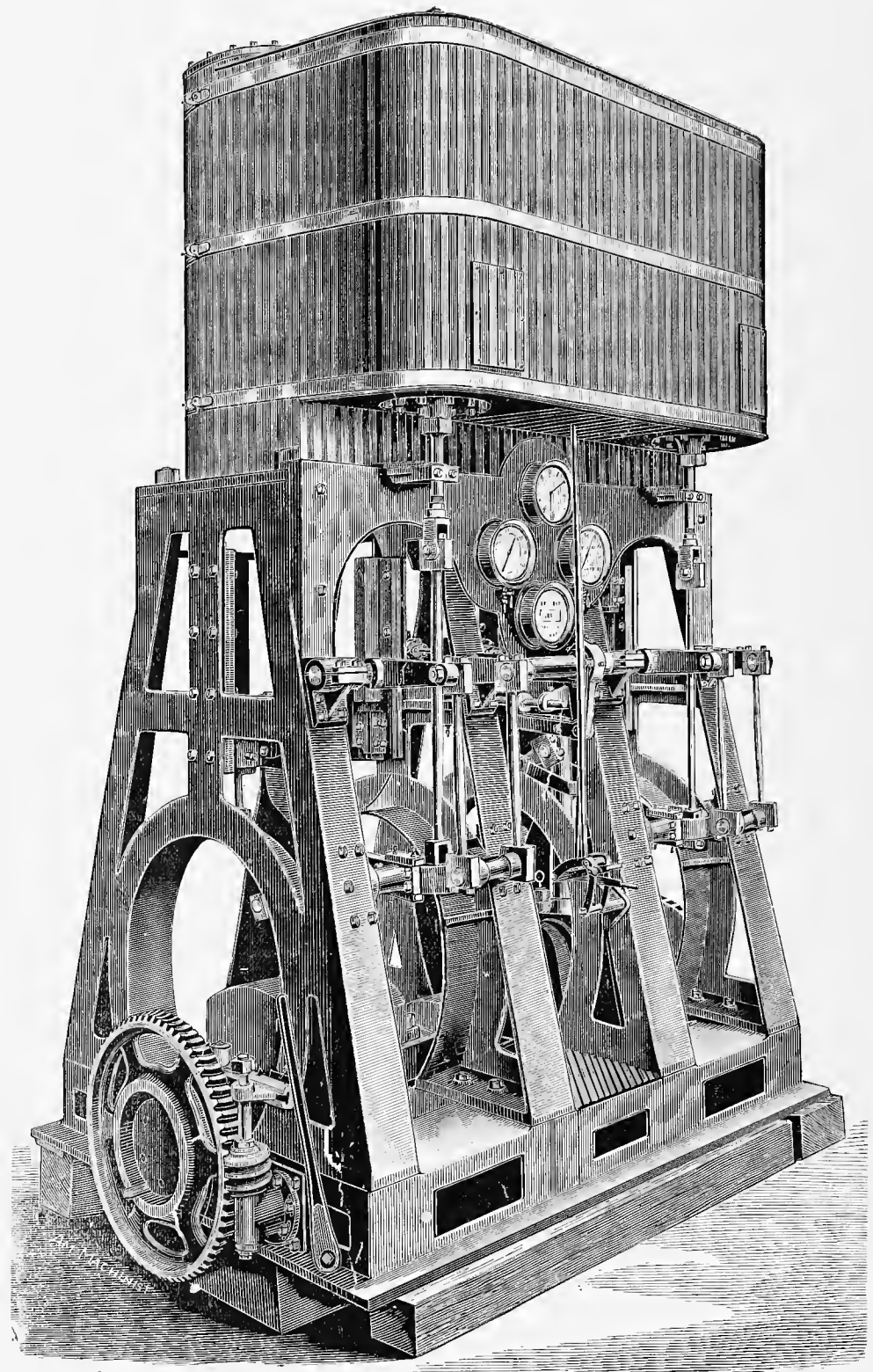

FIG. 3.—CANFIELD'S BALANCE VALVE.

sectional propeller wheel at each end; these wheels are 8 feet 9 inches diameter, and 13 feet 6 inches pitch, and work together in either direction. The diameter of shaft is 9 inches; diameter of crank pin, $8\frac{1}{2}$ inches; length, $9\frac{1}{2}$ inches. High-pressure piston-rod is 4 inches diameter, and low-pressure piston-rod is 3 inches diameter.

The condensing apparatus is independent of the main engines. The condenser is cylindrical, 4 feet 6 inches diameter, 12 feet 3 inches long, and has 1,950 square feet cooling surface.



STEEPLE COMPOUND ENGINES OF FERRYBOAT CINCINNATI.

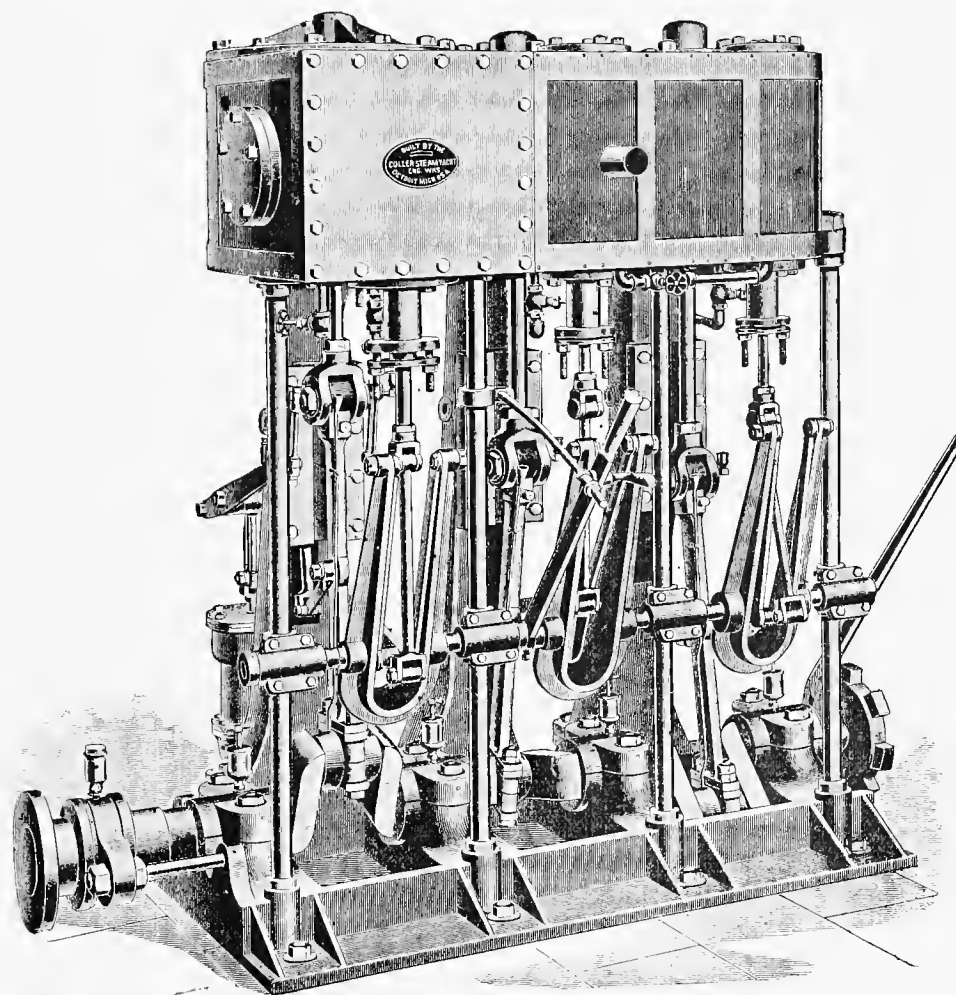

THE COLLIER YACHT ENGINE.—Designed by B. J. Collier, Detroit, Mich.

The cooling water passes through the tubes and is provided by a 10-inch centrifugal pump, driven at 230 revolutions per minute, by a 7 by 7 vertical engine. The air-pump is of the Knowles pattern, with 10-inch steam cylinder, 12-inch air-cylinder and 16-inch stroke. Steam is furnished by two return tubular flue boilers, 10 feet diameter, 16 inches long. Each boiler has two furnaces, 42 inches diameter, giving 49 square feet grate surface and 1,750 square feet heating surface, and is tested for a working pressure of 120 pounds. One of the economical features in the design of a ferryboat for this service is that it is wasteful to have the boiler power equal to that of the engine, as over one-half of the boat's time is spent in the ferry slips. As the engines are idle so long, loss in the boiler pressure while crossing the river is desirable; so that with nearly uniform firing the boilers will not "blow off" while waiting in the ferry slips. On the test trips that were made, a uniform boiler pressure of 97 pounds was maintained for two hours; the main engines made 92 revolutions per minute and developed 720 indicated horse-power which gave a speed of

12.25 miles per hour. When the boat was stopped and the steam pressure allowed to reach 115 pounds, the engines showed 1,016 indicated horse power and two miles were made in eight minutes, or at an average rate of 15 miles per hour; the steam pressure at the end of this run had fallen to 88 pounds. The tests showed that the boilers burned 15.85 pounds of coal per square foot of grate per hour and had evaporated 9.72 pounds of water to one pound of coal. There is, in addition to the main boilers, a donkey boiler 42 inches in diameter and 6 feet 9 inches in height; a Craig circulating apparatus is fitted in connection with this boiler, by which a uniform temperature is maintained throughout the main boilers while steam is being raised. The principal dimensions of the hull are as follows: Length over guards, 206 feet; length of hull, 200 feet; beam over guards, 65 feet; beam of hull, 46 feet; depth from deck to keel, 17 feet; draft, 10 feet 10 inches; displacement, 890 tons. The hull is of iron, built by Samuel L. Moore & Sons Co., of Elizabethport, N. J., from plans and specifications furnished by the Pennsylvania Railroad.

The Collier Yacht Engine.

This engine was designed by B. J. Collier, of Detroit, Mich., and is built by the Collier Steam Yacht and Engine Works, of that city. By close examination of the engraving, it will be seen that the Collier patent valve motion to this engine is taken from the connecting-rod, which results in a quicker opening of the valve than that of any other engine. These engines are built in sizes from 30 horse-power compound to 600 horse-power triple-expansion.

See's Quadruple-Expansion Engine in Tug El Toro.

The Morgan Line steel tug El Toro (the Bull), constructed by the Newport News Shipbuilding and Dry Dock Company in 1891, from specifications of Horace See, New York, is one of the most complete vessels of her kind in the United States. The El Toro was designed principally as a fire boat, to be stationed at Pier 37, North River, and to tow the ships of the Morgan Line from that pier, where they go upon their arrival in port to discharge cargo, to Pier 25, North River, the lower berth, where the vessels are loaded.

The dimensions of the El Toro are as follows: Length over all, 90 feet; beam, moulded, 19 feet; depth, 10 feet 9 inches. Her tonnage is 65.8 net and 130.16 gross. The main engine is of the vertical surface condensing quadruple-expansion type, with two cranks working at right angles to one another, two pistons being connected and arranged tandem to each other. The cylinders are $9\frac{3}{4}$, $13\frac{1}{2}$, $18\frac{3}{4}$ and 26 inches diameter, respectively, with 22 inches stroke of piston. Steam of 180 pounds pressure is employed. The lower cylinders are bolted together, and supported on one side by two columns, which are cast on the condenser, and on the other side by two wrought-iron columns fastened to the bedplate. The cast columns also form the guides, which are of the slipper slide variety, with water circulation through the go-ahead face. The front of the engine is open for examination of the journals. The upper cylinders are bolted together, each one being supported on three columns secured to the lower cylinders. All of the cylinders are fitted with piston slide valves, operated by the See-Marshall valve gear, and reversed by steam gear from the upper platform. All of the main steam piston and valve-rods are fitted with the See metallic packing. The condenser is fitted with brass tubes and sheets. An independent centrifugal circulating-pump supplies the condensing water. The air-pump is driven from the crosshead, as are also the feed and bilge-pumps. There are also two Worthington independent vertical feed, fire and bilge-pumps, arranged either for feed, fire or bilge service. The circulating-pump is also provided with a bilge suction for pumping out the boat. A Wass extractor is furnished to remove grease, air, etc., from the feed-water. The propeller shaft is covered with brass at the water end, which revolves on a lignum-vitæ bearing; the wheel is a solid true screw of iron, 7 feet in diameter. The boiler is of steel and of the cylindrical return tubular type, fitted with two corrugated furnaces leading into one common combustion chamber. It is $9\frac{1}{2}$ feet diameter by $10\frac{1}{2}$ feet long, and was built by Hammond & Coon, Buffalo, N. Y.

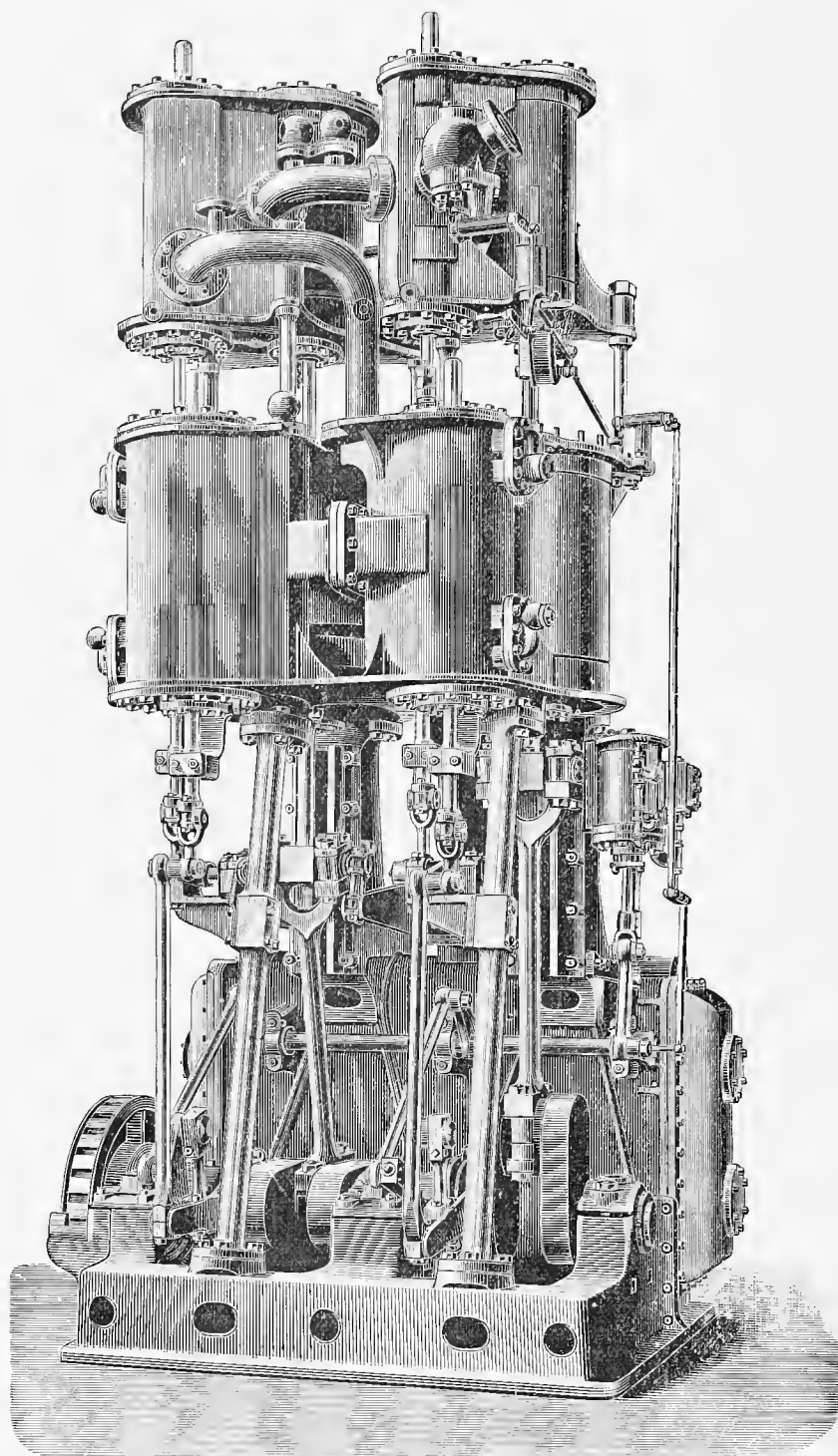

SEE'S QUADRUPLE-EXPANSION ENGINES IN TUG EL TORO.

HOWELL'S STEAM VESSELS AND MARINE ENGINES.

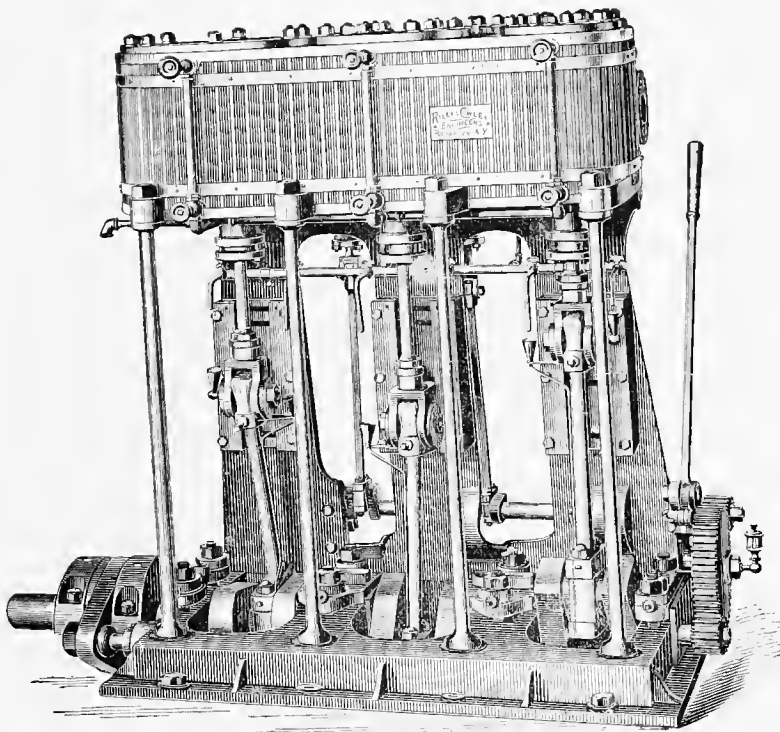

5, 8, 13 1/2, by 8.

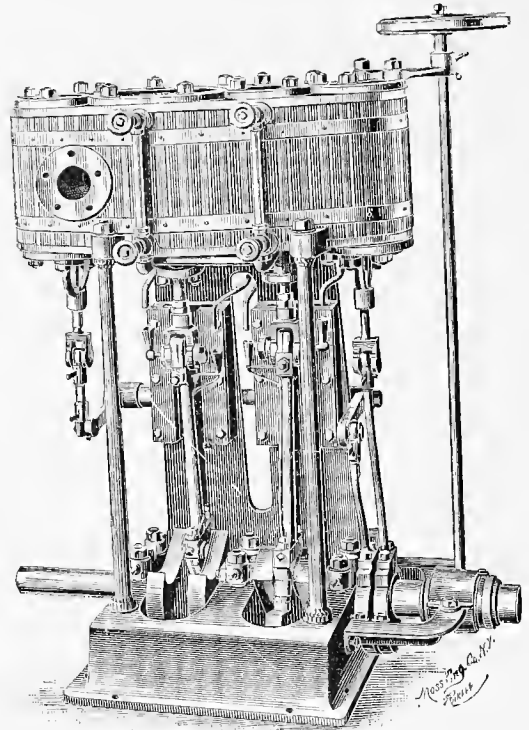

4 1/2, 9 by 6.

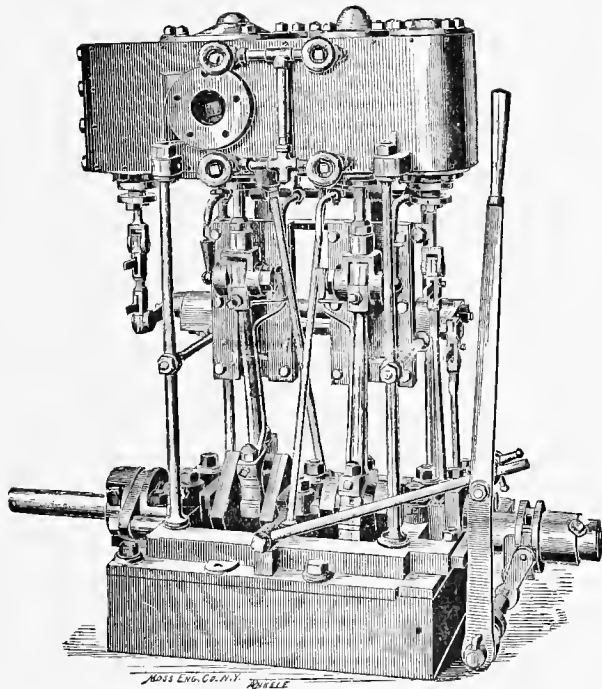

3, 5 by 5.

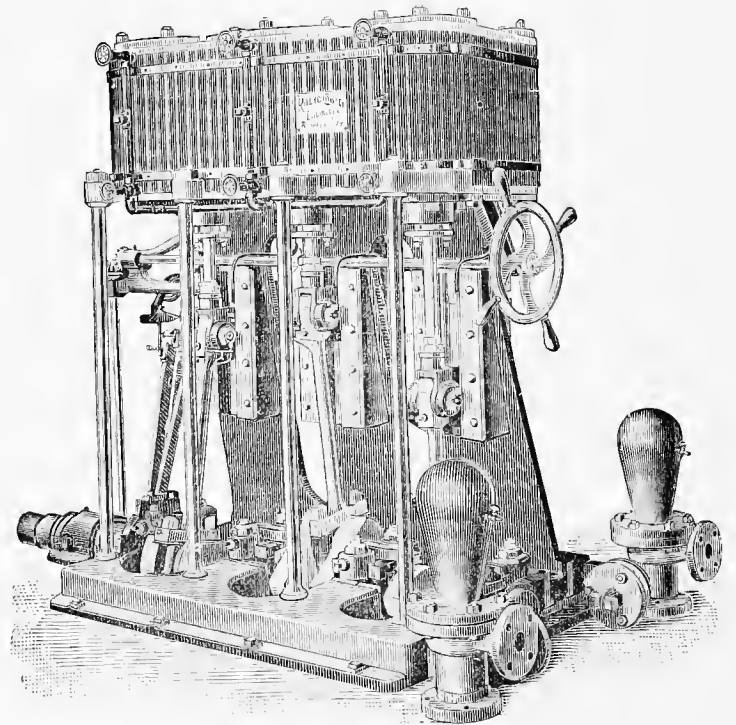

5 1/2, 10, 16 by 10.

RILEY & COWLEY'S STEAM YACHT AND LAUNCH ENGINES.

Riley & Cowley's Launch and Yacht Engines.

The small cut represents Riley & Cowley's $4\frac{1}{2}$ and 9 by 6-inch compound launch engine. The valves are of the piston type. The cranks are at right angles, thus avoiding any "dead centres." Reversing is effected by means of an improved gear, consisting of one eccentric for each valve keyed upon a loose sleeve placed on forward end of shaft. Loose sleeve is rotated about on shaft in either direction by means of a pin engaging in a spiral in sleeve and straight spline in shaft, said pin being moved forward and aft on shaft by a second sleeve operated by rack and pinion. A pass-over valve introduces live steam into the low-pressure valve chest when it is desired. The engine is provided with a complete automatic oiling apparatus, whereby

complete and stored away for winter. Great economy in fuel and ease of handling make it most desirable for small yachts, while its handsome appearance makes it an ornament to the yacht. This size of engine, with 250 pounds steam pressure and 600 revolutions, will develop 50 horse-power, and is suitable for boats from 40 to 50 feet long. These engines are built by Riley & Cowley, South Brooklyn, N. Y.

This firm was called upon in 1891 to build a fast steam launch for the Yale Navy, so-called, the same being the Yale College Boat Club. This launch is to follow the regattas, or races, between rival colleges, and must necessarily be fast and handy to keep up with the contestants. The committee tried other builders before Riley & Cowley, but the vessels supplied were not accepted, as they did not come up to the requirements.

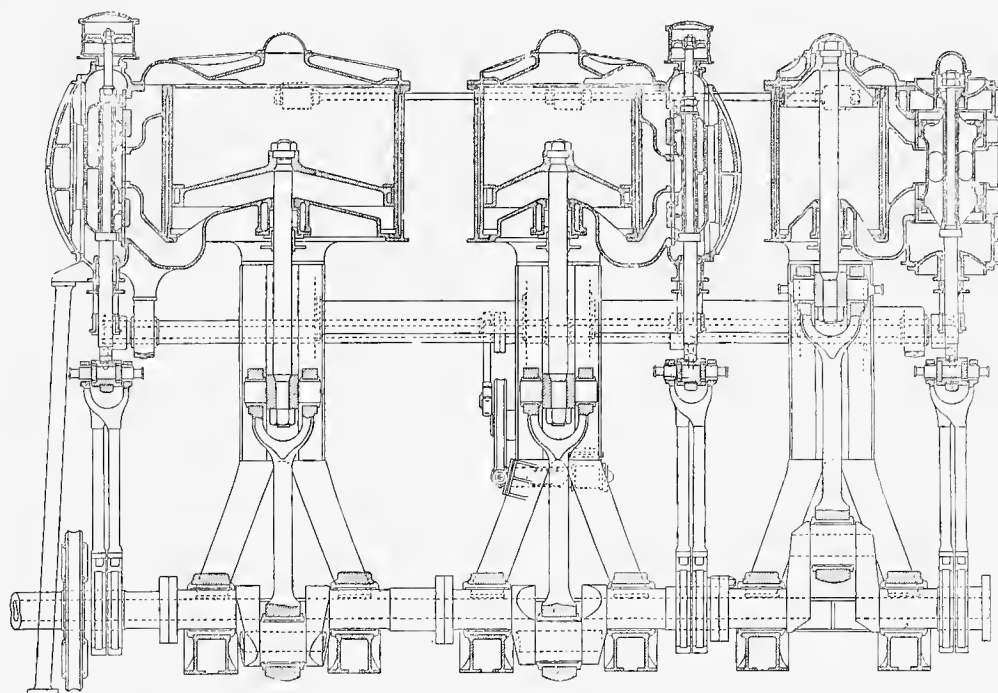

LONGITUDINAL SECTION THROUGH SET OF TRIPLE-EXPANSION ENGINES.

From "STEAM AND THE MARINE ENGINE."—By John Yeo.

all journals are uniformly lubricated with running at highest speed. Adjustments for taking up the lost motion on every working joint of the engine are also provided, and the bearing surfaces are of ample area. It will be remarked that the engine presents a very open front, enabling attendant to adjust and inspect working parts at all times with facility, and allowing of repairs to be made without pulling engine apart. One of the marked features of these engines is the entire absence of vibration, even at highest speeds. This is due to the care with which the reciprocating parts are balanced. The ports and passages are so proportioned that excessive speeds are possible without undue frictional resistance to steam in passing through them. The engine, being free from pumps, delivers its full power to the propeller, while the pumps, being independent, may be adjusted to their work. It is self-contained and of exceeding light weight, and may be readily lifted out of boat

This firm had no difficulty in constructing a launch to fill the bill, which was to make a boat capable of a mean velocity of 14 miles an hour for seven continuous hours. They did this, as stated, and ran a measured mile in slack water in 3 minutes 15 seconds, which is at the rate of $16\frac{1}{2}$ miles an hour. The details of the launch are as given herewith :

The hull is 53 feet long over all, 8 feet 6 inches beam, by 4 feet deep ; she is an open launch, having a cockpit fore and aft, with a car-top canopy over engine and boiler, and curtains to enclose the machinery. The engines are the Riley & Cowley triple-expansion type, 5, 8 and $13\frac{1}{2}$ by 8 inches. The piston valves are on the side, so as to economize space fore and aft. The valve motion consists of three gears ; one is keyed on the crank shaft, one on a three-throw crank shaft (cranks coincident with main crank shaft), and one large gear on a movable stud to raise the wheel above or below centre line, so as to give

angular advance to valves for forward or back motion. The improved reversing gear of this engine was suggested by Charles R. Cowley, son of the senior member of the firm, and is the first of the kind ever used. It marks a new departure in this branch of marine and mechanical engineering. No links or eccentrics are used, as the valves are driven by a small three-throw steel crank shaft, which derives its motion from the main crank shaft by means of three cut-gear wheels.

The intermediate wheel is provided with a sliding mechanism whereby it may be moved along a line at right angles to a line connecting the two shafts.

Paul's Patent Reversing Gear.

With this gear the motion of the engine is reversed by shifting the eccentric centre across the shaft in a direction at right angles to the crank, from the ahead to the astern centre by the means shown in sketch. The shaft end is flattened, and the eccentric eye fitted to it with sufficient clearance at the sides to allow the necessary travel across the shaft. It is also bored out to fit a mandril, which, revolving with the shaft, is shifted out or in by means of the ordinary reversing lever or wheel and screw gear. This mandril is fitted at the inner end with

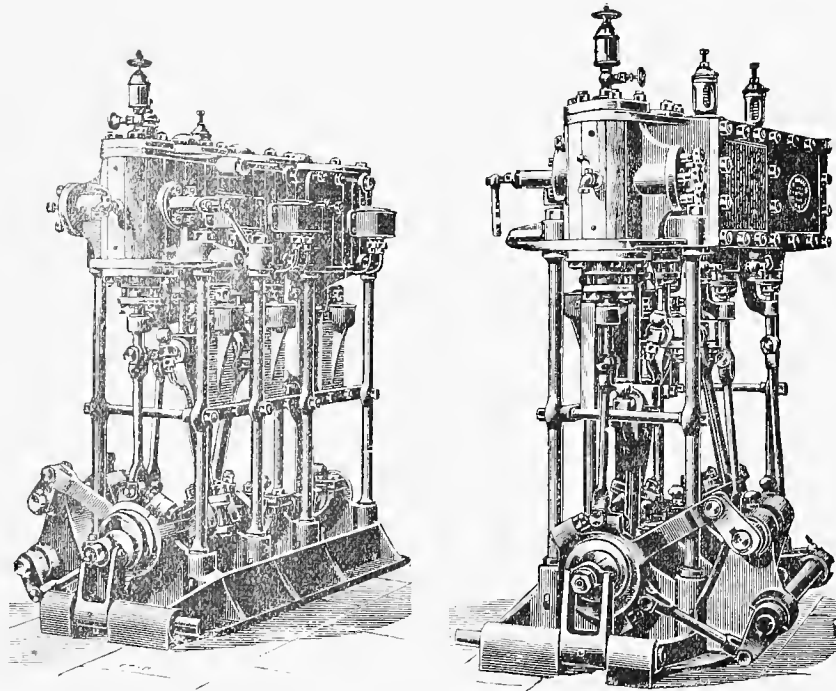

Paul's Patent Eccentric Single Valve Gear, equal to Link Motion.

This motion gives the proper angular advance to the valves and determines the direction in which the engine will run. From the crank pins of the valve crank shaft are connecting-rods attached to the valve stems. The piston valves are fitted with rings and the seats are bushed with steel. The cross-heads, valve stems, and piston-rods are also steel. The crank shaft boxes are of the best composition, and the propeller shaft is of Tobin bronze; it is $2\frac{1}{2}$ inches diameter, and the propeller itself is 36 inches diameter, by 5 feet pitch.

The boiler is the Roberts water-tube type, having 16 square feet of grate surface. The condenser is copper, of the keel type, and all pipes are of copper and brass. Under the floor forward is a copper tank that contains 150 gallons fresh water. The certificate allows 250 pounds of steam.

a steel pin, which projects through longitudinal slots in the shaft into diagonal slots in the eccentric. The pressure of this pin on the sides of the diagonal slots, as the mandril is moved out or in, causes the eccentric to move across the shaft. The eccentric is prevented moving endways on the shaft by a collar and washer. The valves of two cylinders working on cranks at right angles are actuated from one eccentric by the arrangement shown in dotted lines. The valve immediately over the eccentric is worked direct, while the other valve, which may be placed on centre line of cylinders, or out to front or back, is worked through weigh shaft and wipers, the motion for these being taken off the strap at right angles to the eye for the direct wrought valve. For three or more valves the motion is taken from the strap at points corresponding to the position

of the cranks, with separate weigh shaft and wipers for each valve. The special point about this gear is that it has the properties of variable cut-off and uniform lead as perfect as in the best link motion arrangement, the eccentric travel and valve opening being varied, while the lap and lead remain constant. Matthew Paul & Co., of Dumbarton, Scotland, are the owners of this patent gear.

Compound Engines of the Hoboken Ferryboat Bremen.

The Hoboken Ferry was the first ferry in the United States to adopt the screw ferryboat. These boats are propelled by a screw at each end of the hull, one screw pushing and the

illustrations. They were built by the North River Iron Works. The high-pressure cylinders are 20 inches diameter; low-pressure cylinders, 36 inches diameter; stroke, 28 inches. Each boat is provided with an independent air and circulating-pumping engine of the Blake system, with compound steam cylinders similar in general design to those furnished for the United States battleship Maine. They are of the following dimensions: High-pressure cylinder, 7 inches diameter; low-pressure cylinder, 14 inches diameter; stroke, 16 inches. These work two single-acting vertical air-pumps 17½ inches diameter, and 14 inches stroke. One double-acting horizontal circulating-water cylinder, 17 inches diameter, 16 inches stroke. The seats for the salt water valves in the circulating-pump are

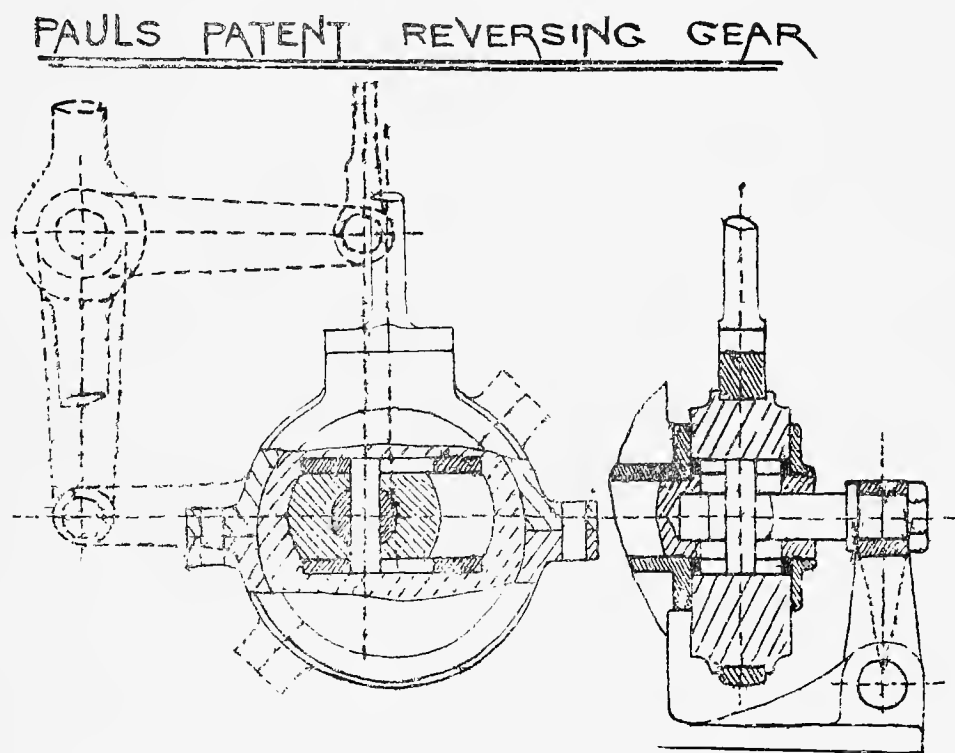

other pulling, as it were. This principle was first applied here to the Bergen, whose engines are, however, of the triple-expansion type. A continuous shaft runs the entire length of the boat, and is driven by one engine. If the shafts were in two pieces, and not connected, each screw would, of course, have to be run by an independent engine. The Bremen and the Hamburg are sister boats. Their hulls (steel) were built by T. S. Marvel & Co., Newburg, N. Y., and the machinery by the W. & A. Fletcher Company, Hoboken, N. J., in 1892. The length of each over all is 222 feet; on water line, 218 feet 6 inches; breadth over all, 62 feet; breadth on water line, 35 feet; draught, light, 10 feet 6 inches; draught, loaded, about 11 feet; depth of hold, 17 feet. The total seating capacity in each boat will accommodate about 450 persons. Each boat has two compound engines, as shown in the

formed in solid composition plates, instead of seats driven into cast iron. The piston and piston-rods are of composition, and the air and water cylinders are lined with composition. The extra amount of valve area permits the pumps to be run at a high rate of speed. The initial steam pressure in the main engines will be 125 pounds, furnished from two horizontal boilers, 9 feet 1 inch in diameter, and 21 feet long. Each has two corrugated furnaces, 44 inches diameter. Total grate surface, 100 square feet. The boilers are tested to 250 pounds hydrostatic pressure. The diameter of the crank shaft is 9½ inches. The cranks in each engine are set opposite to each other, and when the engines are coupled, the center line of cranks in one engine will be perpendicular to that of the other, so that the cranks practically stand at 90 degrees apart. The W. & A. Fletcher Company were the contractors for the entire boat complete.

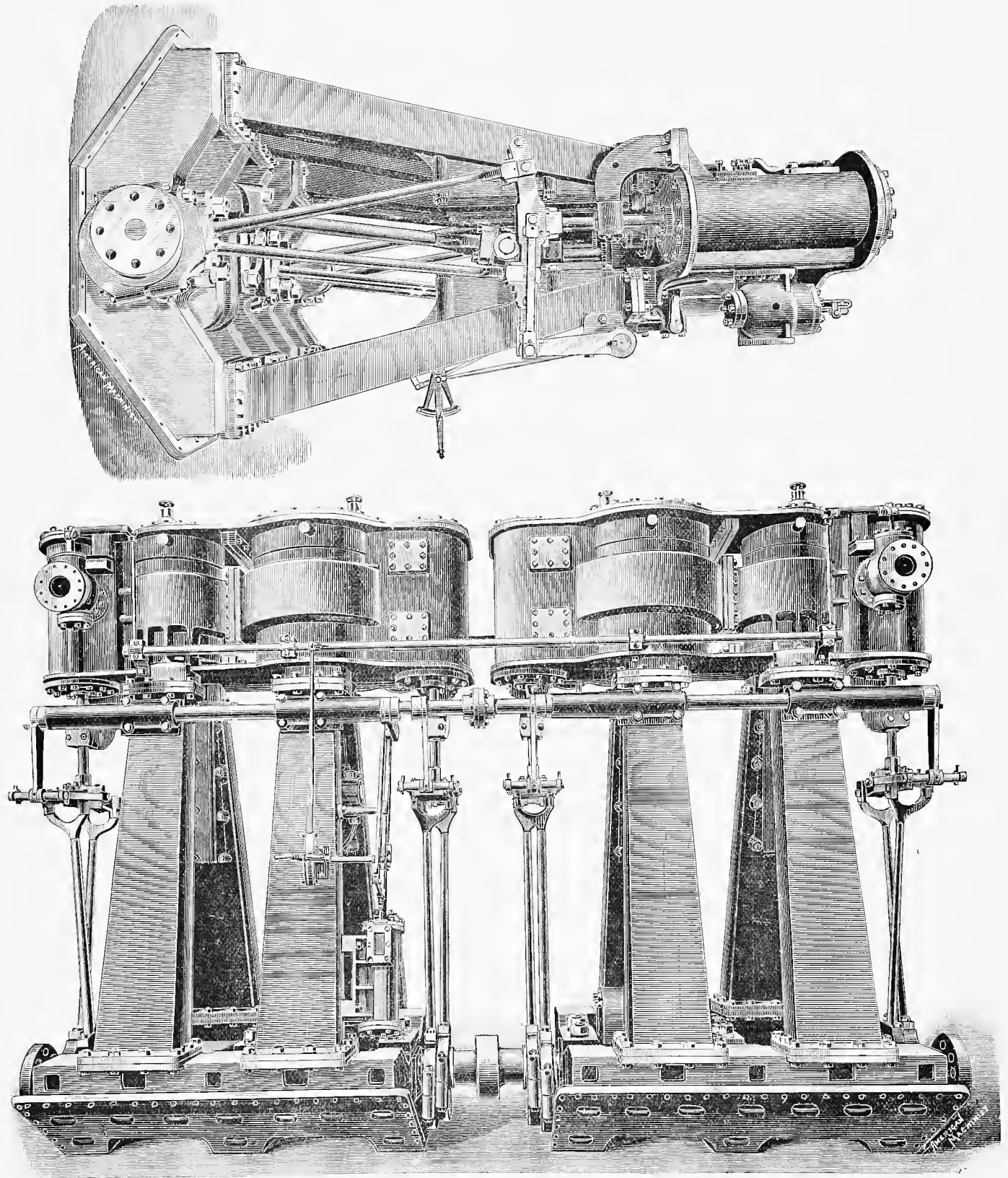

COMPOUND ENGINES OF HOBOKEN FERRYBOAT BREMEN.

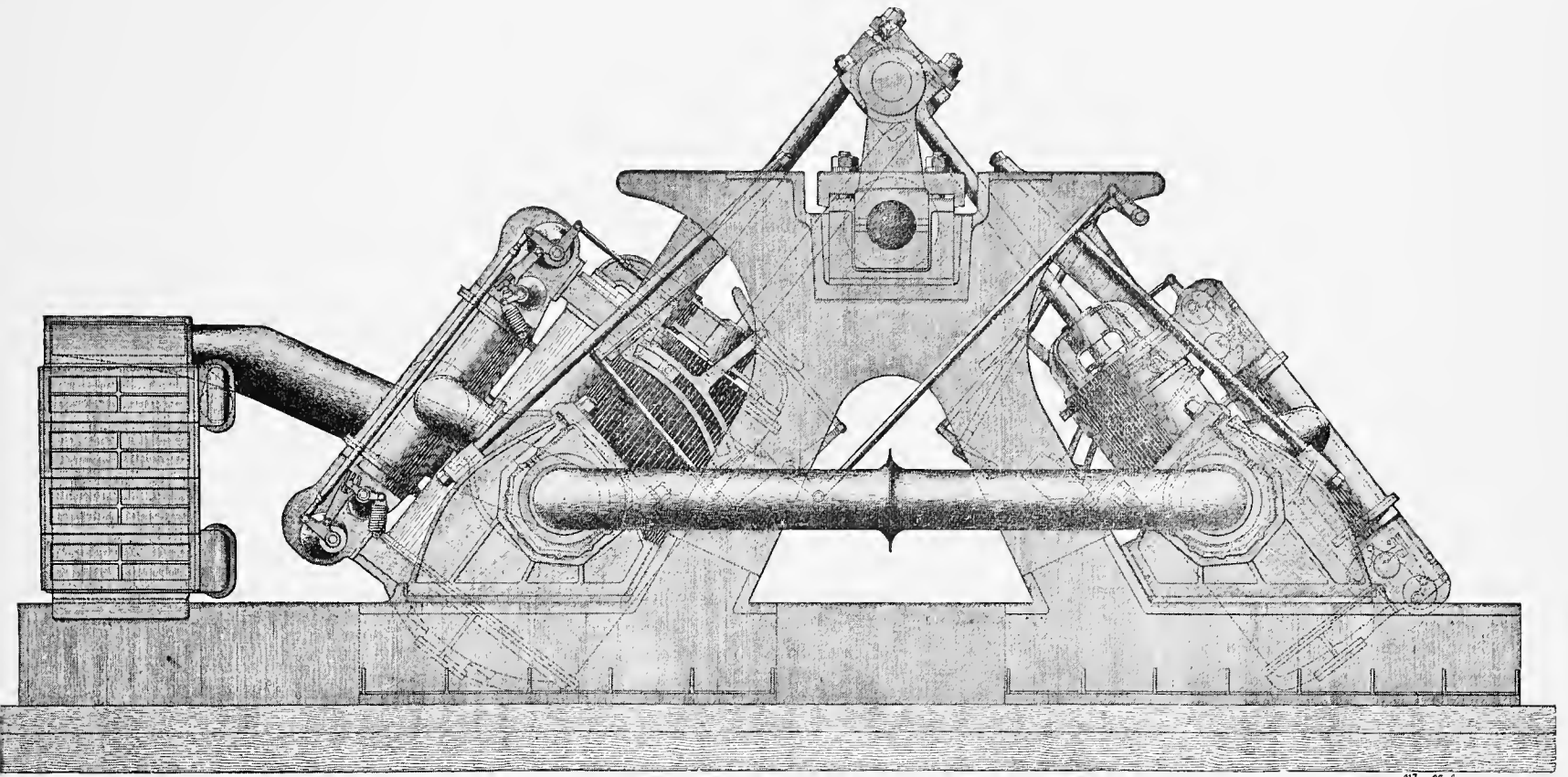

COMPOUND OSCILLATING ENGINE OF THE PROVIDENCE AND STONINGTON LINE STEAMER CONNECTICUT. —Built by Wm. Cramp & Sons, Philadelphia, Pa.

Oscillating Engines of the Connecticut.

The Providence and Stonington Line, through the persistency of the late Capt. David S. Babcock, several years ago decided to try a compound oscillating engine in its new freight steamer *Nashua*, and with that end in view contracted with the Morgan Iron Works for the engine which now propels that boat, the hull of which, as well as that of the *Connecticut*, were built by Robert Palmer & Son, Noank, Conn. After the engine was built, it was found that the modified Corliss valve gear with which it was fitted caused considerable trouble and anxiety, until Jerome Wheelock, of Worcester, Mass., put in the Wheelock gear, after which the engine worked like a clock. The *Connecticut* was designed by Geo. B. Mallory, New York, and her machinery was constructed by Wm. Cramp & Sons. The engine has a high-pressure cylinder $56\frac{1}{2}$ inches diameter and low-pressure cylinder 104 inches diameter, both being 11 feet stroke, and both coupled directly to the main shaft. This shaft carries feathering paddle-wheels, which were originally 28 feet in diameter, and had 12 buckets 14 feet wide and $4\frac{1}{2}$ feet deep. The steam pressure ordinarily carried is 120 pounds. Steam is furnished by six gunboat boilers, each $12\frac{1}{2}$ feet in diameter and 20 feet 3 inches long. These boilers are placed

three together and are fired from two fire-rooms; over each is located a centrifugal fan 6 feet diameter and 5 feet face, supplying 30,000 cubic feet of air per minute. The engines make about 25 revolutions per minute, and develop 4,500 to 5,000 horse-power; the speed which the boat can attain is 17 knots per hour. These engines are the largest oscillators ever built. The total weight of the engines and boilers, including the water in the latter, is about 1,000 tons. The surface condenser has 12,000 square feet of tube surface. All the auxiliary engines work in connection with a separate surface condenser entirely independent of the main condenser.

The direct-acting engine takes much less room than the beam engine, and also weighs considerably less than a beam engine of the same capacity. The *Connecticut* differs from her chief rival, the *Pilgrim*, in having a wooden instead of an iron hull. The design of her hull shows a bow line 171 feet long, or nearly half her length, then a short parallel body, and then stern lines sharper than those usually seen in other boats of this class. The principal dimensions are as follows: Length over all, 358 feet 6 inches; length on 11 feet load line, 345 feet; beam outside of hull planking, 48 feet 2 inches; extreme width over guards, 87 feet; depth of hold, 17 feet 3 inches; extreme depth forward, 23 feet 6 inches; extreme depth aft, 20 feet.

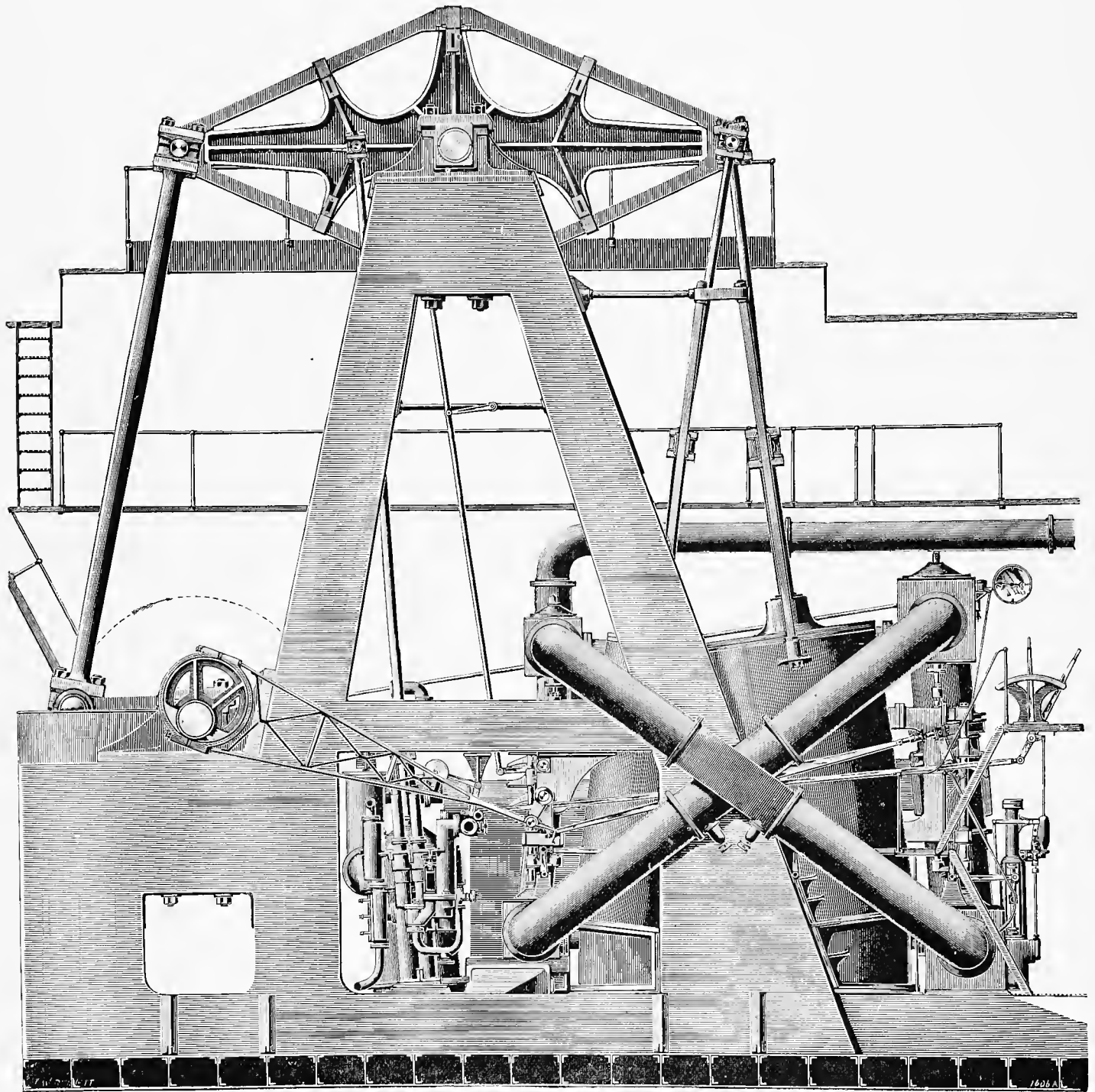

COMPOUND BEAM ENGINES OF STEAMER HONAM.—Built by A. & J. Inglis, Glasgow, Scotland.

Oscillating Engines.

This type is much more common in England than elsewhere. The term applies to a cylinder mounted on trunnions, oscillating on its axis to accommodate the lateral sweep of the crank, thus dispensing with a connecting-rod, crosshead and girders, the piston-rod being connected directly to the crank pin.

At first there was a persistent effort to perform steam distribution by means of, or through, the trunnions so as to dispense with valve gearing, thus reducing a piston steam engine to the most simple form it has ever attained, but these methods have failed in practice, and oscillating engines are now commonly made with the usual slide or other valves like fixed engines. The object sought in the oscillating type of engines, aside from simplicity and cheapness, was the saving of room, or their compactness, a feature conspicuous in English practice, where oscillating engines are in a great many cases set directly beneath the paddle shafts of steamers, and have given excellent service. This method is not only applied to small boats, but to large steamers of the highest class plying in the English and Irish Channels. The shortening of the stroke of engines, and various mechanical devices for diminishing the distance between the piston and crank has rendered the oscillating arrangement unnecessary. The rapid movement of the cylinders on the inward stroke of the piston produces lateral strains on the piston-rod, gland and pistons that cause rapid wear and derangement, unless provided for by careful design, good material and the best of workmanship. In fact, but one firm in the world has attained complete success with oscillating engines, that of Penn & Son, in England.—John Richards, in *Industry*, San Francisco, Cal.

Compound Beam Engines of the Honam.

The twin screw is displacing the single screw, and the paddle-wheel is giving place still more decidedly to the screw propeller; while in the method of operating the paddles the beam engine is destined soon to pass away. One finds several services which were formerly carried on by paddle steamers having beam engines now conducted by screw steamers. The Bergen, Bremen and Hamburg of the Hoboken ferry are cases in point, while several paddle steamers have now been fitted with other types of engines than that of which the walking beam was such an attractive feature. It is true, it required marvelously little attention; but it was far from economical. It can serve no purpose to sing a requiem—many of our American friends might claim that it is yet too soon for that. Certainly, in this country the beam engine belongs to the past. It never gained any distinct hold on British favor, although admired by Scott Russell, but several engines of the type have been made in this country for service in foreign waters, and a record of modern engineering practice would not be complete without a reproduction typical of the British design. A. & J. Inglis, of Glasgow, some years ago made probably the most successful engines of this class, and one is illustrated herewith. These we should have been glad to describe long ago; but characteristic modesty on the part of Messrs. Inglis suggested excuses as frequently as we urged the claims of our readers. The present time, however, is not

inopportune, since we may be said to be in the transition stage. Soon the triple-expansion direct-acting engine will be extensively adopted for paddle steamers, as it already is for screws.

It is not difficult to trace the evolution of the beam engine as applied to the propulsion of paddle steamers. The great difficulty in paddle engines was to get a sufficient length of stroke of piston, while keeping the engine low in the ship, and minimizing the length of space required. It was soon recognized by Watt, and some American engineers, that the most natural and possibly most picturesque arrangement was to adopt the simple old-fashioned beam used by Newcomen for the colliery pumps and land engines. While American engineers adopted this system, Robert Napier, Watt, Maudsley, and Fawcett continued to use the side-lever engine, the first named bringing it to its perfect stage in the Persia and Scotia. This side lever may be termed the English form of the beam marine engine. Here it was considered undesirable to obstruct the deck with the walking beam, while the adoption of the side lever enables the engineer to choose any proportion of stroke and any size of paddle-wheel that would best serve the purposes of the ship. American engineers have continued to use the beam engine, although, as we have indicated, there are evidences which encourage the belief that it will be superseded. Messrs. Inglis were the only firm in this country which largely adopted the system, and the engines of the Honam, which we illustrate, are a typical design. One of the largest beam engines constructed, however, was for the Puritan of the Fall River Line. The Inglis beam engine indicates several departures in the details when compared with the American engine of that day, and was more strongly built. The gallews frame, which supports the main center of beam, instead of being of wood, as was the usual practice in the United States, was of steel plates and angles, and of box section. It was secured to massive box keelsons on the floor of the ship. This style of framing had not then been adopted by any other firm, and it gave great satisfaction. The wooden frame used in the American engine "wobbled," and allowance had to be made for this in the clearance between the piston and cylinder ends, 5 inches being not uncommon. It is easy, therefore, to understand that there was considerable waste of steam and consequent loss of efficiency. The steel frame—which, by the way, is adopted in America—is perfectly rigid, and only the ordinary clearance is necessary. The Honam's engines were on the compound principle, and in this respect also were a departure. The cylinders, as shown on the front elevation, were inclined towards each other at the head, admitting of the piston-rods being connected to the one point on the forward end of the beam. This secured a perfectly balanced motion. In the engines of the Puritan, already referred to, the cylinders are nearly vertical, and are connected at two points to the walking beam. The great difference in the size of the two engines—the Puritan's indicate 7500 and the Honam's only 2900—mitigate against any reliable comparison of results, more especially as the former is worked under forced draught with Sturtevant fans, and has two superheaters utilizing the waste gases before they pass into the smokestack. It may be noted, however, that the indicated horse-power in the Puritan is at the rate of about 9 per square foot of grate area, while the power was 1 indicated horse-power to 3½ square feet of heating surface; in the Honam the results were 9.7 indicated horse-power to 1 square foot of grate area, and 1 indicated horse-

power to 2.73 square feet of heating surface. The relative coal consumption results would be interesting, but they are not given in the case of the Puritan. In the Inglis boats, fuel economy has always been a marked feature.

The high-pressure cylinder of the Honam's engines is 40 inches in diameter, with a stroke of 10 feet, while the low-pressure cylinder is 72 inches in diameter, with a stroke of 9 feet 10 inches, the difference in stroke being due to the inclination of the cylinders. Double-beat steam and exhaust valves are provided, while the high-pressure cylinder is fitted with expansion valves. The surface condenser is placed alongside the cylinders, as shown in the forward elevation, while the pumps are worked by a rod from the walking beam, as shown in the front elevation. The cooling surface is 5395 square feet. The walking beam, which is constructed in the same way as is usually adopted in American vessels, with cast-iron center and forged steel strap, is 23 feet in length, 11 feet deep, and weighs 14 tons. The section of beam strap is 7 inches by 9 inches, and the main center is 14 inches in diameter in the main bearings. The piston-rod is $5\frac{3}{4}$ inches in diameter in the case of the high-pressure, and 7 inches in that of the low-pressure engine, and of steel, while the connecting-rod is 23 feet long from center to center, and 13 inches in diameter. The crank shaft is $17\frac{1}{2}$ inches in diameter. The paddle-wheels have feathering floats, and are entirely of steel. They are 21 feet in diameter, and the floats are 15 feet by 4 feet. These latter measurements are very unusual, and it would certainly be very interesting to know if the builders of some of the recent fast paddle steamers have gone so far as to reduce the diameter of their wheels to 2.1 times the stroke, or to increase the float area to 60 square feet. Steam is supplied from three double-ended boilers placed athwartships and fired from the wings. These boilers are 14 feet in diameter and 14 feet long, and have in all 18 furnaces. The grate area is 297 square feet, and the heating surface 7939 square feet. They work at a pressure of 75 pounds, and at 33 revolutions the engines developed 2900 indicated horse-power. The steamer, which, with the engines working at this power, attained a speed of $16\frac{1}{4}$ knots, is 270 feet long, the breadth, moulded, being 38 feet, and the extreme breadth 72 feet 6 inches, the depth, moulded, 13 feet 3 inches, and the extreme 30 feet. The tonnage is 2800 tons.—*London Engineering*.

Stevenson Taylor, Vice-President and General Superintendent of the North River Iron Works, Hoboken, N. J., wrote to the editor of *Engineering*; under date of September 12, 1893, as follows:

SIR:—We are very much interested in your article "Beam Engines for Paddle Steamers" (issue of September 1, 1893), giving an account of the engine of the steamer Honam, as we were when you before published (November 9, 1888) a description of this same steamer. There are a few inaccuracies to which, in justice to our old friend, the beam engine, we must call your attention, and we believe you will be glad to correct them. 1. The wooden frames of the American beam engines never "wobbled" to the extent that "allowance had to be made for this in clearance between the pistons and cylinder ends;" and so far from "5-inch (clearance) being not uncommon," we must say that in our experience of over 40 years (during which time we have built and repaired hundreds of these engines) we have not seen one engine with 5-inch clearance; 1 inch at each end being the usual design for the largest of them. If there ever was a beam engine with 5-inch clearance at each

end or at both ends, it was because of an egregious blunder and not from necessity. 2. You refer in a complimentary manner to the iron frame and keelsons of the steamer Honam, parenthetically remarking, "which, by the way, is now being adopted in America." We have a number of boats on our list, as well as those built by others, built before the Honam, which have iron or steel engine frames and keelsons, and some of these boats have wooden hulls. 3. The Puritan has not forced draught. The blowers mentioned only ventilate the fire-room, which is so open that no extra air pressure is possible. No exact test for determining the economy of the Puritan engine has been made, but on the City of Fall River (a boat about the dimensions of the Honam), belonging to the same line, and having the same style of engine as the Puritan, careful tests were made in 1883 (see *Journal* of the Franklin Institute, July, 1884). These tests showed an average consumption of 2.04 pounds anthracite coal per hour per horse-power, and we have reason to believe that all of the engines built since, of the same style, perform just as well. The City of Fall River, by the way, has a wooden hull, with a wooden engine frame and keelsons, and both cylinders have a design clearance of 1 inch only. The engine frame does not "wobble." Of course, there is no use in these days advancing the advantages of the American beam engine. The tide is setting in other directions, but they have been, and still are, extremely serviceable, and, considered all round, are economical for work performed.

W. & A. FLETCHER COMPANY.

S. TAYLOR, *Vice-President and General Superintendent*.

Beam Engines.

These in theory and in fact represent the best arrangement for rotative speeds within their limit. Their special features are that the moving weights are in equilibrium, the pumps are worked direct from the beam, and the strains are more direct than in other engines. For these and other reasons they are more durable.

Their use on ferryboats in this country arises mainly from the fact that the machinery, as a whole, is set on its edge, so to speak, the main working parts above the deck, and the space occupied, a long, narrow strip fore and aft, does not interfere with the deck traffic and loads. It is true, the engine space extends up through the cabin and above the roof, but this is not a great encumbrance. There is also the reason for ferry service that beam engines fitted with balance puppet valves as made at this day are easy to "handle" and keep off the centers, because in equilibrium.

For stationary purposes there are the objections of greater first cost, larger proportions because of slower speed, larger space occupied, but, notwithstanding this, one of the finest plants for duty in cotton mills has just been constructed in England on the beam system, and the most complete pair of winding engines ever made on this coast are at this time (1895) under construction at the Union Iron Works in San Francisco.—John Richards, in *Industry*, San Francisco, Cal.

Setting the Valves of Beam Engines.

Assuming that the rock-shaft arm is keyed on to the rock shaft in its proper relation to the center line of motion of the eccentric-rod, and that the wipers are keyed on to the rock

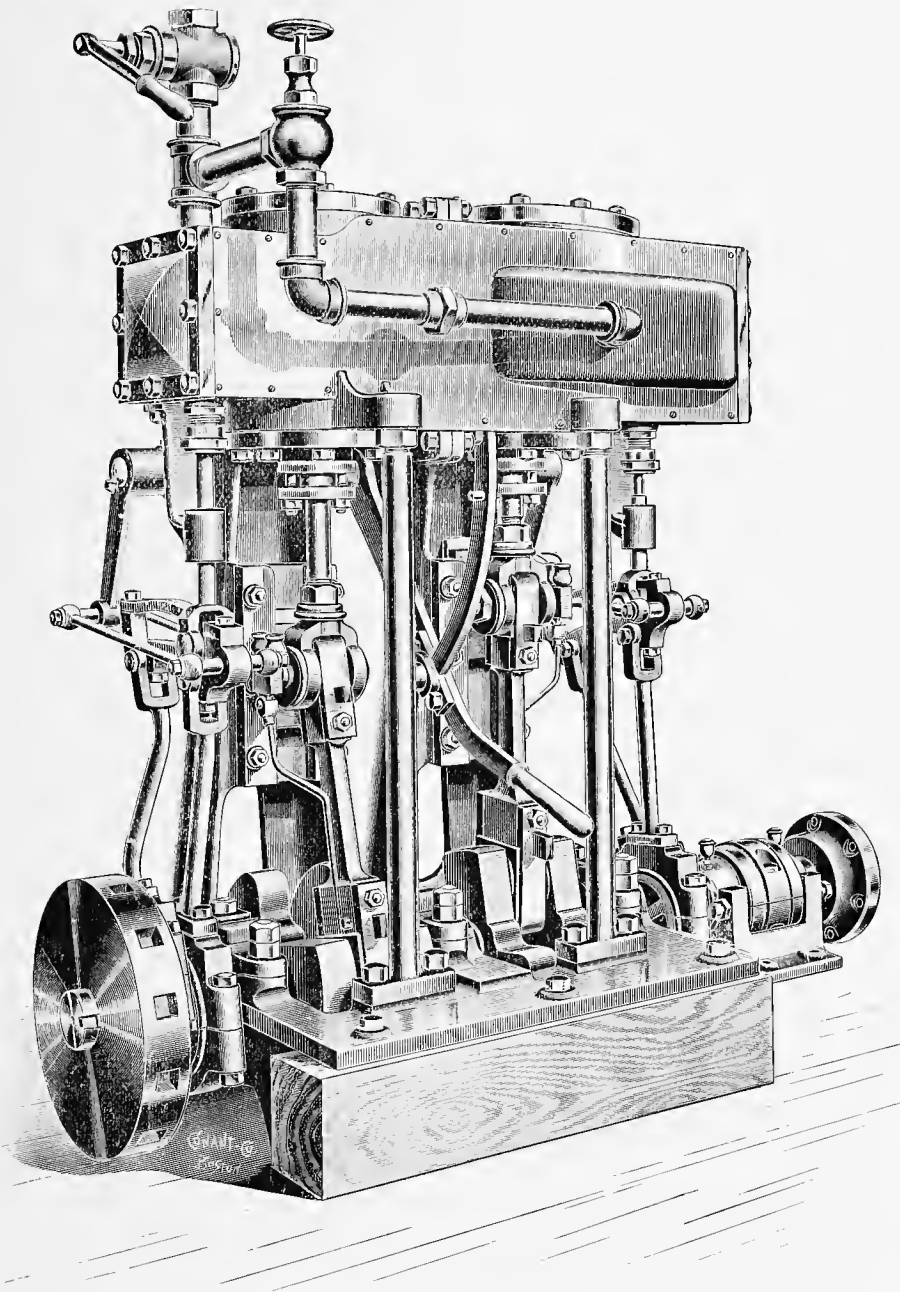

THE MORRIS COMPOUND MARINE ENGINE.—Built by the Morris Machine Works.

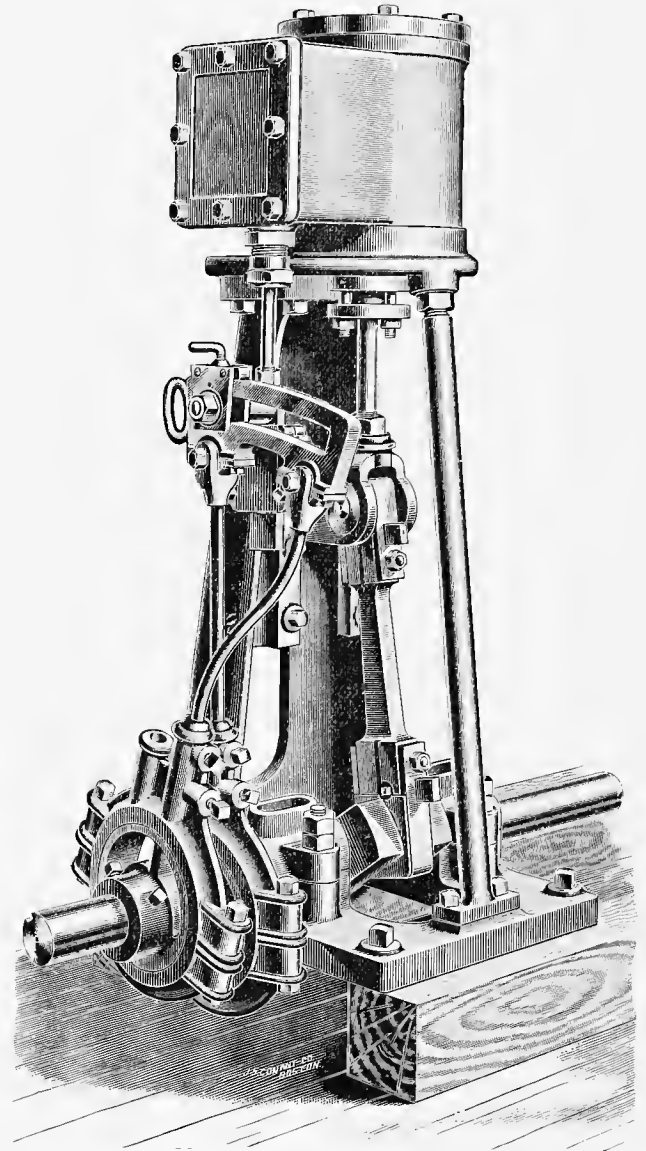

THE MORRIS SINGLE MARINE ENGINE.

shaft in their proper relation to the rock-shaft arm, which is always the case in properly constructed engines, the first step is to ascertain the proper length of the eccentric-rod, and the most convenient starting point for doing so is from the center of motion of the valve gear.

Hence, the first thing to be done in setting beam engine valves is to set and to hold the rock shaft at the center of its motion, which is when the lifting-rods are down, the valves seated, and the lifting-toes adjusted the right distance from the rock shaft, and straight with each other, so that the ends of both wipers will be the same distance from their respective toes.

Next put the main crank on the center, and turn the throw of the eccentric directly in line towards the center of the eccentric-hook pin; then make a fine center-punch mark on the edge of toe pin, and one on the edge of the hook strap, and set a pair of compasses corresponding to the distance between those marks, and measure it. Add to that distance half the throw of the eccentric; reset the compasses to that length, and move the eccentric until the eccentric punch marks and compasses again correspond, and adjust the length of eccentric-rod so that the hook will just engage the eccentric-hook pin while the eccentric is held at that position; then slack up the rock shaft so that

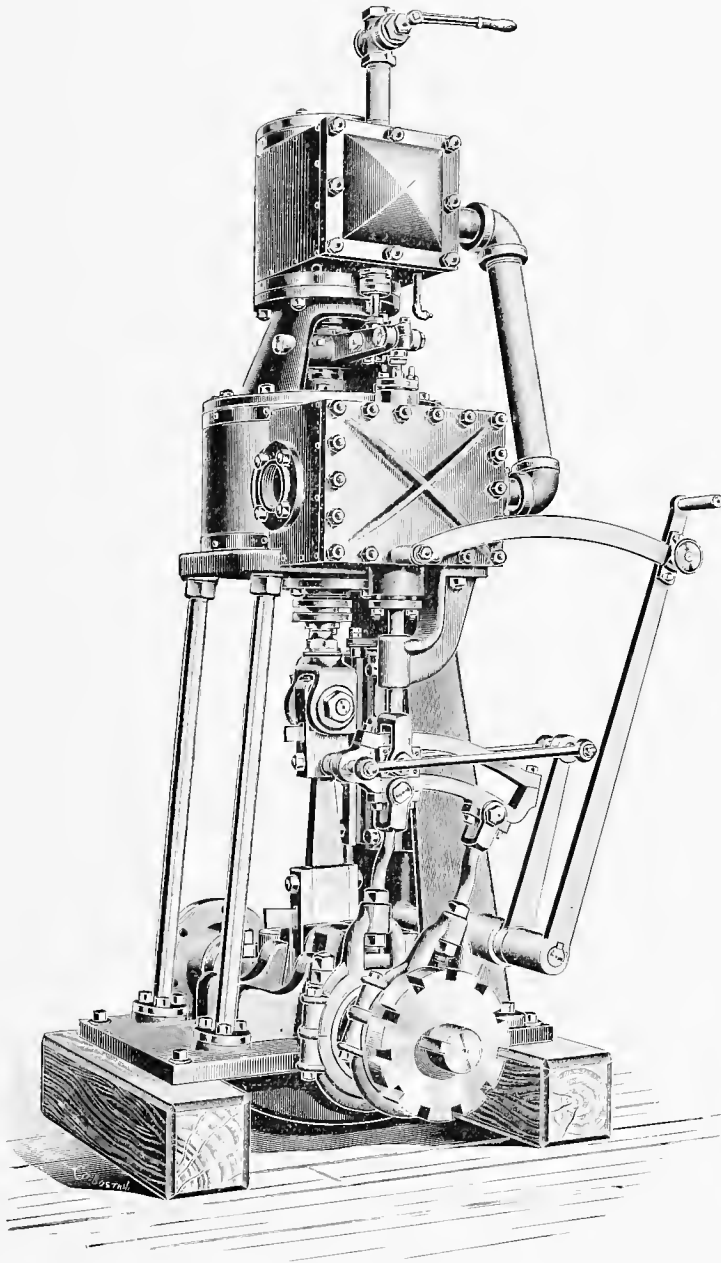

THE MORRIS STEEPLE COMPOUND ENGINE, 8 and 16 by 8.

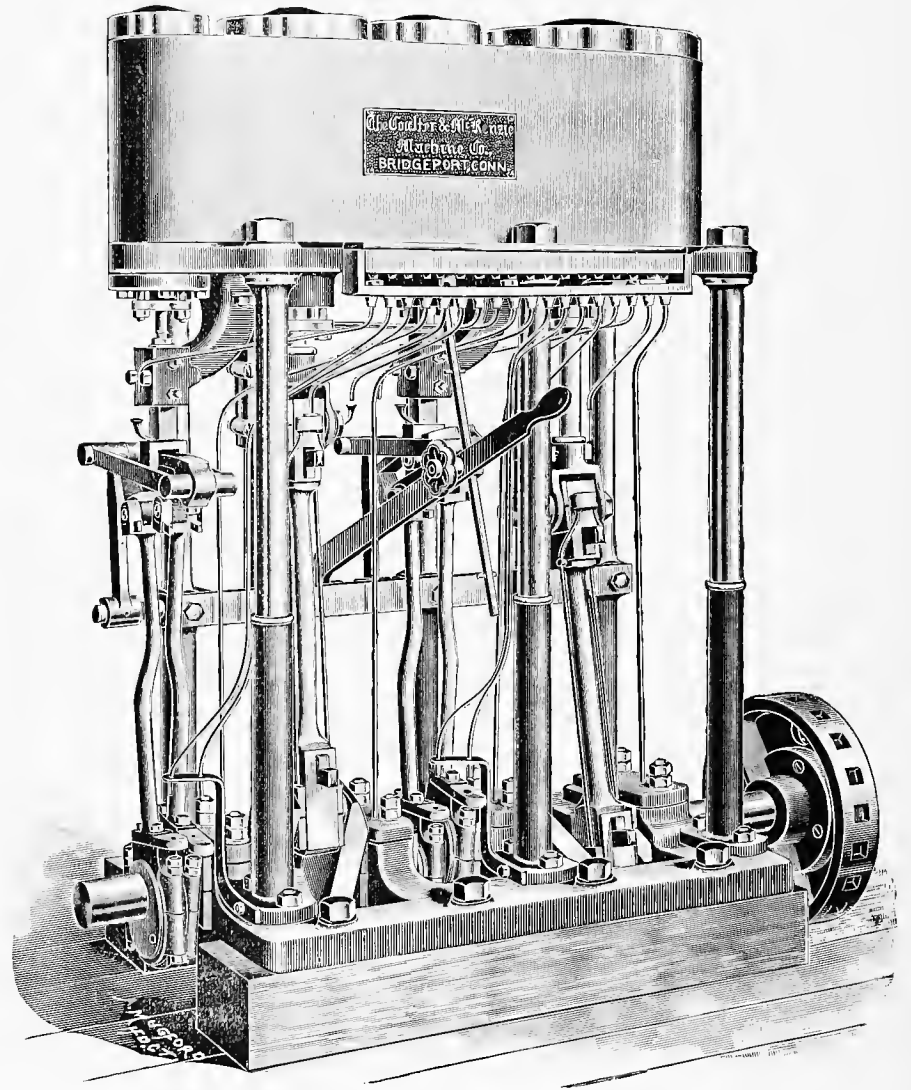

THE COULTER & MCKENZIE COMPOUND ENGINE IN YACHT DREAM.

it can be moved, hook on the eccentric-rod, and turn the eccentric in the direction to raise the required valve until it has the proper lead; then (if the engine is of the style that has two eccentrics and two rock shafts) proceed in the same manner with the exhaust valve gear, and the valves are set.

To prove the accuracy of adjustment, turn the main crank to its opposite center, and if there is a difference in the lead,

either lengthen or shorten the eccentric-rod to make up half the difference, and turn the eccentric to make the other half, fasten the eccentric on the shaft, and the valves will be right. There can be no general rule given as to how the eccentrics should be placed in relation to the crank, as that depends on the relative arrangement of the lifters, valves, wipers, and rock-shaft arms.—*The Engineer*, New York.

The Morris Compound Marine Engine.

This engine is built by the Morris Machine Works, Baldwinsville, N. Y. The engraving is of a 5 by 10 by 6-inch engine. The cylinders are cast separately and bolted together with a receiver between them. The high-pressure cylinder has a balanced valve of the same type as that used in the Straight Line engine. The valve on the low-pressure cylinder is a common D-valve. The cranks are arranged at an angle of 90 degrees to each other. All working parts, such as piston-rod, crosshead, connecting-rod, crank shaft and link motion, are made of steel. The cylinders are supported by cast-iron columns behind and polished steel rods in front, giving full view of all the working parts. Oil reservoirs are fitted on the back side of the engine, and by pipes leading from these reservoirs the crosshead guide, crank pin, and crosshead pin are automatically oiled. One of these engines, during a recent trial, ran continuously at 450 revolutions per minute, showing no tendency to heat.

The steeple and the fore-and-aft compound engines are both built with a view to having a strong and substantial engine, at the same time having a fairly light design and an engine in which every part can be easily seen in operation and readily got at. All the bearings are made to take up, except some of the smaller sizes in the link motion, where small bronze bushings are forced in, which can, when the bearings are worn, be driven out and replaced by new ones.

The small vertical engine shown in the cut is built by the Morris Machine Works, Baldwinsville, N. Y. The engine is made in eight sizes, the smallest being 5 by 5. It will be noticed that the engine contains several features not found in any other, the principal one being the frame, which should at once commend itself to users of small vertical engines. Free accessibility to all parts of the engine can be had at all times. These engines were designed for hard and continuous service, and are fitted in the best possible manner. The reciprocative parts are nicely counterbalanced, which will permit of high speed without vibration.

Compound Engine of Steam Yacht Dream.

The machinery that drives the fastest steam vessel ever built in Bridgeport, Conn., is the subject of this sketch. This boat is the steam yacht *Dream*, designed for H. M. Hills, co-proprietor of the *Evening Post* of that city. The vessel is 60 feet long over all, 12 feet beam, 5 feet deep, and draws 20 inches forward and 3 feet 4 inches aft. The power required is supplied by a Herreshoff water-tube boiler. A Worthington double-acting vacuum pump controls a keel condenser consisting of 48 feet of 3-inch pipe. The engine, as shown in the prospective view, is a fore-and-aft compound, designed and built by the Coulter & McKenzie Machine Co., of Bridgeport, Conn. It is capable of furnishing 75 horse-power, and turns a 3-foot screw of 4 feet 7 inches pitch 250 turns per minute with 100 pounds of steam. The high-pressure cylinder is 6 inches in diameter, the low-pressure 12 inches and the stroke 9 inches. Both cylinders are cast in one piece. The exhaust from the high-pressure cylinder passes around that cylinder and into the low-pressure valve, thus making a receiver and jacket in one and permitting the passage of steam to the low-pressure cylinder

without piping. The pistons are fitted with a sectional Dunbar packing, consisting of a solid center, or "bull" ring, on each side of which is fitted an L-shaped ring and a square ring, with good results. These rings are cut in three or four segments, as may be desired, and are adjusted so as to break joints. The rings are pressed against the walls of the cylinder by means of round wire springs of a diameter equal to the inside width of the rings. This construction insures even and sufficient pressure of the rings against the cylinder. The valves are of the balanced piston type, made up of a center and two end pieces held together by the valve stem and fitted with a steam-tight ring on each end. The live steam enters on the top of the valve, passes through the center and enters the cylinder from each end, the exhaust steam passing around the center, as will be understood. The valves are operated by Stephenson link motion, the connections of which have every adjustment. The link blocks are bronze bushed, with a hardened and ground steel bush working on a hardened steel pin. The links are made in halves and bolted together. The cylinders are supported upon six steel columns, which are securely fastened to a substantial cast-iron bed piece, making a frame which permits ready access to every part of the engine for repairs or adjustment.

The *Dream* is a wooden vessel, built by Geo. W. Masters, Bridgeport, Conn., in 1893. Referring to the illustration of sectional plan of cylinders: The exhaust from the high-pressure cylinder passes around that cylinder and into the low-pressure valve, thus making a receiver and jacket in one, and permitting the passage of steam to the low-pressure cylinder without piping.

Quadruple-Expansion Engines of the Steamship Kensington.

The International Navigation Company, of Philadelphia, Pa., had two large steel twin-screw steamers built in 1894 on the other side of the Atlantic—the *Kensington*, by James & George Thompson, of Clydebank, Glasgow, and the *Southwark*, by Wm. Denny & Bros., of Dumbarton, Scotland. The vessels are sister ships. The engines are of the quadruple-expansion type, direct acting and surface condensing. The four cylinders each work a separate crank, and they are so arranged as to produce the minimum of vibration, the parts being so disposed as to be practically balanced without the use of counterweights. The order of the cylinders from the forward end is high-pressure, second intermediate, first intermediate, low-pressure. The sequence of turning is high-pressure, low-pressure, second intermediate, first intermediate. Cranks are at right angles to each other. Diameters of cylinders are as follows: High-pressure, 25½ inches; first intermediate, 37½ inches; second intermediate, 52½ inches; low-pressure, 74 inches, with a common stroke of 4 feet 6 inches. The high-pressure and two intermediate-pressure cylinders are each fitted with piston valves, and the low-pressure has a double-ported flat valve. All valves are worked by a single eccentric radial valve gear. It is operated by a single eccentric through a quadrant rocking on trunnions. The reversing is obtained by moving the sliding block attached to the valve spindle from one end of the quadrant to the other. The lap and lead is secured by a separate lever worked from the crosshead of the

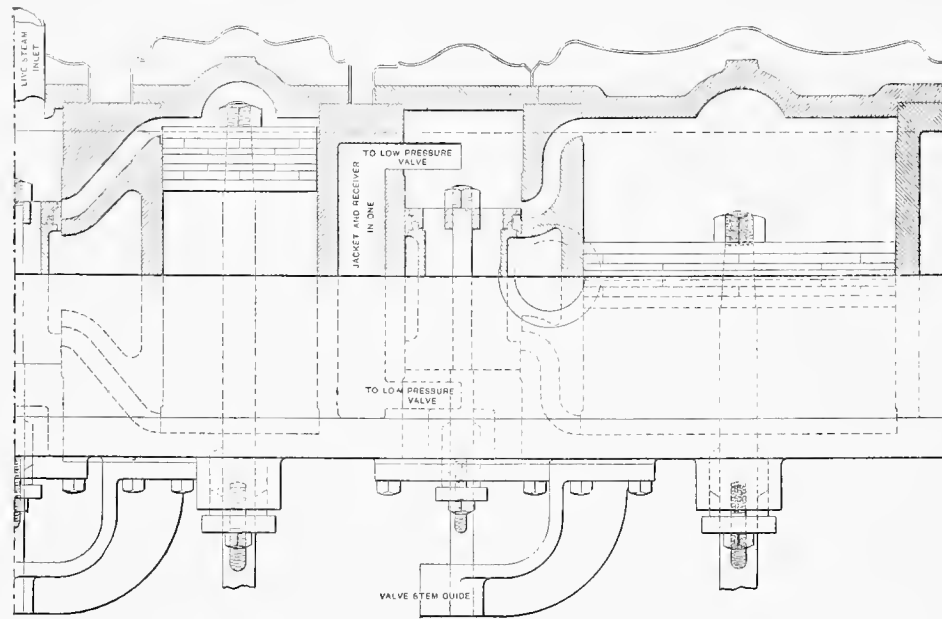

VERTICAL SECTION THROUGH CYLINDERS OF COULTER & MCKENSIE YACHT ENGINE.

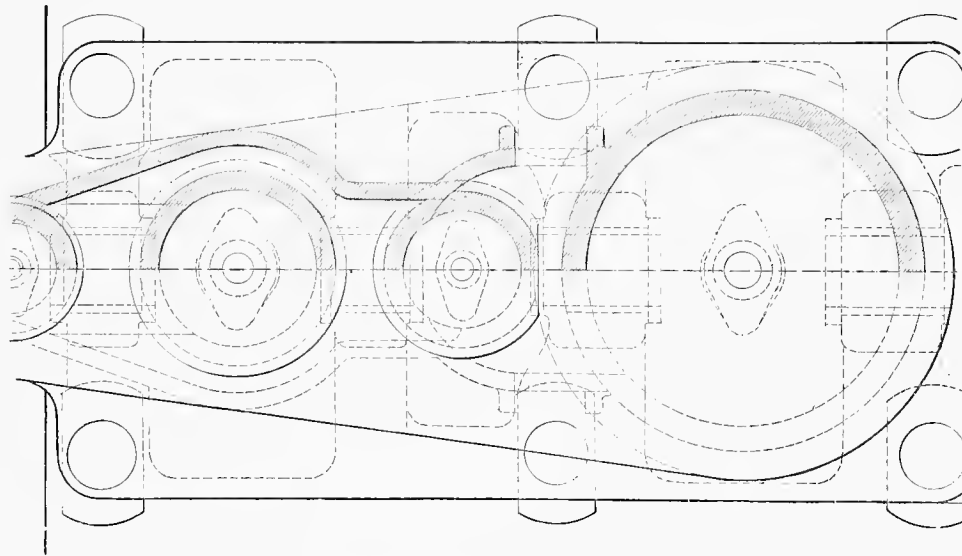

SECTION PLAN OF CYLINDERS.

main engine. This arrangement of valve motion allows of the valves of the engine being placed at the back, thereby bringing the centers of the cylinders much closer together and economizing space in the engine compartment; and, of course, adding to the cargo capacity of the ship. The total length of the engines is about 25 feet, which is much less than could be attained if the ordinary link gear had been used. The reversing gear is controlled by a Brown steam and hydraulic direct-acting engine.

In the construction of the engines, cast steel was largely

used. The shafting is of Siemens-Martin steel. The four cranks are each built up separately, and are interchangeable. The crank shaft is $14\frac{3}{4}$ inches in diameter, the thrust shaft 14 inches, and the tunnel shaft 14 inches. The thrust blocks are of the ordinary horseshoe type, of white metal, and there are seven rings. The blades of the propeller are of manganese bronze, while the boss is of cast steel. There are three blades to each propeller, the diameter being 17 feet, and the pitch 20 feet. The condenser is oblong, and supports the back of the cylinders. It is 19 feet long, of cast-iron, and is fitted with

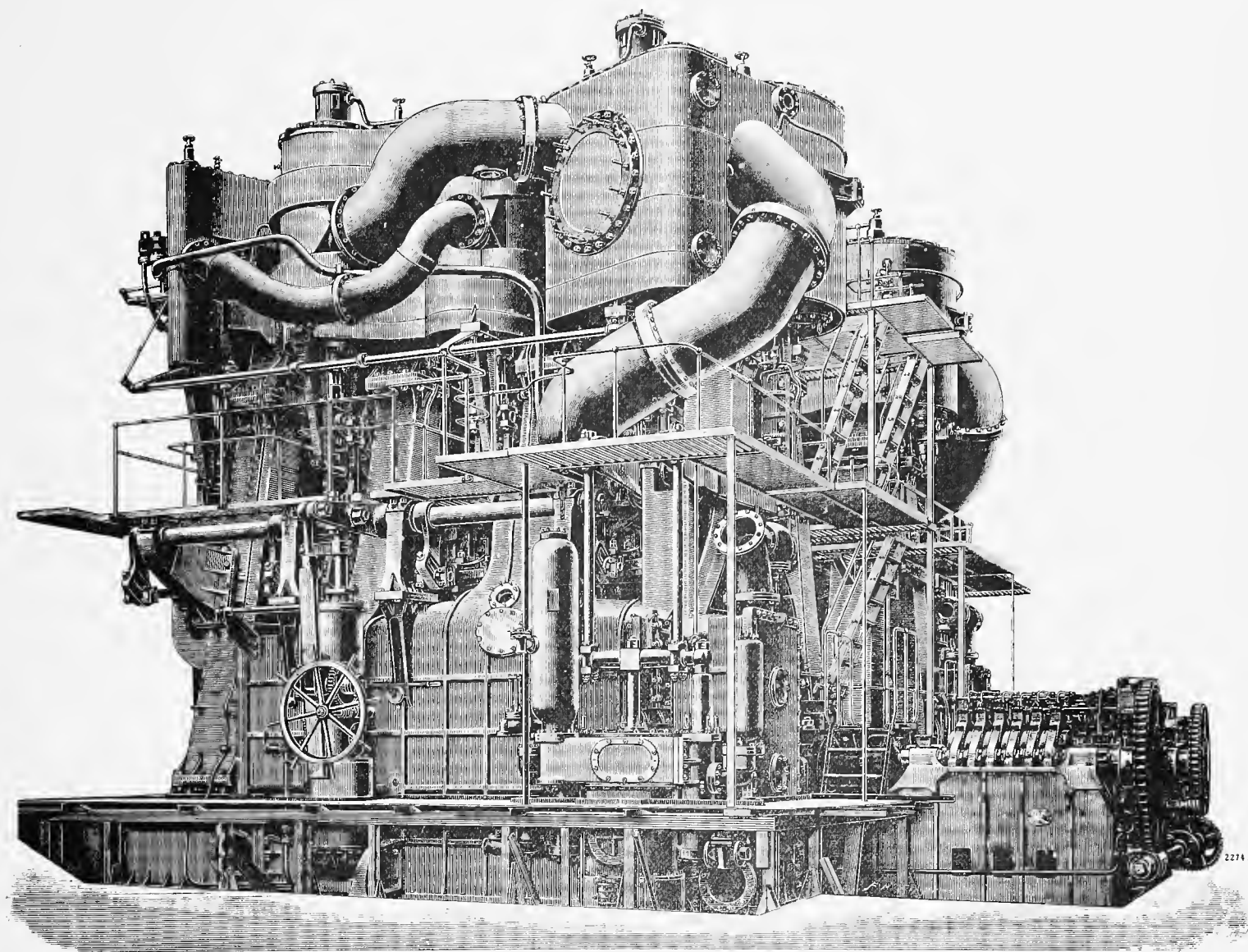

GENERAL VIEW OF THE QUADRUPLE-EXPANSION ENGINES OF THE INTERNATIONAL NAVIGATION CO.'S TWIN-SCREW STEAMSHIP KENSINGTON.

brass tubes, the cooling surface being about 10,000 square feet. The condensing water to each condenser is circulated by a large centrifugal pump driven by an independent engine. The air-pumps are driven by a lever working from the cross-head of a low-pressure engine in the usual way. There is also fitted a large evaporator to produce the necessary fresh water from sea water to make up the feed, and to avoid the use of salt water in the boilers. A large feed heater and filtering arrangements are provided. An auxiliary condenser has, in addition, been fitted on board, with a separate circulating-pump, so that all of the auxiliary machinery in the ship is worked separately from the propelling engines. An installation of Worthington pumps has been fitted on board.

There are three boilers in the ship, constructed of steel, and adapted for a working pressure of 200 pounds to the square inch. Two of the boilers are double-ended, and are 15 feet 9 inches in diameter by 21 feet 5 inches long, while the single-ended boiler is of the same diameter, but 11 feet 3 inches long. There are four furnaces at each end, making twenty in all, each with a Purves flue. These are 3 feet 4 inches mean diameter, the length of fire bar being 5 feet 9 inches. The total heating surface is 12,176 square feet, and the grate area is 383 square feet. The boilers are fitted with Serve tubes $3\frac{1}{4}$ inches in diameter, with $1\frac{3}{8}$ inches spaces between. There is fitted also a system of induced draught, patented by Ellis & Eaves. The boilers are in one compartment and

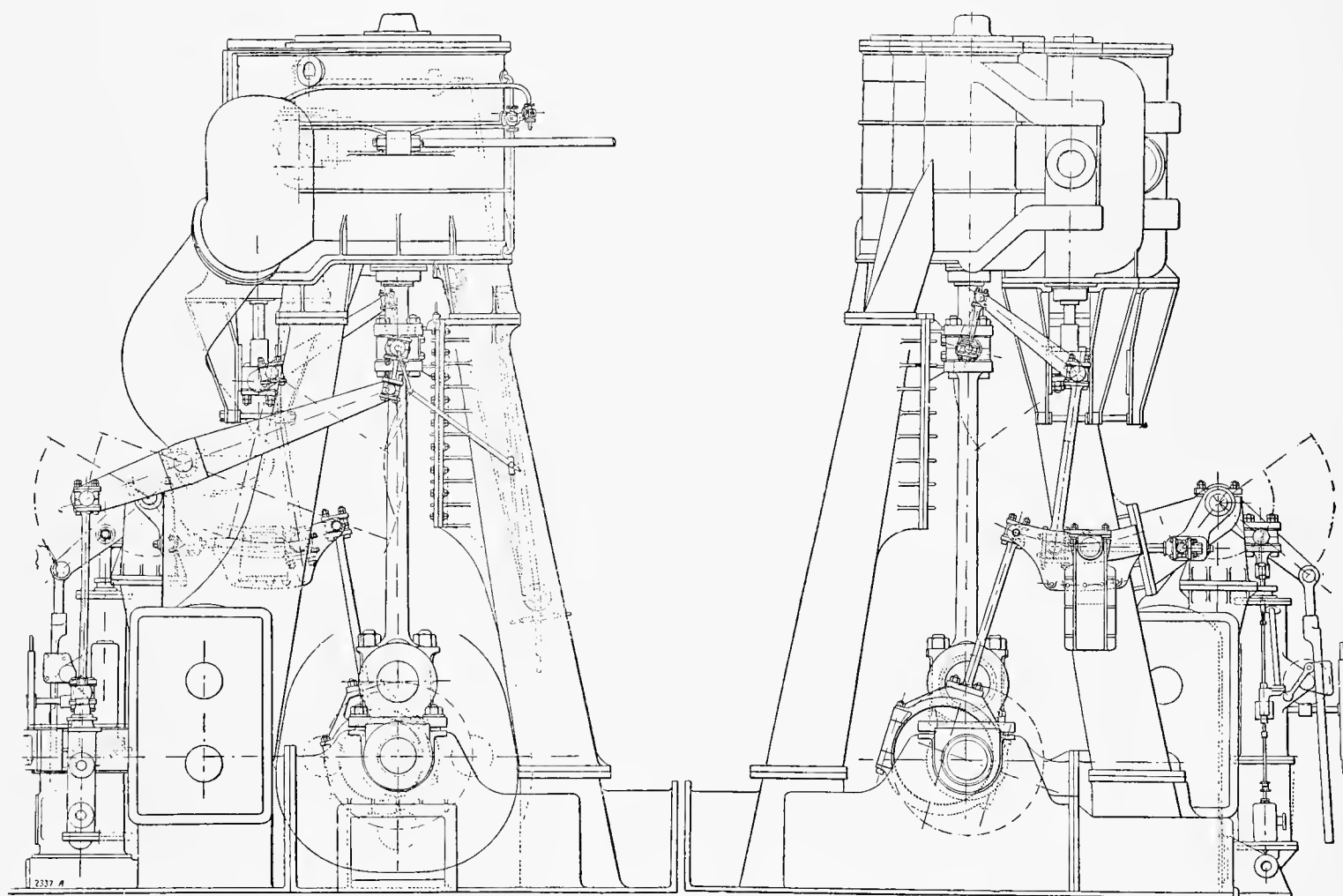

DRAWINGS OF END VIEWS OF ENGINES OF THE KENSINGTON.

exhaust into one chimney stack, which is 84 feet high from the grate level, and elliptical plan, 14 feet by 9 feet. The fans are 7 feet 6 inches in diameter, and are driven direct by Sturtevant engines running under ordinary conditions at a speed of 370 revolutions. The fans induce a draught through the furnaces, the air having previously been heated by passing through tubes placed in the way of the waste gases from the furnaces. The inlet of air to the furnaces is through tubes placed in a casing over the boiler, thence down a passage in front of the smoke box at the end of the boilers, and into the furnaces. The gases from the furnace, after passing through the boiler, pass around the tubes forming the air inlet, and subsequently pass into the funnel at the base of which are the five fans inducing draught through the passages thus briefly indicated.

At the trials on the measured mile at Skelmorlie, the dis-

placement of the vessel was 12,400 tons, the draught being, forward, 21 feet 9 inches; aft, 21 feet 7 inches; and mean, 21 feet 8 inches. Six runs were made, the mean results being as follows: Steam pressure, 199.5 pounds per square inch; air pressure in stokehold, 3.16 inches; revolutions, port engine, 86.4; revolutions, starboard engine, 86.9; indicated horse-power, both engines, 8,313; vacuum, 27 inches; speed, 15.8 knots. The temperature at the base of the funnel was about 550 degrees Fahrenheit. On her first trip to Philadelphia the speed averaged 14.1 knots, and on the homeward run 13.7 knots, the indicated horse-power being about 7,000.

The dimensions of the hull are: Length between perpendiculars, 480 feet; breadth, moulded, 57 feet; and depth, moulded, 40 feet. She is built throughout of Siemens-Martin steel, and is subdivided by nine water-tight bulkheads.

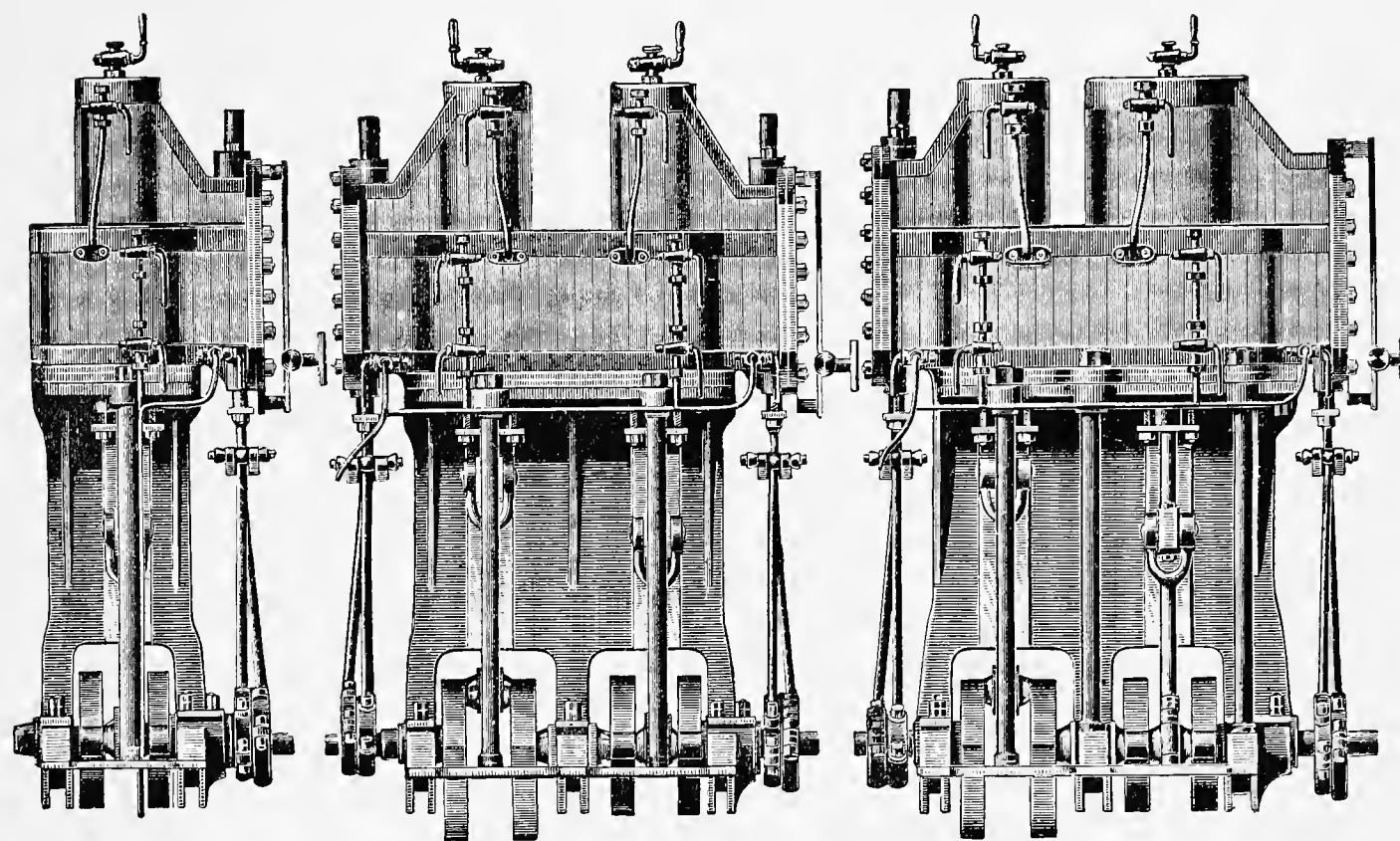

SINGLE COMPOUND.

DOUBLE COMPOUND.

QUADRUPLE EXPANSION.

THE "KINGDON" PATENT ENGINE, FOR STEAM LAUNCHES.

Constructed by Simpson, Strickland & Co., Dartmouth, South Devon, England.

The Kingdon Patent Engine for Steam Launches.

In these engines only one valve is needed to regulate the admission and emission of steam in the cylinders, which are both double acting, consequently there are no more moving parts than in a single cylinder engine. The grade of expansion is directly proportioned to the area of the cylinders, and there is far less loss of pressure between them than is the case in most compound engines, owing to the shortness of the passages, and owing also to the fact that the temperature of the steam is maintained during its passage through the valve by the live steam with which it is surrounded. The steam is carried throughout about nine-tenths of the stroke in all cylinders, and consequently the effort on the crank shaft is very uniform. Both pistons being on the same piston rod, the strains on the crank shaft, due to an unequal amount of work being done in the two cylinders at different portions of the stroke, are entirely done away with. These engines are constructed by Simpson, Strickland & Co., Dartmouth, South Devon, England.

Haug's Compound Marine Engine.

In the accompanying cut, Fig. 1 shows a compound marine

engine in which the pistons travel in opposite directions, the cranks being set at 180 degrees. The principal novelty in the design is the piston valve, which admits steam to the high-pressure cylinder, then exhausts it into the low-pressure cylinder, and finally into the atmosphere or condenser. The distribution of the steam by means of this valve is clearly indicated in Fig. 2, which shows a sectional elevation, a sectional plan, and a plan of the cylinders and valve. This figure also serves to show the compactness with which the cylinders and valve may be arranged, the valve being operated by a radial valve gear. A quadruple-expansion engine can be arranged on this principle, one set of cranks being placed at 90 degrees with the other set, as shown in Fig. 3, thereby securing a nearly perfect balance of working parts with great uniformity of motion, and comparative simplicity.

Charles Ward, of Charleston, W. Va., put a small engine of the type shown in Fig. 1 into the steam launch Mascot, built by him for the War Department, Engineer Corps. The hull, which is constructed of steel, is 61 feet long, 8 feet 1 inch beam, 3 feet 4 inches deep, drawing 7 inches forward and 14 inches aft. The engine has cylinders 6½ and 13 inches in diameter, 8 inches stroke. During the trial the engine ran at the rate of 540 revolutions per minute, driving the boat 13¼ miles per hour.

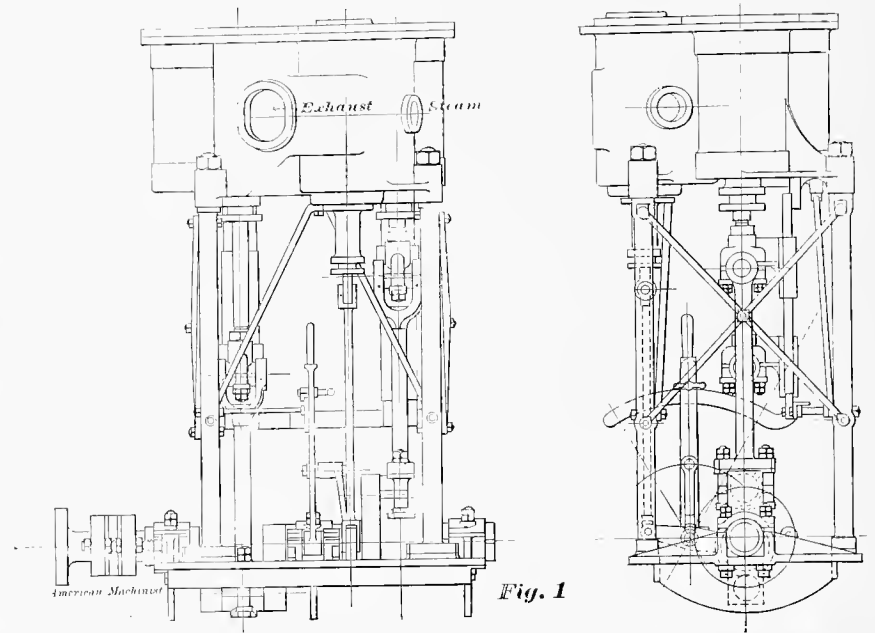
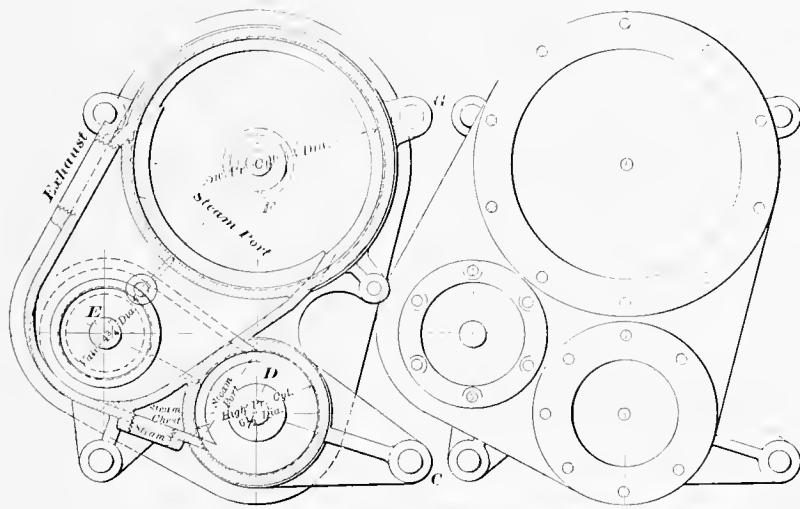

Fig. 1

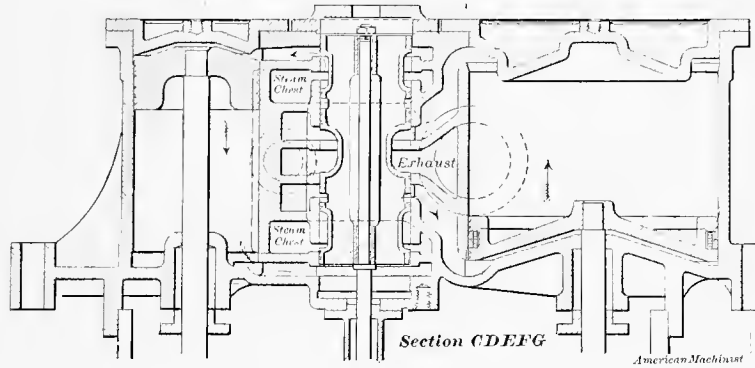

Fig. 2

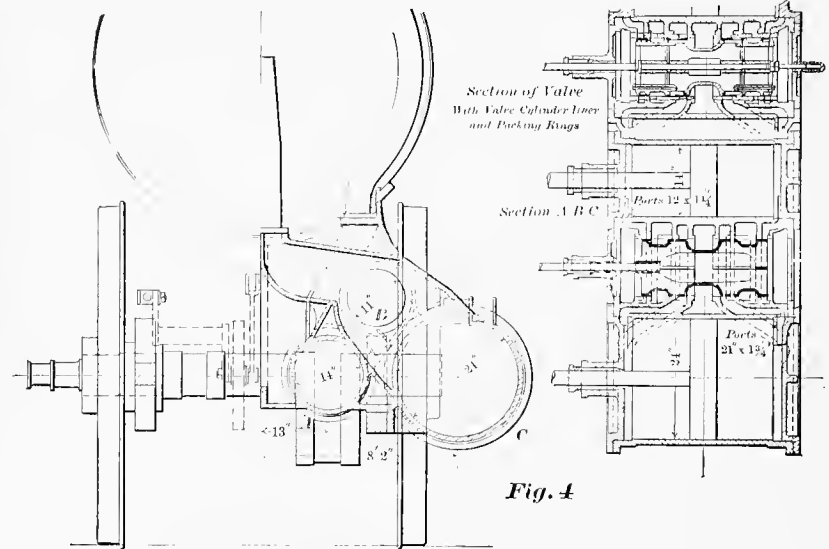

Fig. 4

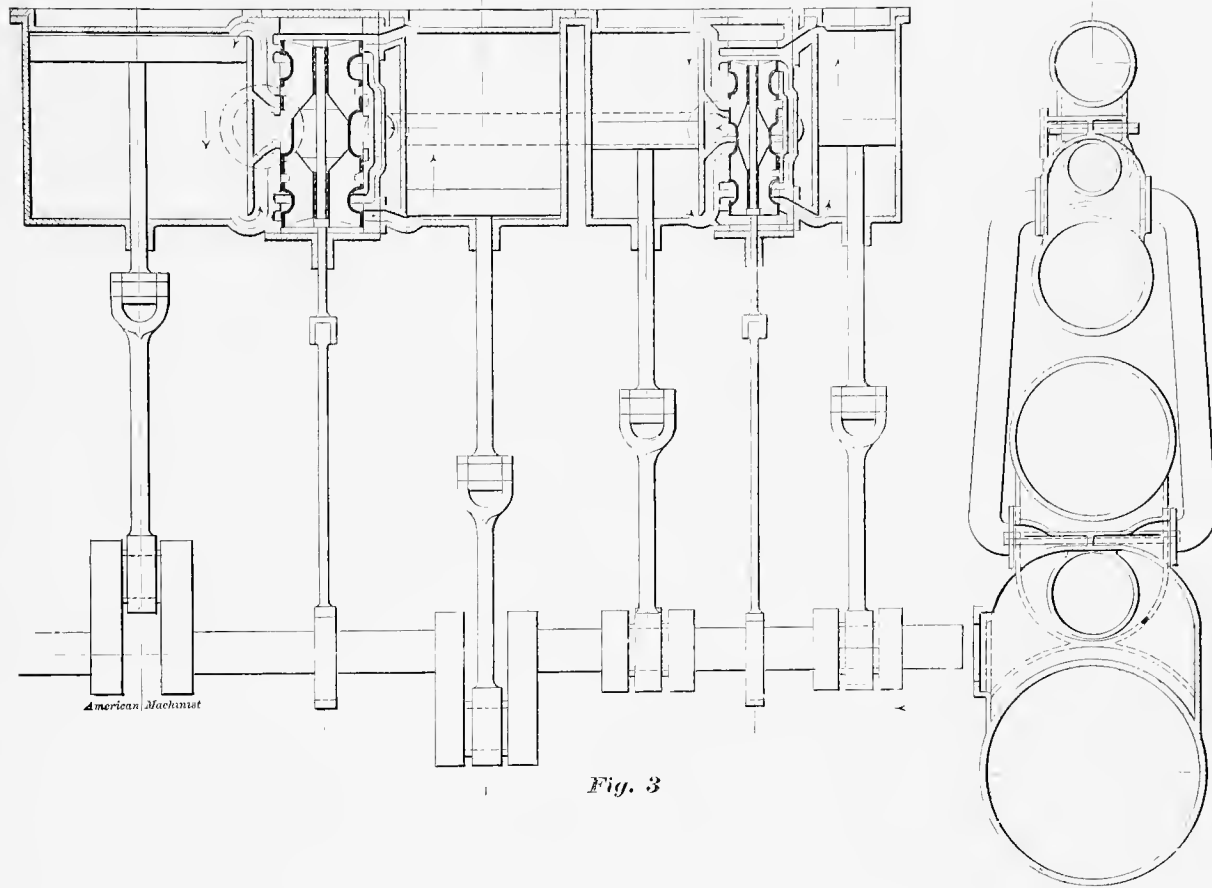

Fig. 3

HAUG'S COMPOUND MARINE ENGINE.—Designed by John Haug, Philadelphia, Pa

The engine worked non-condensing ; steam was supplied by a Ward boiler of the launch type, having a grate surface of 4 square feet, and 80 square feet of heating surface. The weight of boiler is 965 pounds ; water in the boiler, 110 pounds ; engine complete, 1,000 pounds. There was no opportunity to take indicator diagrams from the engine, but the horse-power was judged to be from 70 to 75, or one horse-power for every 27 to 30 pounds weight of machinery. The accompanying designs were made by the inventor of the valve, John Haug, Mechanical Engineer and Naval Architect, Philadelphia, Pa.

Composite Steam Light-Vessel.

On April 11, 1895, the Lighthouse Board, Washington, D. C., opened bids for another of the high-class, electrically-lighted light-ships that have of late been introduced into the service. The illustration gives an idea of what the boat is like. This vessel is of composite construction, 112 feet on the water line, 28 feet 6 inches moulded breadth, and 13 feet depth of hold. The frame is of steel with steel-plate keel, steel bilge strake and steel sheer strake. Wood planking is

used from the keel up to the sheer line at the main deck, and from that point up to the spar deck steel plate is used. The frames, floors, keelsons, stringers, beams, shear strake, bilge strake, strapping, keel plate, etc., are of steel ; stem, stern-post, rudderpost, rudder, false keel, shoe, sheathing and grip on stern, bilge keels are of white oak ; keel, planking and deadwood of long-leaf Georgia or Florida pine. Fastenings in plank, keel and deadwood are of galvanized iron ; in the wood sheathing, composition spikes. The metal sheathing is 26, 28 and 30-ounce metal, double punched. The propelling engine, which will, of course, be of use only in moving the vessel to and from her station or for handling her in case of accident that might remove her from her moorings, is about 350 horse-power, and of the vertical inverted surface condensing type, with a single cylinder 20 inches diameter and 22 inches stroke of piston. There are two main boilers of 300 horse-power each and two auxiliary of about 40 horse-power each. The main boilers, of the Watkin & Dixon type, the same as those built by Heipershausen Bros., New York, for several harbor tugs, are not more than 14 feet long, 8 feet wide and 8 feet 6 inches high from under side of furnace leg to top of shell, the shell 8 feet diameter. The electric light plant consists of two

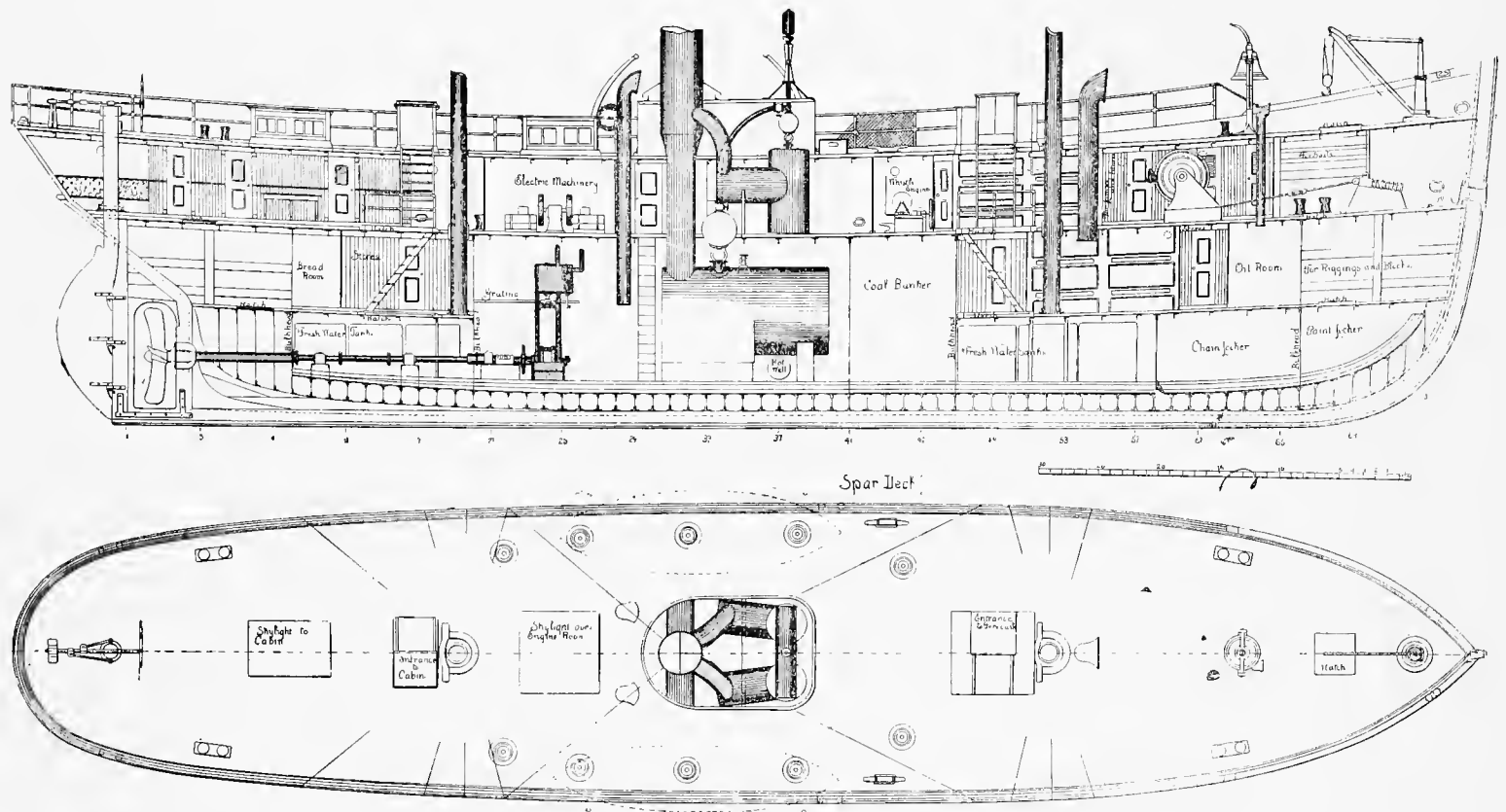

PLANS FOR A COMPOSITE STEAM LIGHT VESSEL FOR THE WOODS HOLE, (MASS.) STATION.

of the General Electric Company's marine sets known as m. p. 4-8.550, with 5 by 4-inch double-cylinder Sturtevant engines. The cost of this vessel was about \$70,000. The contractors for the construction of the ship were the Bath (Maine) Iron Works.

The Composite Auxiliary Steam Yacht *Satanella*.

This beautiful craft was designed by I. S. White, and built by White Bros., Cowes, Isle of Wight, England, in 1881. She is a composite vessel, having an iron frame planked with wood, and was christened *Golden Fleece* by her owner, W. H. Roberts. In 1891 she was brought to America by the late Francis T. Osborne, and afterward became the property of Perry Belmont, of New York, who changed her name as above. Dimensions: Length over all, 136 feet; load water line, 113½ feet; beam, 22½ feet; draught, 13½ feet; net register, 114.97 tons; C. H. M., 169.8 tons; has compound engines 13½ and 22 by 13 inches, built by G. E. Belliss, Birmingham, England.

The Steam Yacht *Free Lance*.

The dimensions of this vessel are: Length over all, 137 feet; load water line, 108 feet; beam, 20 feet; draught, 6 feet 9

inches. Engines, triple-expansion, 11, 17 and 29 by 20 inches, which develop over 500 indicated horse-power.

Steam is furnished by two Army water-tube boilers. These steam generators are each 8 feet 4 inches high, 6 feet 4 inches long, 4 feet 6 inches wide, giving 1600 square feet of heating surface and 52 square feet of grate. The owner of the *Free Lance* is F. Augustus Schermerhorn, New York.

The frames are of steel angles 2½ by 2½ by ¼ inches, spaced 24 inches apart from centers in one piece from keel to main deck lodger plate. Floors are of plate steel 3-16 inch deep and are gradually deepened aft on a fair line to stern post. Overhang aft is braced with a plate keelson of 8.12 pounds steel cut down on frames and clipped to skin, and also one under the deck. There is one center line continuous keelson running from bow to stern, extending above the floor two inches and secured with a double angle back to back. Sister keelson, between the center keelson and bilge, is continuous on each side of plates. Under the engine and boiler space proper, steel keelsons are placed as required for machinery, and they are gradually tapered forward and aft to strengthen the boat just forward and aft of engine space. Bulkheads are as follows: Collision bulkhead at bow, of 7.35 pounds steel stiffened with 1¾ by 1¾-inch angles; one at fore end of boiler space of same weight; a light one between boiler space and engine-room, merely to keep dust out; one aft of engine space, same as bow, and one at stern tube;



COMPOSITE AUXILIARY STEAM YACHT SATANELLA.

also two light ones between the engine and boiler-room, to be utilized as a coal bunker. The main deck beams are of steel angles $2\frac{1}{2}$ by $2\frac{1}{2}$ by $\frac{1}{4}$ inch, one on each frame in one piece and well secured to side by gusset plates curved on inner edge. All plating is of steel. The main deck is of selected white pine $2\frac{1}{2}$ by $2\frac{1}{2}$ inches, bolted with special bronze screw bolts, put in from the bottom, U. S. Navy style. House deck is of well-seasoned mahogany tongue and grooved $1\frac{1}{4}$ inches thick. Cabin deck is layed with well-seasoned white pine $1\frac{1}{4}$ inches thick. A. Cary Smith was the designer of the yacht.

ENGINES OF THE STEAM YACHT FREE LANCE.

With this we give an illustration of the engine for the

steam yacht Free Lance, built for F. A. Schermerhorn, of New York, by Lewis Nixon, at the Crescent Shipyard, Elizabethport, N. J., from the designs of A. Cary Smith, of New York, the engines being designed by Charles C. Bowers, superintending engineer of the shipyard.

The engine is of the inverted direct acting triple-expansion type, with cylinders 11, 17 and 29 inches diameter and a stroke of 20 inches. The cylinders are mounted in the order of high, intermediate and low-pressure, with the high-pressure valve on the forward end of the engine, the intermediate pressure valve between the high-pressure and intermediate pressure cylinders, and the low-pressure valve on the after end of the engine. The steam ports in high-pressure cylinder are $1\frac{3}{4}$ by

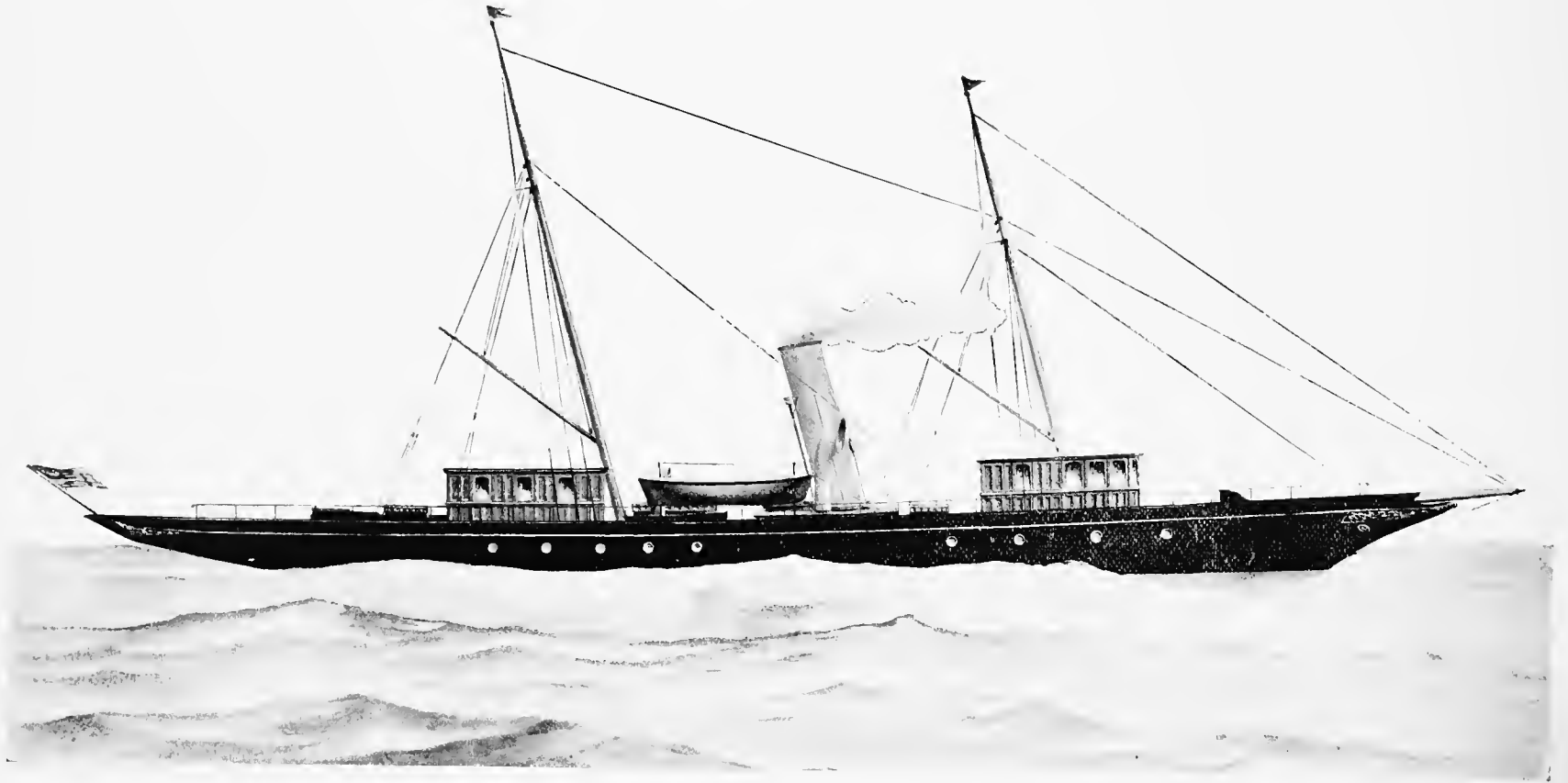

F. AUGUSTUS SCHERMERHORN'S STEAM YACHT FREE LANCE.—Built by Lewis Nixon, Elizabethport, N. J., from Designs of A. Cary Smith.

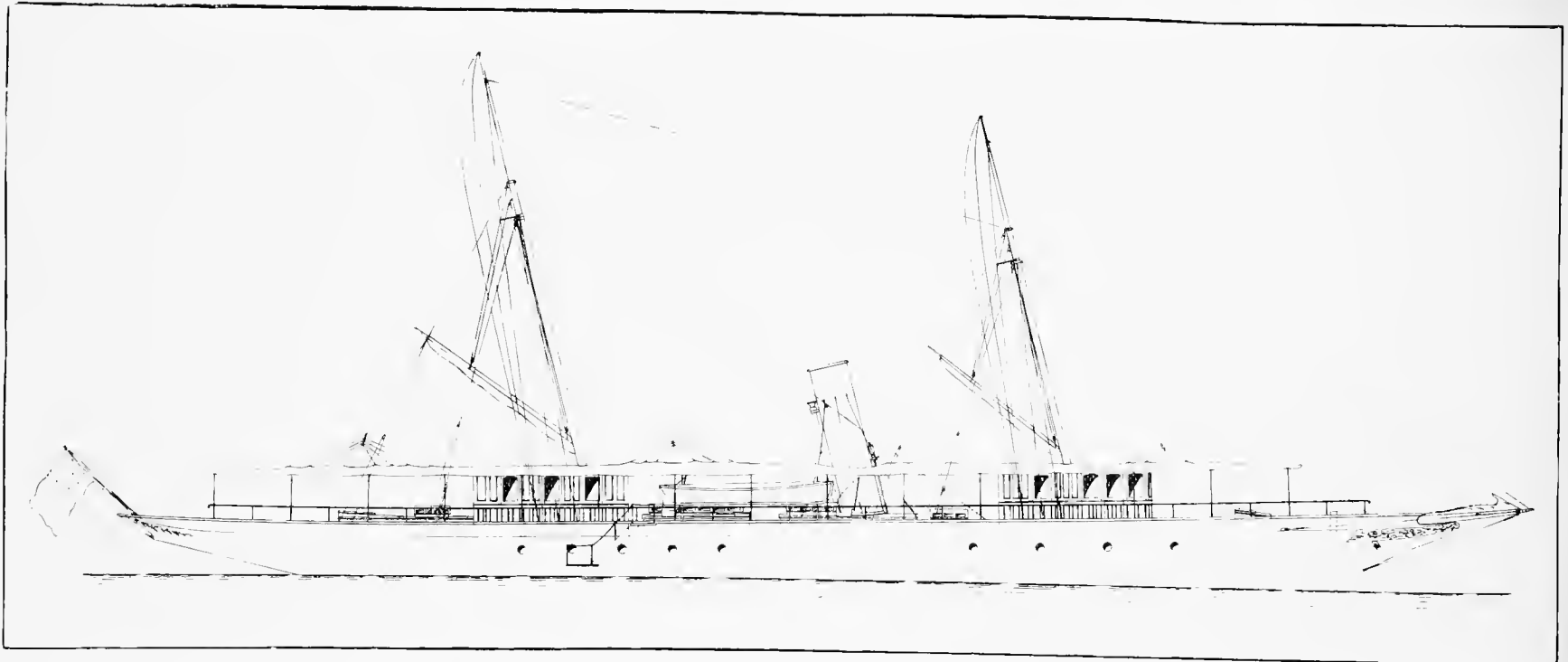

SHEAR PLAN OF THE STEAM YACHT FREE LANCE.—Built by Lewis Nixon, Elizabethport, N. J., from Designs of A. Cary Smith.

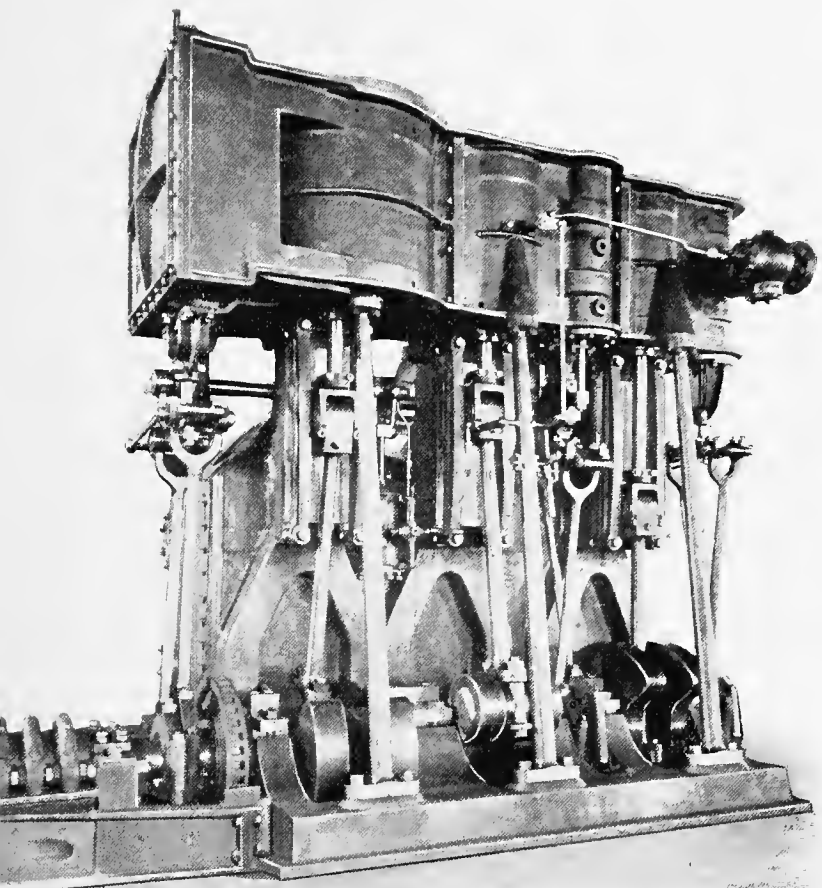

ENGINE OF THE STEAM YACHT FREE LANCE.

9 inches; intermediate pressure cylinder, $2\frac{1}{4}$ by 17 inches. There are double ports in the low-pressure cylinder, each $1\frac{3}{4}$ by 30 inches. The throttle valve is balanced and fitted with a relief valve. The high-pressure cylinder is fitted with a piston valve 6 inches diameter; the intermediate pressure cylinder with two piston valves each 6 inches diameter, and the low-pressure cylinder with a large double-ported D-slide valve. The piston valves have self-setting spring rings. Liners are fitted to the steam chests of the high-pressure and intermediate pressure cylinders, and the low-pressure steam chest has a false seat or liner for the slide valve to work on. All valves have $\frac{1}{4}$ -inch travel and are worked direct by the regular Stevenson double-bar link. The valve stems of the high-pressure and intermediate pressure valves are $1\frac{3}{8}$ inches diameter, and for the low-pressure $1\frac{3}{4}$ inches. They are made of steel and work in guides fitted with brass bushings. The eccentrics are of cast-iron 2 inches wide for the high-pressure, and $2\frac{1}{4}$ inches wide for the intermediate pressure and low-pressure cylinders, with cast-iron straps.

The high-pressure eccentrics are fitted to the end of the shaft, which is turned down to 2 inches diameter to receive them, thereby allowing the use of eccentrics of much smaller diameter than those of the other cylinders. The engine is supplied with steam reversing gear having a cylinder 5 inches diameter, 10

inches stroke, and fitted with gag for adjusting the cut-off; all are under easy control of the engineer. All pistons are cast-steel disks 3 inches deep at sides and attached to the rods by a quick taper and nut. All the pistons have two rings side by side, backed up by a third ring of the same width as the two outside ones, and in the low-pressure piston the three rings are reinforced by nine helical springs 1 inch outside diameter, and about $1\frac{1}{4}$ inches long, made of $\frac{1}{8}$ -inch brass wire. The cylinders are carried by the condenser at the back, and three wrought-iron columns in front, which form the frame of the engine. The bed plate is of the girder type 7 feet $8\frac{5}{8}$ inches long, conforming to the shape of the vessel, and has 5 main journal bearings. The crank shaft is of solid forged steel 6 inches diameter. The cranks are placed 120 degrees apart in order of high-pressure, intermediate pressure and low-pressure, and are counter-balanced. The thrust bearing has six collars forged on. All crank-pin brasses, main bearings and eccentric straps are lined with anti-friction metal. The condenser is of cast iron 6 feet $11\frac{1}{4}$ inches between the tube sheets, and has 602 brass tubes $\frac{5}{8}$ inch diameter; the tube sheets are $\frac{7}{8}$ inch thick. A rotary circulating-pump 18 inches diameter, with blades 3 inches wide at the root tapering to $1\frac{1}{2}$ inches at the outer end, is bolted onto the end of the condenser and run by an independent engine with a cylinder 5 inches diameter by 5 inches stroke; also bolted to the condenser and attached direct to the shaft of the circulating-pump. The air, feed and fire-pumps are all independent. The engine is finely and substantially built, and for the speed and power it developed takes up very little space, and all parts are within easy reach of the engineer. The engine was built by S. L. Moore & Sons, Elizabethport, N. J. The dimensions of hull are as follows: Length over all, 137 feet; on water line, 108 feet; beam, 20 feet; draught, 6 feet 9 inches.

The Steam Yacht Formosa.

The hull of this yacht is of mild steel throughout. Dimensions, length over all, 157 feet; beam, moulded, 22 feet; depth, 12 feet 5 inches; draught, with all stores on board, 9 feet 6 inches.

Her maximum speed under forced draught is about 17 miles; her continuous speed under natural draught 15 miles, and she is exceptionally free from vibration at all speeds. From her design upwards she is the product of the Atlantic Works, of East Boston, Mass. The specifications for hull and machinery were written by Wm. T. Keough, engineer of the company. The lines of the hull are by the well-known naval architect, Richard F. Keough, of East Boston, and she was rigged by A. B. Low & Co. She was built in 1894 for Geo. F. Fabyan, of Boston.

ENGINES OF THE STEAM YACHT FORMOSA.

The small half-tone cut represents the engines of steam yacht Formosa, built by the Atlantic Works, East Boston, for George F. Fabyan. This vessel is a sea-going yacht. Her propelling engines are of the vertical inverted triple-expansion type, $13\frac{1}{2}$, 21, 34 by 22 inches. The cylinders are all cast separately, bolted together and fitted with outside connecting passages consisting of copper pipes. The framing is of vertical steel columns stayed with diagonal rods. The condenser is cylindrical, of cast iron, and contains 1,200 square

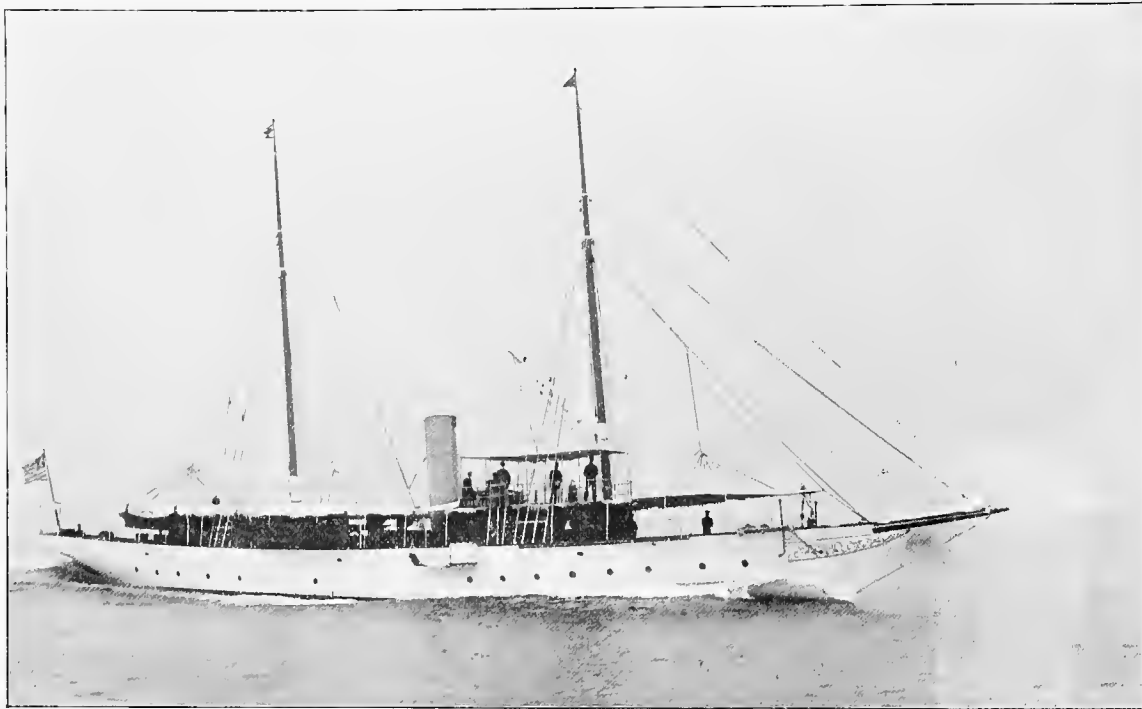

STEAM YACHT FORMOSA.—Built by the Atlantic Works, East Boston, Mass., for Geo. F. Fabyan.

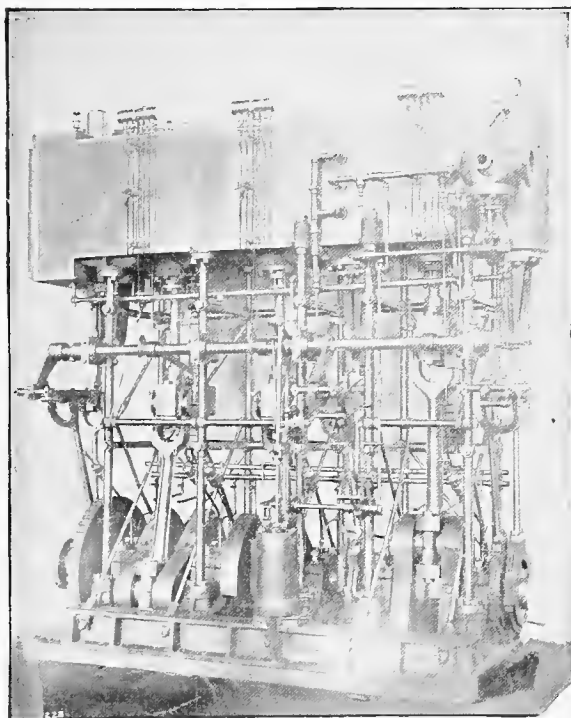

ENGINES OF STEAM YACHT FORMOSA.

feet of cooling surface. The combined air and circulating-pump is of the horizontal type. The feed-pump is of the vertical duplex type, controlled automatically. There are also two other pumps for general purposes. She is fitted with three inspirators of the Hancock locomotive type. The boilers are of the Almy water-tube type, three in number, two main boilers and one donkey boiler. They are designed and built for a working pressure of 225 pounds per square inch. She is fitted for forced draught on the closed stokehold system, the air being forced in by means of a Sturtevant fan driven by a pair of engines connected direct to the shaft of the fan. This arrangement has proved very satisfactory, as even at the highest speed the fire-room is unusually cool and comfortable.

The Steam Yacht Peregrine.

This craft was designed by C. R. Hanscom, Bath, Me., for R. H. White, of Boston, Mass. Dimensions: Length over all, 158 feet 3 inches; load water line, 131 feet; beam, extreme, 23 feet; depth of hold, 13 feet; mean draft, 10 feet; extreme draft, 10 feet 9 inches. In the forward hold is located the cold storage room and large compartments for stores, and in the after hold are the engineer's stores, wine-room and three fresh water tanks with a capacity of about 2,500 gallons of water. A large tank is also located amidships with a capacity of 3,500 gallons of water, and small tanks are fitted in the engine-room for hot and cold, salt and fresh water. The motive power consists of a vertical triple-expansion engine, 14, 21, 34½ by 22 inches. Piston valves are used throughout, and the high-pres-

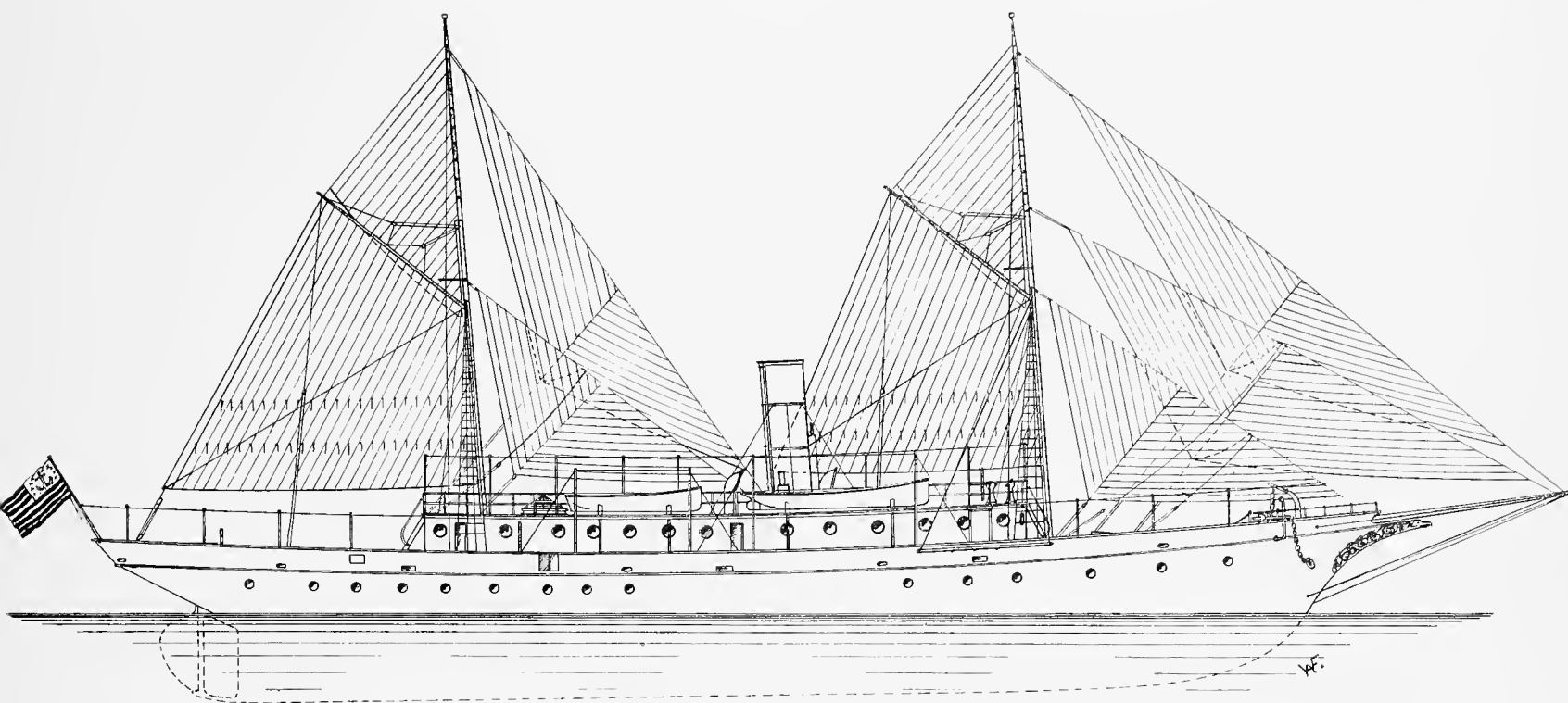

STEAM YACHT PEREGRINE.—By the Bath (Maine) Iron Works, for R. H. White, of Boston, Mass.

sure cylinder is placed in the center, the intermediate forward and the low aft. The condenser forms part of the framing at the back of the engine, and the cylinders are well supported and braced by steel columns. The propeller is of manganese bronze, four-bladed, with a diameter of 8 feet 3 inches and a pitch of about 10 feet. There are two Almy water-tube boilers, built for a working pressure of 185 pounds each, occupying a space 83 inches long, 83 inches wide and 104 inches high. The grate surface is 65 square feet, and the heating surface about 2,500 square feet. The designed indicated horse-power is 800, and this gives the vessel a speed of over 14 knots. The Bath Iron Works were the contractors for the hull (which is of steel) and machinery.

Twin-Screw Steam Yacht Hirondele.

This craft was designed and built by Chas. L. Seabury & Company, Nyack, N. Y. Her dimensions are as follows: Length over all, 85 feet; load water line, 74 feet 9 inches; beam, 13 feet 6 inches; draft, 4 feet 6 inches. The keel, stern and stem post are of white oak, the deadwoods are of oak and yellow pine, timbers of selected white oak, steam-bent; the floors or heel straps of best white oak, and planking of selected yellow pine. She is copper-fastened and riveted. The machinery consists of two triple-expansion engines, and a Seabury patent safety water-tube boiler. The galley is forward of the engine-room. The yacht was built in 1893 for Caleb G. Evans, New York.

The Steam Yacht Valiant.

After the iron steam yacht Alva (built by Harlan & Hollingsworth Company, of Wilmington, Del.) was sunk off the Massachusetts coast by the Metropolitan Line steamship H. F. Dimock, it was decided by her owner, W. K. Vanderbilt, of New York, to have a large twin-screw yacht built in England, from plans of St. Claire Byrne, of Liverpool, by Laird Bros., of Birkenhead, England. The Valiant is of the following principal dimensions: Length over all, 331 feet; on load line, 293 feet; beam, 39 feet; depth, 25 feet 3 inches; tonnage, 2,184; yacht measurement, 1,823 gross register; double bottom for water ballast purposes, 180 tons; for fresh water, 30 tons, and the fresh water tank capacity is 50 tons. The deck houses, about 175 feet in length, and the bulwarks are of steel, but the whole paneled in teak. The engines are twin-triple compound. The cylinders are 23, 36 and 55 inches by 3 feet stroke; boilers, two double end and a single end, fifteen furnaces in all; 160 pounds pressure. At a trial in Liverpool Bay under natural draught, a speed of upwards of $15\frac{1}{4}$ knots was established. This may be assumed to be the ordinary sea-going speed. Under forced draught and full power she ran for upwards of six hours, and the mean revolutions being 145 per minute; 170 knots was covered in 10 hours and 50 minutes, giving an average of 15.7 knots. On the measured mile, under forced draught, the mean two runs gave upwards of 17 knots, while the mean of the whole series was a fraction below. Weather squally and strong breeze, but the result very satisfactory, as she had 700 tons of coal and stores on board,

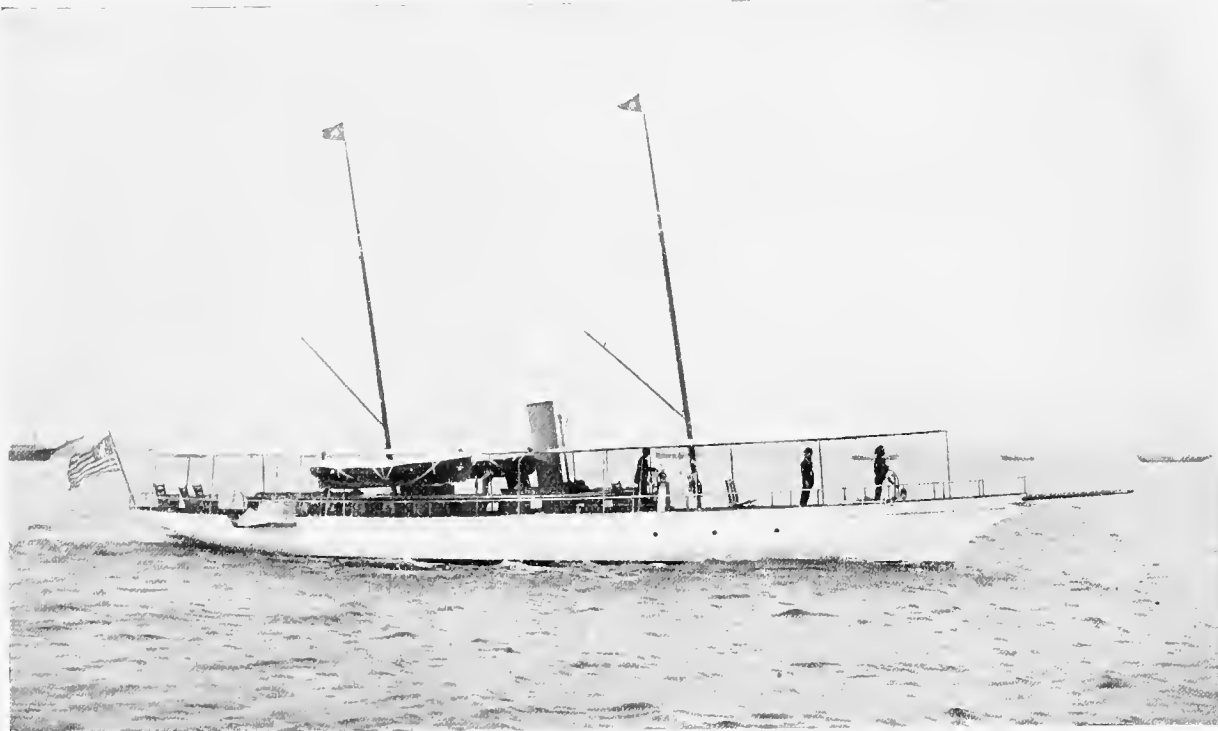

TWIN-SCREW STEAM YACHT HIRONDELLE.—Built by Chas. L. Seabury & Co., for Caleb G. Evans.

sufficient for a run across from New York to the Mediterranean ports at 15 knots speed without intermediate call. The Valiant is the only brig-rigged steam yacht afloat. She even carries a fore and main royal like a sailing vessel.

The Steam Yacht Marietta, No. 2.

This craft was built in 1895, and is the second yacht of her name built by the Pusey & Jones Company, Wilmington, Del., from plans of Henry J. Gielow, New York, for H. B. Moore, of this city. The designer says: "In preparing the plans of the Marietta, the principal ends in view were good accommodation and economical maintenance of a reasonable high speed for a cruising craft. The yacht is 142 feet 6 inches over all, 118 feet load water line, 16 feet beam, 8 feet 11 inches depth of hold, and 6 feet and 6 inches draught. The hull is of mild steel, the keel being 5 $\frac{1}{2}$ inches by 1 $\frac{1}{8}$ inches; frames 2 inches by 2 inches, 3 pounds per foot; floors 10 inches deep and from 3-16 to $\frac{1}{4}$ inch in thickness; plating from 3-16 inch to 5-16 inch thick. The bulkheads are three in number, a collision bulkhead forward and one at each end of engine space. The deck is flush, broken only by a low trunk over the owner's stateroom. The deck house is 18 feet long, serving as a social hall and dining-room, a dumb waiter leading to the galley below. The crew is berthed in the bow, then comes the captain's room, galley and engine space. Aft this there are four staterooms so arranged with a folding bulkhead between them that they may be thrown into one large room the full

width of the yacht. The saloon is 15 feet long, furnished in the usual way for day use, but with folding berths and curtains by which it can be divided into four separate rooms. Aft of the saloon is the companion, with toilet-room to port, and a stateroom to starboard, while abaft all is the owner's stateroom, 10 feet long and extending full width of yacht, the low trunk giving ample light and head room and superior ventilation. The toilet-room is fitted with bath-tub, plumbed for hot and cold, fresh as well as salt water. The yacht is lighted by electricity. The engine is triple-expansion, the diameter of cylinders being 12 inches, 18 inches and two 20 inches, with a uniform piston stroke of 15 inches. The bed-plate is of cast steel. The cylinders are supported by eight 1 $\frac{1}{8}$ -inch steel columns, well connected and braced diagonally. All the moving parts are of steel, as light as due regard for strength as well as durability will permit. The bearings and pins are large so as to run perfectly cool under all conditions. The valve motion is taken from a parallel shaft, geared to main crank shaft, and the reversing is effected by means of a sleeve on a parallel shaft, one end with a straight slot working on a feather in one of the gear wheels, and the other end having a spiral slot working on a feather on parallel shaft. By moving this sleeve in and out the necessary angular advance is obtained for operating the valves. The latter are all piston valves, fitted with packing rings to make them tight. The condenser has a copper shell to save weight, and has 48258-inch tubes 5 feet long. Air and circulating-pumps are of standard make. The propeller is four-bladed, 4 feet 9 inches in diameter, of cast iron. The engine is carefully balanced and will be entirely free

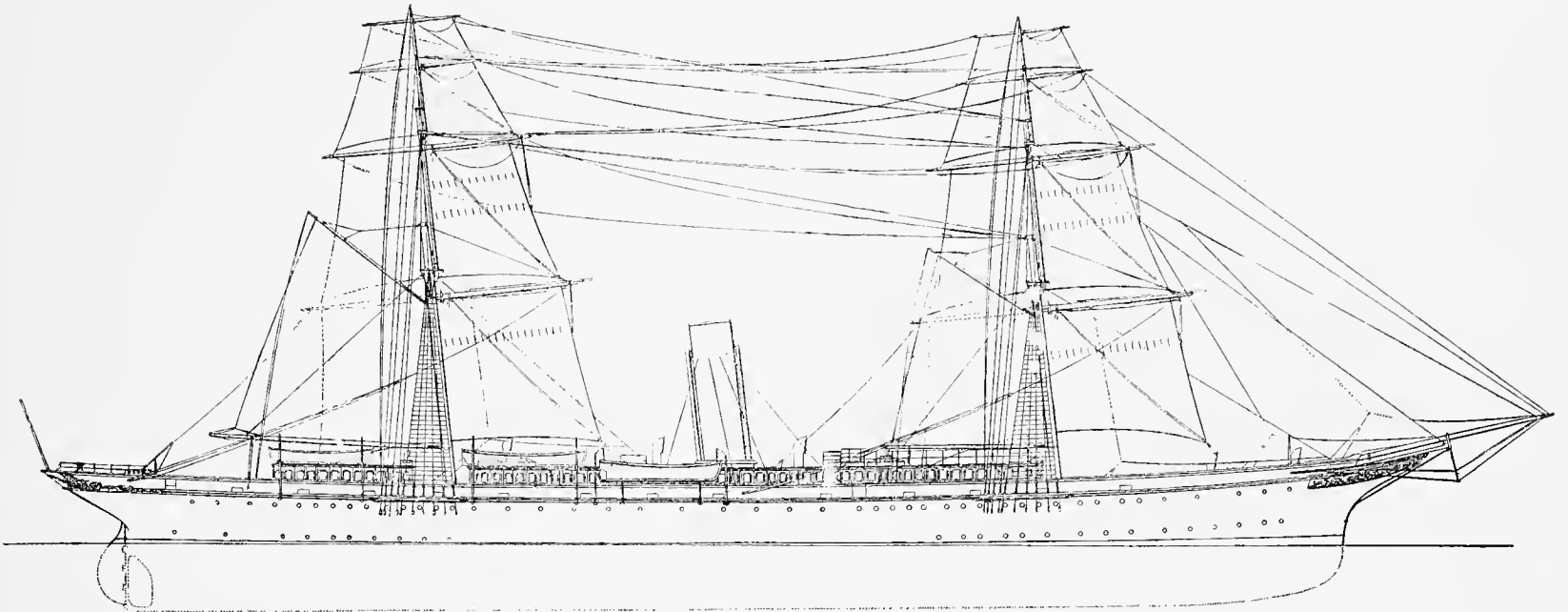

W. K. VANDERBILT'S TWIN-SCREW STEAM YACHT VALIANT.—Built by Laird Bros., Birkenhead, England.

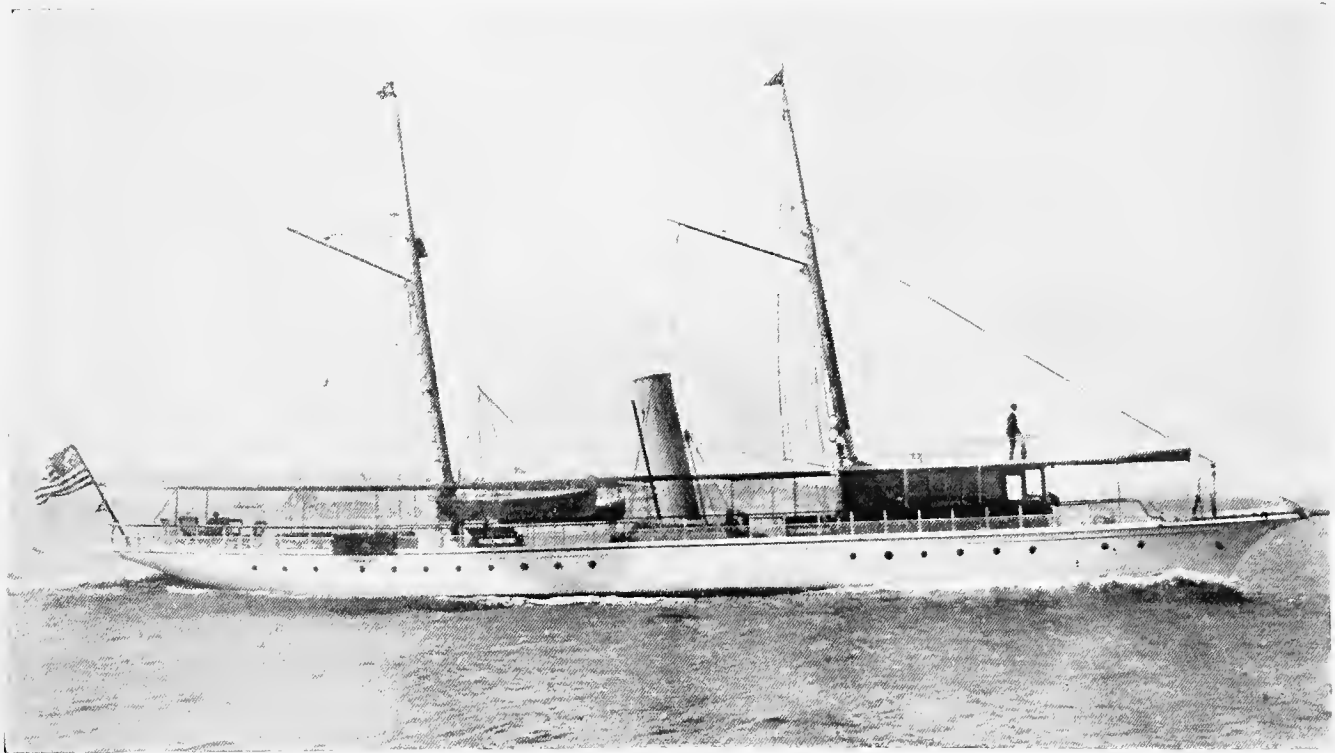

THE STEAM YACHT JUDGE, FORMERLY THE MARIETTA, No. 1

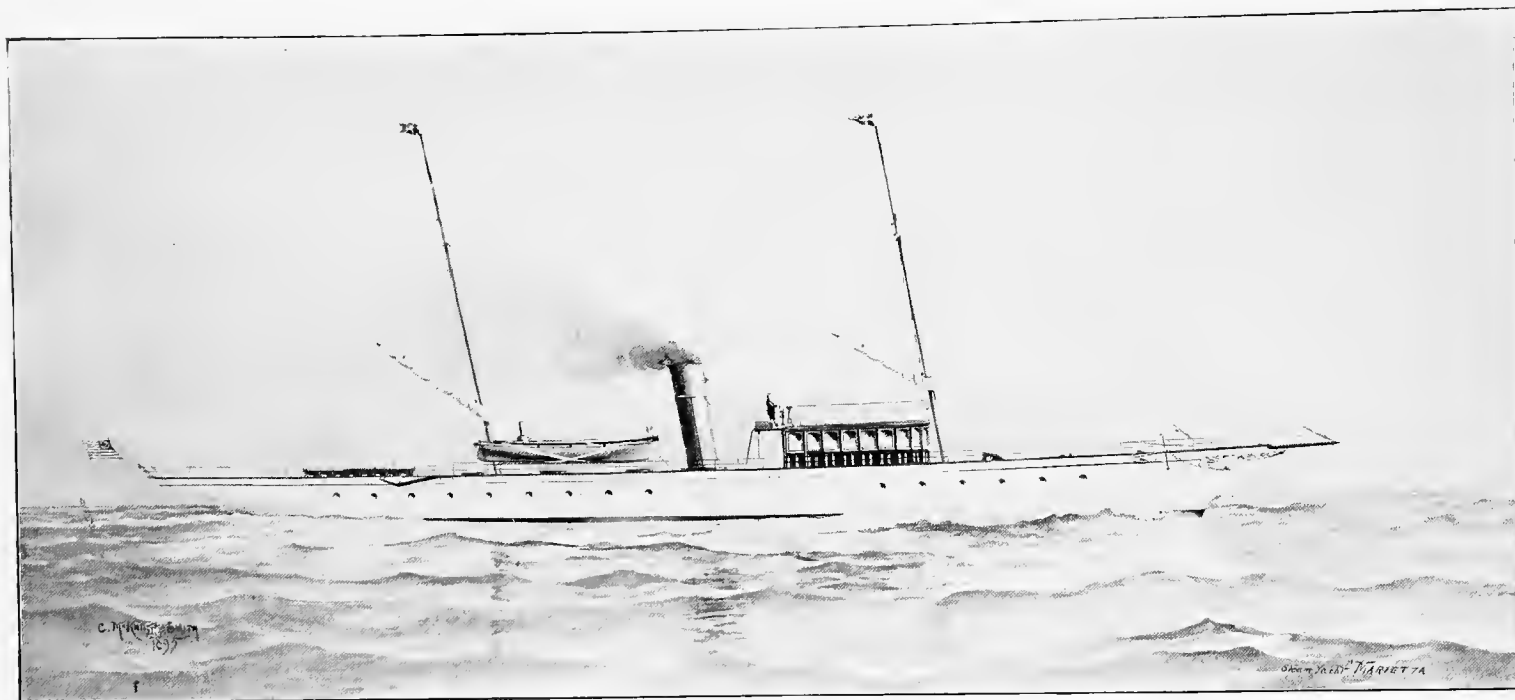

THE STEAM YACHT MARIETTA, NO. 2.

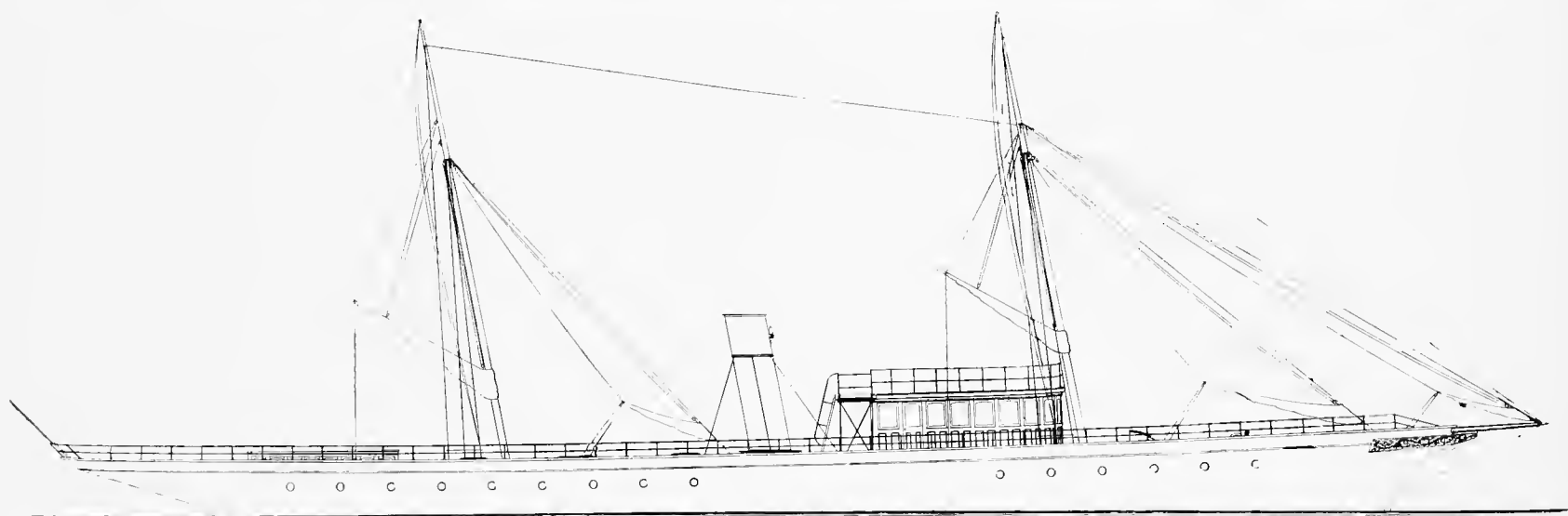

H. B. MOORE'S STEAM YACHT MARIETTA.—Built by the Pusey & Jones Co., Wilmington, Del., from Plans of Henry J. Gielow. (No. 2).

from vibration, making 310 revolutions ordinarily, but can be driven in excess of 350 revolutions per minute. The machinery was built by J. W. Sullivan. There are two Roberts water-tube boilers, 5 feet wide, 7 feet 9 inches long by 6 feet high, about 24 square feet of grate each, and about 800 square feet of heating surface each."

Auxiliary Steam Yacht Semiramis.

This vessel is of 703 tons register. She was designed by Alfred H. Brown, of London, for John Lysaght, and built by Ramage & Ferguson, Leith, Scotland, in 1889. She is of steel throughout. Her dimensions are as follows: Length between

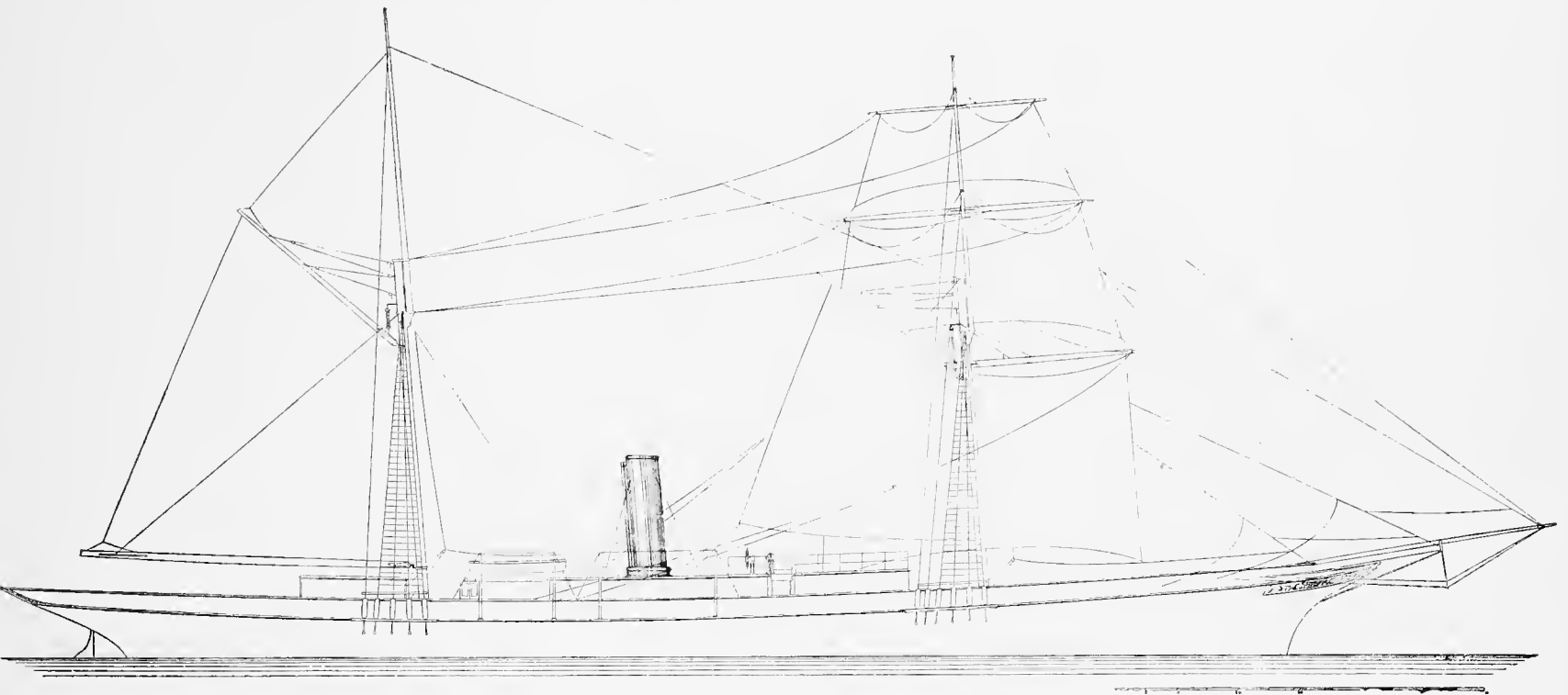

SAIL PLAN OF THE AUXILIARY STEAM YACHT SEMIRAMIS.

perpendiculars, 206 feet 4 inches; length, load water line, 194 feet; beam, extreme, 27 feet 1 inch, least freeboard, 6 feet; depth, moulded, 16 feet; depth, hold, 14 feet 6 inches; draft, extreme, 14 feet 6 inches. Her engines are triple-expansion; cylinders 18, 29 and 47 inches by 33 inches stroke, indicating 730 horse-power. Her bunker capacity is 150 tons, the consumption at 10 knots being 8 tons, while on 12 tons she has made a steady speed of 12 knots. It is expected that on long cruises she could easily steam 4,000 miles at 10 knots on her bunker coal. The total space given to the machinery is 47 feet 6 inches; engines, 15 feet; boiler, double ended, of steel, 160 pounds pressure, 27 feet, and athwartships bunker 5 feet 6 inches.

The Wooden Steam Yacht Chetolah.

This entire boat and machinery were designed and built at Newburyport for Capt. Chas. Lunt, a retired shipmaster of that place. Hull by L. Marquand, of Salisbury, and machinery by C. R. Sargent, Newburyport, Mass. Dimensions: Length, 110 feet over all, 89 feet water line, 16 feet 6 inches beam, and when ready for sea, with bunkers full of coal, draws 8 feet 6 inches. The crew are quartered aft. The motive power is a 500 horse-power triple-expansion engine, with cylinders 11½, 18, 30 inches by 16 inches stroke, all the cylinders being fitted with piston valves worked by a radial valve gear, each valve having an independent cut-off and the whole reversed by steam. The cylinders set on cast-iron columns with steel posts in front, giving a very open arrangement and easy of access to all parts of engine. The cast-iron columns carry the slides, which are cast with circulating passages for water. Crossheads are forged

solid with the piston-rods. Cranks set at 120 degrees and are "built up." Pins are 5¾ inches diameter by 6 inches long. Shaft, forged steel, 6 inches diameter, covered with brass. Wheel, 6 feet diameter, 9 feet 6 inches pitch. Steam is furnished by a Hodge upright tubular boiler 8 feet 9 inches diameter, 9 feet high. It has a double furnace with water leg between and 750 tubes 2 inches diameter and 6 feet long. Grate surface, 47½ square feet. Shell is ¾-inch Spang steel, butt and strap riveted. Working pressure 165 pounds. Cruising (for which the boat was especially designed), engine makes about 155 revolutions and 11 knots. This is found to be the most economical speed, all things considered. Under natural draught there is no trouble in running engines to 200 revolutions, which shows 12¾ knots by log.

The Wooden Steam Yacht Reverie.

This vessel was designed several years ago by Gustav Hillmann, the well-known and veteran naval architect of Brooklyn, N. Y., who designed J. J. Astor's magnificent iron steam yacht Nourmahal. The Reverie was built by Samuel H. Pine, Greenpoint, L. I., for the late Samuel G. Wilcox, but was afterward sold to Fred. G. Bourne, of New York. The yacht is 110 feet long on the water line, 16 feet 8 inches beam, and 8 feet 7 inches deep, and draws 6 feet of water; her registered tonnage is 92.15 tons gross and 53.48 tons net. The machinery was built under the supervision of the Babcock & Wilcox Company, of New York, and consists of an inverted condensing triple-compound engine, with cylinders 11, 16½ and 26 inches diameter by 12 inches stroke, using 225 pounds pressure. The



THE WOODEN STEAM YACHT CHETOLAH.—Built for Captain Chas. Lunt, of Newburyport, Mass.

cylinders are fitted with piston valves throughout, having one high-pressure, two intermediate and three low. There is a Baird evaporator, with its pump capable of evaporating 400 gallons of water in 24 hours, a duplex pump $5\frac{1}{4}$ by $3\frac{1}{2}$ by 6 inches, and an injector for feeding the boiler. The steam is supplied to all these auxiliaries and the main engine by one Babcock & Wilcox marine water-tube boiler, 10 feet 6 inches long, 7 feet wide and 9 feet 7 inches high, constructed entirely of wrought iron and steel, there being no cast or malleable iron whatever entering its construction. The following gives the essential particulars relating to the boiler: Heating surface, 1,235 square feet; grate surface, 40 square feet; ratio of heating surface to grate surface, 31 to 1; weight of boiler (dry), 20,515 pounds; weight of boiler (wet), 26,084 pounds; weight of boiler per square foot of heating surface (dry), 16.16 pounds; weight of boiler per square foot of heating surface (wet), 21.12 pounds. During a test of the boiler for capacity, 506 horse-power (one horse-power being equal to 15 pounds of water evaporated into dry steam, triple-compound engine practice) was easily developed for eight hours of continuous steaming. This is equivalent to 12.6 horse-power per square foot of grate.

The Steam Yacht Oneonta.

This craft was designed by Gardner & Co., New York, and built in 1895 at the Delaware River Iron Shipbuilding & Engine Works, Chester, Pa., for F. C. Dinniny, of this city, and is a departure in many ways from the ordinary type of

steam yacht, being designed with a view to both comfort and speed. Her dimensions are: Length over all, 140 feet; load water line, 132 feet; beam, 19 feet 6 inches; draught, 7 feet. She is fitted with a water-tube boiler of the Daring type, of about 2200 square feet of heating surface and 55 square feet of grate, built of selected material to stand 600 pounds. A peculiarity of this boiler being that no rivets are used, the drums being welded up by the Continental Iron Works, and thus all danger of leakage due to expansion of joints, caused by the high pressure used in this type of boiler, is prevented. The engine is of the triple-expansion type, three cylinders 15, 23, 35 by 16 inches; indicated horse-power, 1000; revolutions, 400 per minute. This engine is balanced by Normand's method of placing the low-pressure cylinder in the center, and thus avoiding the severe racking couple that results when the revolutions coincide with the period of vibration in the ordinary type of marine engine. The auxiliary machinery is independent, except the air-pump, which is direct. Forced draught on the closed fire-room principle is installed, but seldom used, as sufficient steam for ordinary running can be secured by natural draught. The Oneonta, in a trial run, covered 100 miles in 5 hours and 6 minutes, or nearly 20 miles an hour, which is not bad when it is considered that the yacht is not built as a flyer, but has as much room as any yacht of her size afloat. The hull of the boat is of steel up to Government standards in every particular; flush decked with large dining saloon forward and ladies' deck house aft. In appearance the Oneonta resembles a Government despatch boat, and the effect, while odd, is not displeasing.

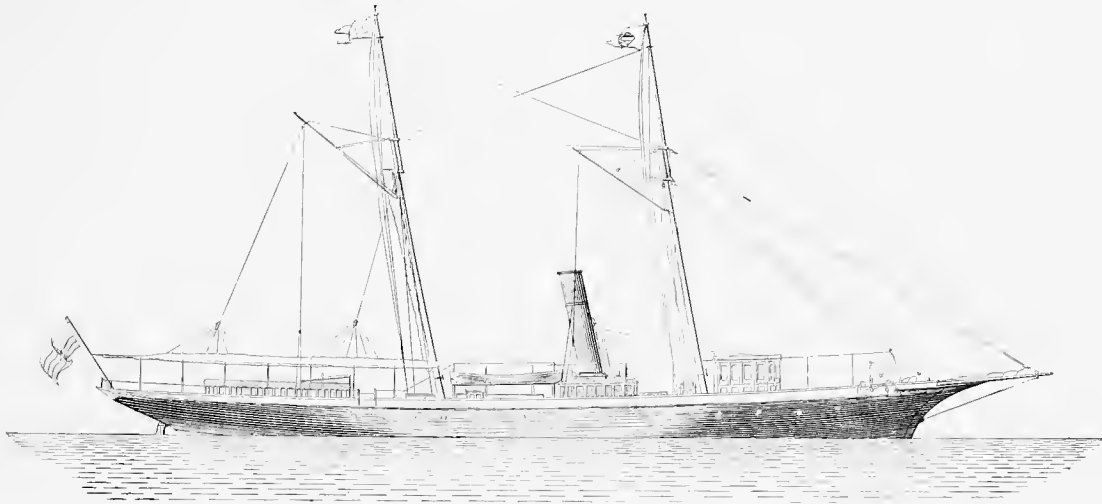

WOODEN STEAM YACHT REVERIE,--Fitted with a Babcock & Wilcox Water-Tube Boiler.

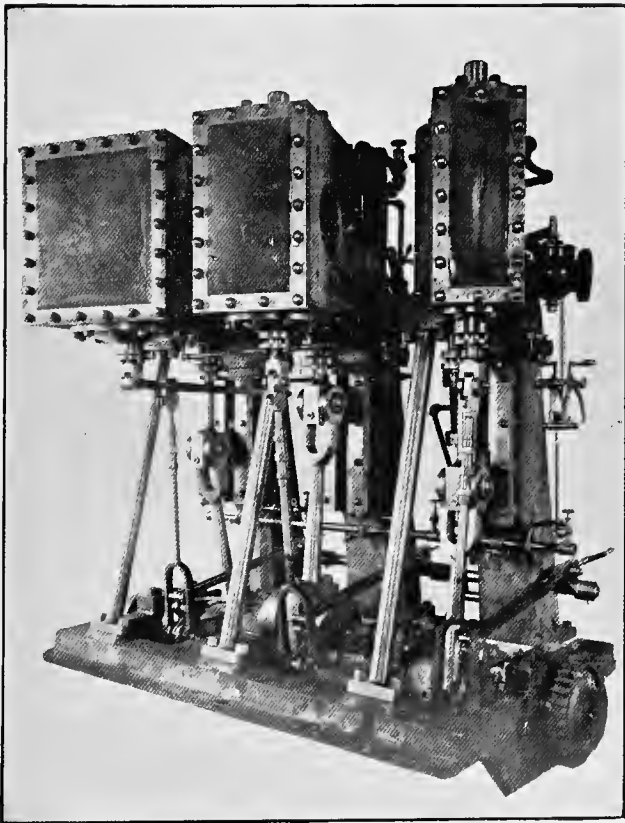

TRIPLE-EXPANSION ENGINE OF THE WOODEN STEAM YACHT CHETOLAH.



STEAM YACHT ONEONTA. --Constructed at the Delaware River Iron Shipbuilding and Engine Works, Chester, Pa.

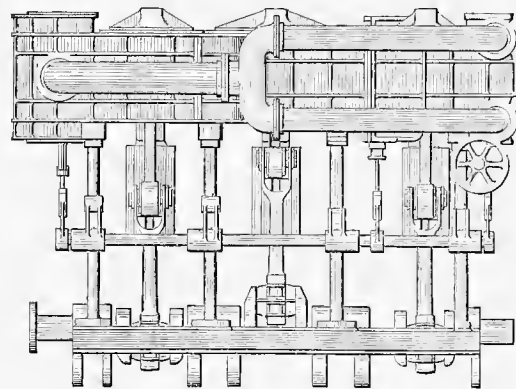

ENGINE OF STEAM YACHT ONEONTA.

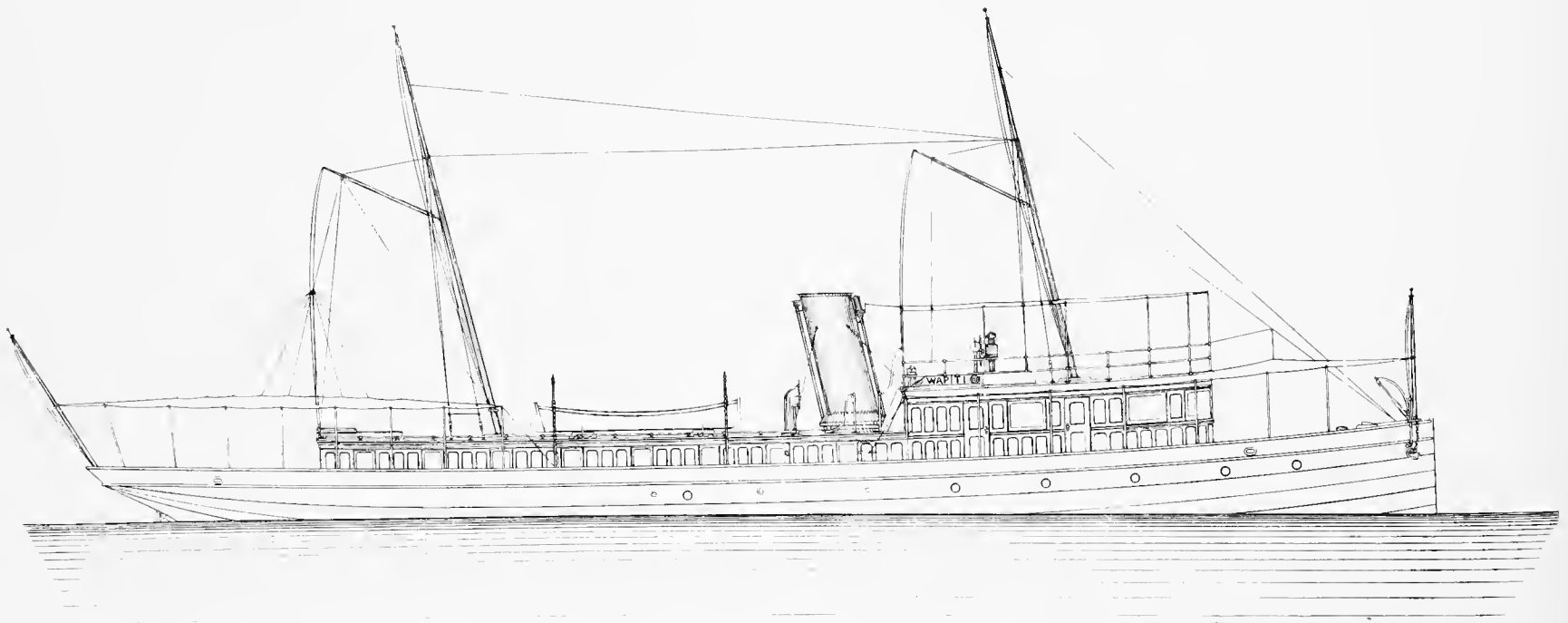
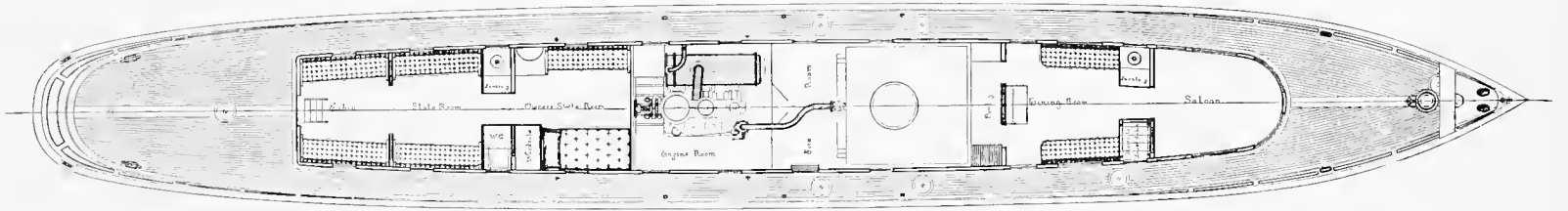
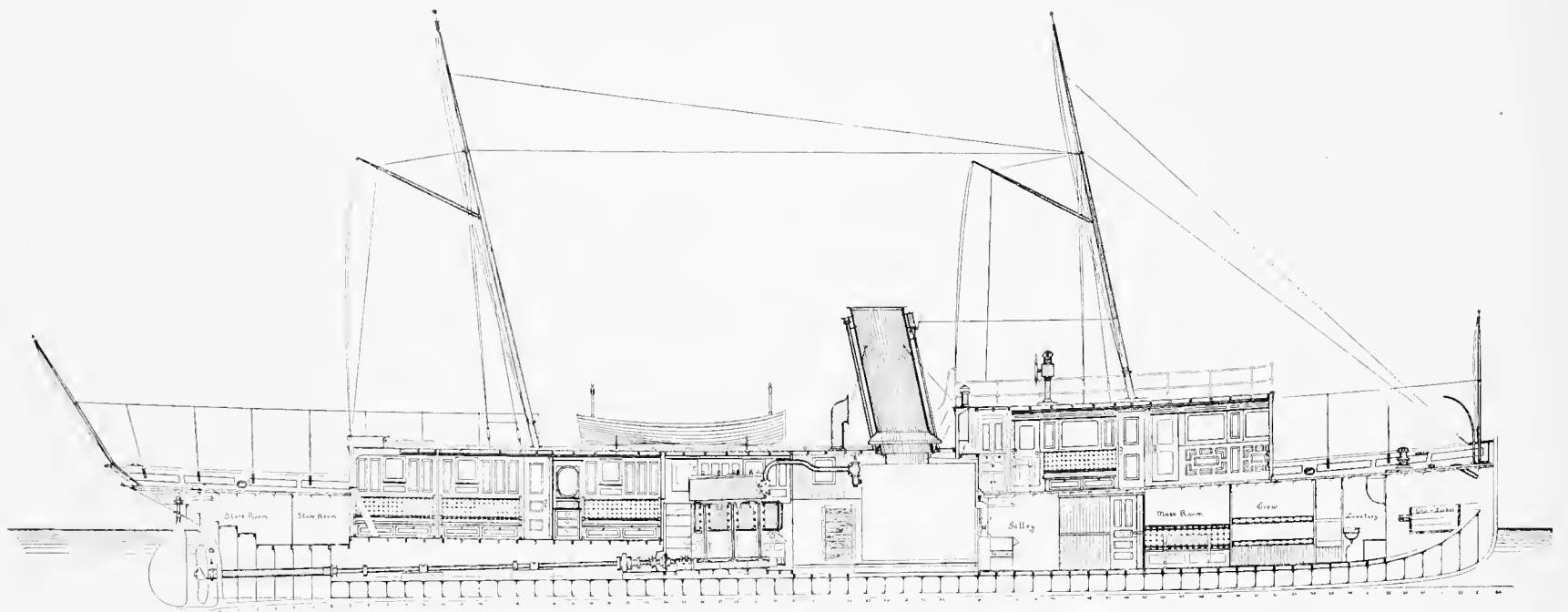

STEAM YACHT WAPITI.—Built by F. W. Wheeler & Co., West Bay City, Mich., for Isaac Bearinger, of Saginaw, Mich.

-Triple Expansion Engine-
 -9'-14'-23" x 14'-
 -F. W. Wheeler & Co. West Bay City-
 -June 1894. -Scale 1/2" = 1 foot.-
 S. Anderson M. E.

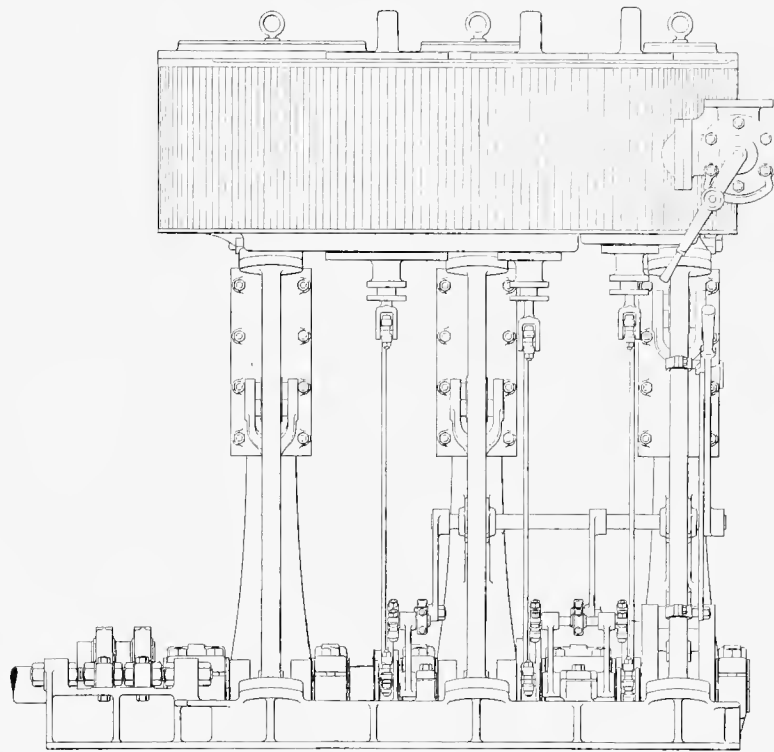
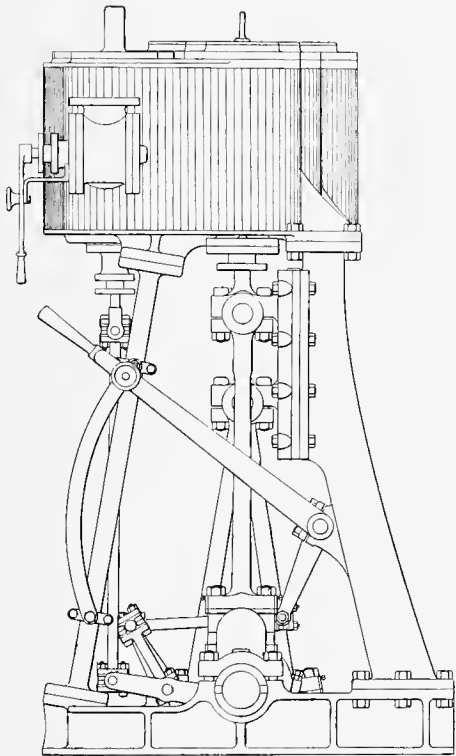
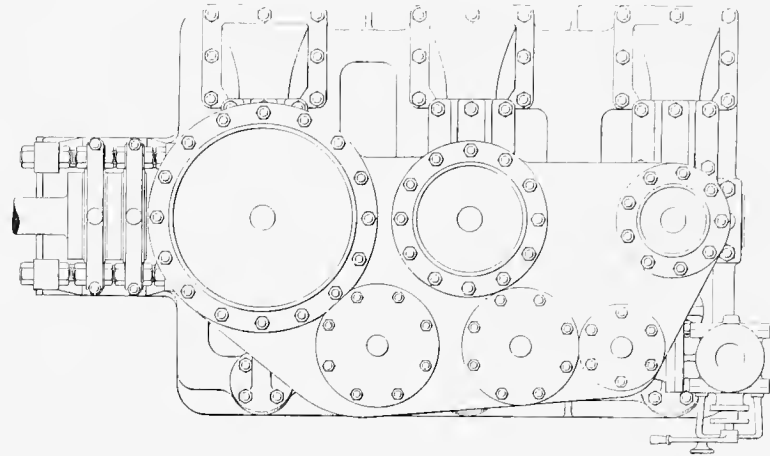

TRIPLE-EXPANSION ENGINE OF ISAAC BEARINGER'S STEAM YACHT WAPITI.

Steam Yacht Wapiti and Her Engines.

One of the handsomest up-to-date yachts on the great lakes, the Wapiti, was completed in July, 1895, at the shipbuilding yards of F. W. Wheeler & Co., West Bay City, Mich. She replaces for Isaac Bearinger, of Saginaw, Mich., his old yacht of the same name. The Wapiti is a steel yacht of the following dimensions: Length over all, 106 feet 6 inches; length on water line, 98 feet; beam, moulded, 14 feet 4 inches; depth, moulded, 7 feet. The hull is built of mild steel having tensile strength of from 55,000 to 60,000 pounds per square

inch. The weight of shell plating is from 10 to 12 1/2 pounds per square foot. Frames are spaced 17 inches from center to center, and are steel angles 2 1/2 by 2 1/2 by 5 pounds per foot. The floor plates are 15 inches deep and weigh 10 pounds per square foot. There is a reverse bar on top of floors 2 1/2 by 2 1/2 by 4 pounds per square foot. A continuous center keelson made of two angles 4 by 3 by 12 pounds per foot, riveted back to back and strongly connected to reverse frames, runs the entire length of vessel. These are also three keelsons running the full length of boat of 3 by 3 by 8 pound angles riveted back to back. The bulkwarks are of steel and paneled inside with

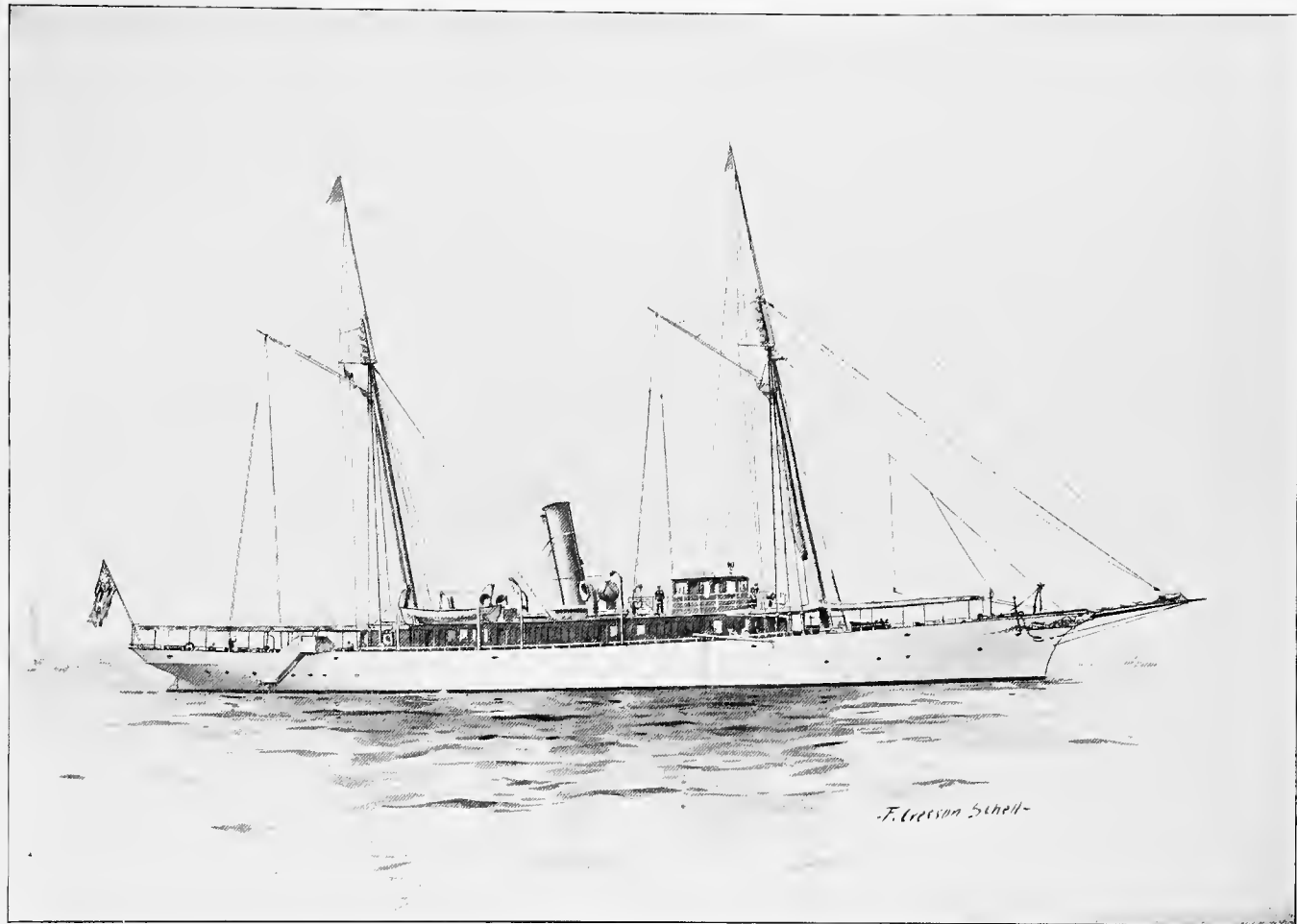

STEAM YACHT COLUMBIA.—Built by Wm. Cramp & Sons, for J. Harvey Ladew, of New York.

mahogany. All the woodwork above deck, including cabins, bulwarks and seat is of mahogany, with the exception of the rail, plank shear and house coamings, which are of teak. The two pole spars are of white pine and very light, and step on top of cabins so as not to occupy valuable space in cabins. The motive power consists of a triple-expansion engine with cylinders 9, 14 and 23 by 14 inches, driving a Trout wheel 4 feet 6 inches diameter and 6 feet 6 inches pitch. In order to take up as little fore-and-aft space as possible, the valves, which are all piston type, were put on the side of cylinders and operated by Marshall radial gear. The cylinders are placed in the order of high, intermediate and low. The bedplate is cast iron of the girder type, with five main journals and a thrust bearing of the horseshoe type with two collars cast on. The crank shaft is solid forged with cranks at 120 degrees apart, in the following order: Intermediate, high-pressure and low-pressure. All working parts are made as light as possible with all rods and bolts of machinery steel. All main journals and crank-pin brasses are lined with anti-friction metal. The general style of the engine, which is designed for a piston speed of 950 feet per minute, is very clearly shown by the engraving. The sur-

face condenser is a special style made by Dean Bros., of Indianapolis, Ind., with combined air and circulating-pumps. The brass tubes in condenser are $\frac{5}{8}$ inch diameter and 6 feet long, giving a cooling surface of 385 square feet. The diameter of air-pump is 9 inches, circulating-pump 9 inches, and steam cylinder 7 inches, with a common stroke of 10 inches. The total weight of the condenser and pumps is 4800 pounds. Steam is supplied by a Roberts safety water-tube boiler, 8 feet 8 inches long, 8 feet 5 inches wide and 8 feet 4 inches deep. It contains two furnaces 3 feet 8 inches wide by 7 feet long, with grates for burning anthracite coal. The steam pressure allowed is 300 pounds per square inch, and at this pressure, with the engine making 350 revolutions per minute, a speed of 16 miles per hour is obtained. A special feature in connection with the machinery is a patent universal roller thrust bearing, made by Michael Schmaltz, of West Bay City, Mich. This bearing consists of eight conical rollers running between two cast-steel discs, as will readily be seen by the accompanying illustration. All parts of this bearing are well adjusted and the friction is reduced to a minimum, thus tending to increase the number of revolutions of the engine considerably more than when the

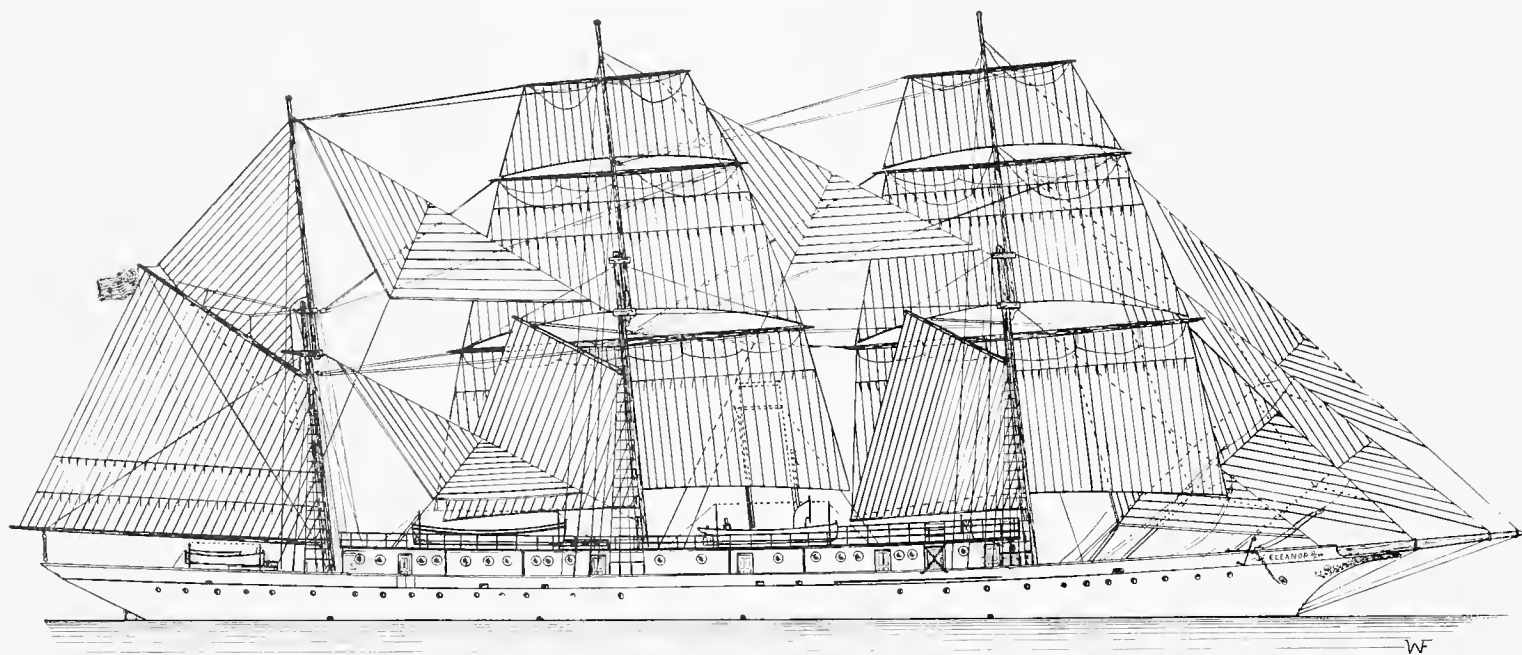

THE AUXILIARY STEAM YACHT ELEANOR.—Built by the Bath (Maine) Iron Works, for Wm. Slater, of Norwich, Conn.

horseshoe design is used. The Wapiti's straight stem and low freeboard gives her the appearance of an ocean steamer. The vessel and her machinery were built from designs of S. Anderson, chief engineer with F. W. Wheeler & Co.

Steam Yachts Built by Wm. Cramp & Sons.

Though steam yacht building is not usually a profitable part of the work of a shipyard, the Cramp Company has from time to time undertaken the construction of vessels of that character. The most important of these yachts are enumerated: The Corsair (since renamed the Kanapaha) and the Stranger were built in 1880, and delivered to their owners, Messrs. Charles J. Osborn and George Osgood, of New York, in July of that year. They were substantially sister ships, having the same principal dimensions and type of machinery, with only minor differences in trim and interior fittings. They have been constantly in use during the 14 years of their existence, performing satisfactory service to their owners at extremely small cost of overhaul and repair. Their dimensions are as follows: Length, 165 feet; extreme beam, 23 feet; draught of water, Corsair, 8 feet; Stranger, 9¹/₄ feet; displacement at that draught, Corsair, 258 tons; Stranger, 330 tons. They are powered with two-cylinder vertical inverted compound engines, having high-pressure cylinders 24 inches and low-pressure 44 inches diameter with 24 inches stroke. They are each provided with a pair of single-ender boilers 11 feet diameter by 10 feet 6 inches long, and carrying steam at 80 pounds this motive machinery developed 600 indicated horse-power on trial, and produced a speed of 13¹/₂ to 14 knots. The next important steam yacht built by Cramp was the Atalanta, delivered to Jay

Gould in June, 1883. This yacht was subsequently lengthened and her power increased. Her dimensions, as lengthened, were as follows: Length on water line, 228³/₄ feet; extreme beam, 26¹/₂ feet; mean draught of water, 10 feet 2 inches; displacement at that draught, 617 tons. The Atalanta is propelled by a two-cylinder vertical compound engine, with cylinders respectively 30 and 60 inches diameter and 30 inches stroke. Steam is supplied by a pair of double-ender return tube boilers 13 feet 4¹/₂ inches diameter by 14 feet long. The maximum indicated horse-power developed by the Atalanta's machinery occurred during the memorable steam yacht race in Long Island Sound in 1886. It was 1,540, and gave her a mean speed of 17.3 knots over a course 80¹/₂ knots in length. Subsequently Mr. Gould made several extended cruises in her, on one occasion visiting the Levant as far as Constantinople. She has remained in the possession of his children since his death. In 1885 the Cramp Company decided to make a practice trial of the principle of triple-expansion, and not being at that moment able to induce any of their commercial customers to undertake the innovation in a ship, they built a steam yacht known for some time by her shipyard number "246," but subsequently, when sold to Charles W. Harkness, of Cleveland, Ohio, christened the Peerless. Being powered with one of the first triple-expansion engines built in America, and the development of that type being in its infancy elsewhere, the performance of "Number 246" was watched with great interest by the engineering profession. Her dimensions are: Length on the water line, 152 feet 7 inches; extreme beam, 22 feet; mean draught of water, 8 feet 2 inches; displacement at that draught, 260 tons. Her triple-expansion engine is vertical, three cylinder; high-pressure 17 inches, intermediate 24 inches and low-pressure 40 inches diameter with 22-inch stroke.

Steam is supplied by one cylindrical boiler 12 feet 10 inches diameter by 12 feet long. The working pressure is 180 pounds, and the resultant maximum indicated horse-power developed in the yacht race already referred to was 816, producing a maximum speed of 17.4 knots per hour under forced draught. It is worthy of note that this early application of triple-expansion in America was made with a steam pressure 20 pounds greater than has since been employed here, and 50 pounds greater than had been attempted up to that date abroad. After remaining in possession of the Cramp Company about two years, the Peerless went into service on Lake Erie, where she has since held the record for speed over all pleasure craft, and until very recently over the entire steam fleet of the Great Lakes. In fact, she is excelled in speed now only by the very latest and largest passenger steamers in those waters. During the year following the advent of the Peerless, a pressure of naval and commercial work caused the Cramp Company to decline a number of proposals for steam yachts, until in 1893, J. Harvey Ladew, of New York, expressed a desire to own the fastest pleasure vessel afloat. The result was the beautiful little vessel represented in the picture and known as the Columbia. Her dimensions are: Length on load water line, 180 feet; length over all, 202 feet; extreme beam, 23 feet; mean draught (cruising trim), $10\frac{3}{4}$ feet; displacement at that draught, 526 tons; probable best racing draught, $9\frac{1}{2}$ feet; displacement at racing draught, about 436 tons. She is powered with a four-cylinder triple-expansion engine, cylinder diameters respectively, high-pressure $21\frac{1}{2}$ inches, intermediate-pressure 31 inches, and two low-pressure 44 inches each. Steam is supplied by two single-ender return tube boilers 12 feet 2 inches diameter by 11 feet 5 inches long, with a working pressure of 160 pounds, and developing under forced draught a maximum of 1,900 indicated horse-power. The Columbia having been made ready for trial, left Cramp's yard for New York, and on Tuesday, December 19, 8:25:41 A. M., Mr. Flagler's house, at Larchmont, L. I., bearing directly abeam, she started on trial over the New York Yacht Club course from Larchmont to the Pequot House, New London, distant 80.52 knots, which she reached at 12:56:24. The mean speed was 17.85 knots equal to 20.53 statute miles an hour. During this run, between two intermediate points, namely, Stratford Shoal Light and Falkner's Island, a distance of 22 knots, her speed was 18.35 knots. This was due to the deep water in that part of the course, the depth in other parts not being sufficient to prevent dragging to some extent. At a mean speed of 18 knots this vessel requires a depth of water at least fifteen times her own draught to avoid dragging. In view of the difficulties of the course and the fact that the yacht, when in water of sufficient depth to give her a fair chance, exceeded 18 knots, she was promptly accepted by her owner.

The Steam Yacht Eleanor.

The Bath (Maine) Iron Works built the steam yacht named Eleanor, to the order of William A. Slater, of Norwich, Conn. The Eleanor was designed by Chas. R. Hanscom. The principal dimensions of the Eleanor are: Length over all, 231 feet; length, load water line, 208 feet; length, keel, 185 feet; beam, extreme, 32 feet; depth of hold, 17 feet 5 inches; mean draught, 13 feet 4 inches; displacement, 1,136 tons. She is con-

structed of steel throughout. The propelling power consists of a vertical inverted direct acting triple-expansion engine, with cylinders 18, 28 and 45 inches diameter by 30 inches stroke. Steam is supplied by two steel Scotch boilers, each 12 feet $6\frac{1}{2}$ inches long and 12 feet 5 inches diameter. The total grate surface 120 square feet, and the working pressure 165 pounds. The propeller is three-bladed, 10 feet $4\frac{1}{4}$ inches diameter and 11 feet 6 inches to 12 feet pitch. The area of her principal sails is 10,935 square feet. The following are the dimensions of her spars: Length of mizzen mast, deck to hounds, 43 feet 6 inches; mainmast, deck to hounds, 51 feet; foremast, deck to hounds, 49 feet; mizzen topmast, including topgallant, 46 feet 6 inches; main topmast, including topgallant, 53 feet 4 inches; fore topmast, including topgallant, 54 feet 4 inches; spanker boom, 56 feet; spanker gaff boom, 34 feet 6 inches; main gaff, 18 feet; fore gaff, 18 feet; bowsprit, 48 feet 6 inches; bowsprit outboard, 34 feet 6 inches; fore yard, 64 feet; main yard, 64 feet; fore topsail yard, 48 feet; main topsail yard, 48 feet; fore topgallant yard, 33 feet; main topgallant yard, 33 feet.

The Steam Yacht Rex.

This fast wooden steam yacht was designed and built by L. Boyer's Sons, New York. Her dimensions are: Length over all, 64 feet; water line, 59 7-12 feet; beam, $7\frac{1}{2}$ feet; depth, $4\frac{1}{2}$ feet; extreme draft at wheel, 3 feet. The keel is of white oak. Frames are of steam-bent white oak, placed six inches between centers with hackmatack floor frames, fastened through keel and keelson with brass screw bolts. The motive power is a triple-expansion engine of 5, $8\frac{7}{8}$, $13\frac{3}{8}$ inches diameter of cylinders and 9-12-foot stroke of piston. The engines throughout are carefully and accurately fitted, perfectly balanced, and have been run 1,000 revolutions per minute, making 1500 feet piston speed a minute, which is the highest ever attained by a marine engine. There is practically no vibration. The boiler, of the Boyer water-tube type, is made of wrought-iron tubes, screwed together in sections, has no joints directly attacked by the heat from the furnace, is provided with a steam drum of steel plate double riveted, which is entirely removed from the heat of the furnace. It was subjected to 650 pounds hydrostatic pressure, and is allowed 300 pounds of steam pressure. It is a great economizer of fuel, 2,000 pounds of coal being sufficient to cruise the Rex from 150 to 175 miles at natural draught.

The Three Fastest Steam Yachts.

The small yachts shown running abreast have developed remarkable speed. The figures published herewith were all furnished by Chas. D. Mosher.

The Feiseen was built for W. B. Cogswell, of Syracuse, N. Y., and was launched in the spring of 1893. She was afterward sold to the Brazilian Government and fitted up as a torpedo boat. This boat has a record of 31.6 miles per hour, having covered a distance of $7\frac{1}{4}$ miles in 13 minutes and 45 seconds against a slight tide. Her dimensions are: 85 feet long, 9 feet 8 inches beam and 3 feet 6 inches draught. The hull is of composite construction, the keelsons, part of the frames and bulkheads being of steel.



THE HIGH-SPEED WOODEN STEAM YACHT REX.—Designed and built by L. Boyer's Sons, New York.

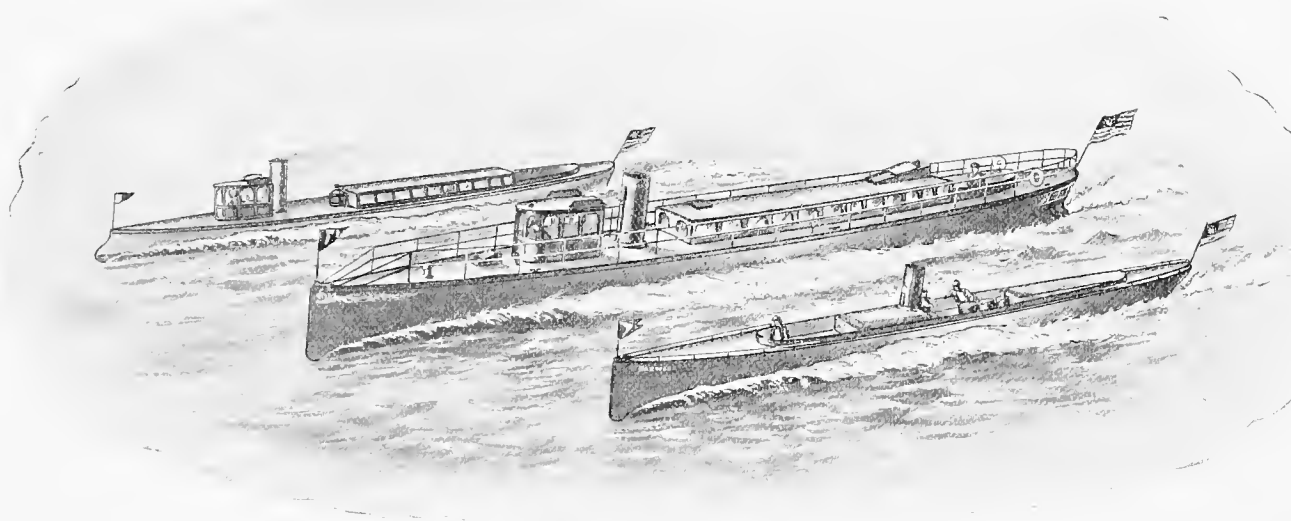

YANKEE DOODLE,
29.6 miles per hour.

FEISEEN,
31.6 miles per hour.

NORWOOD,
30.5 miles per hour.

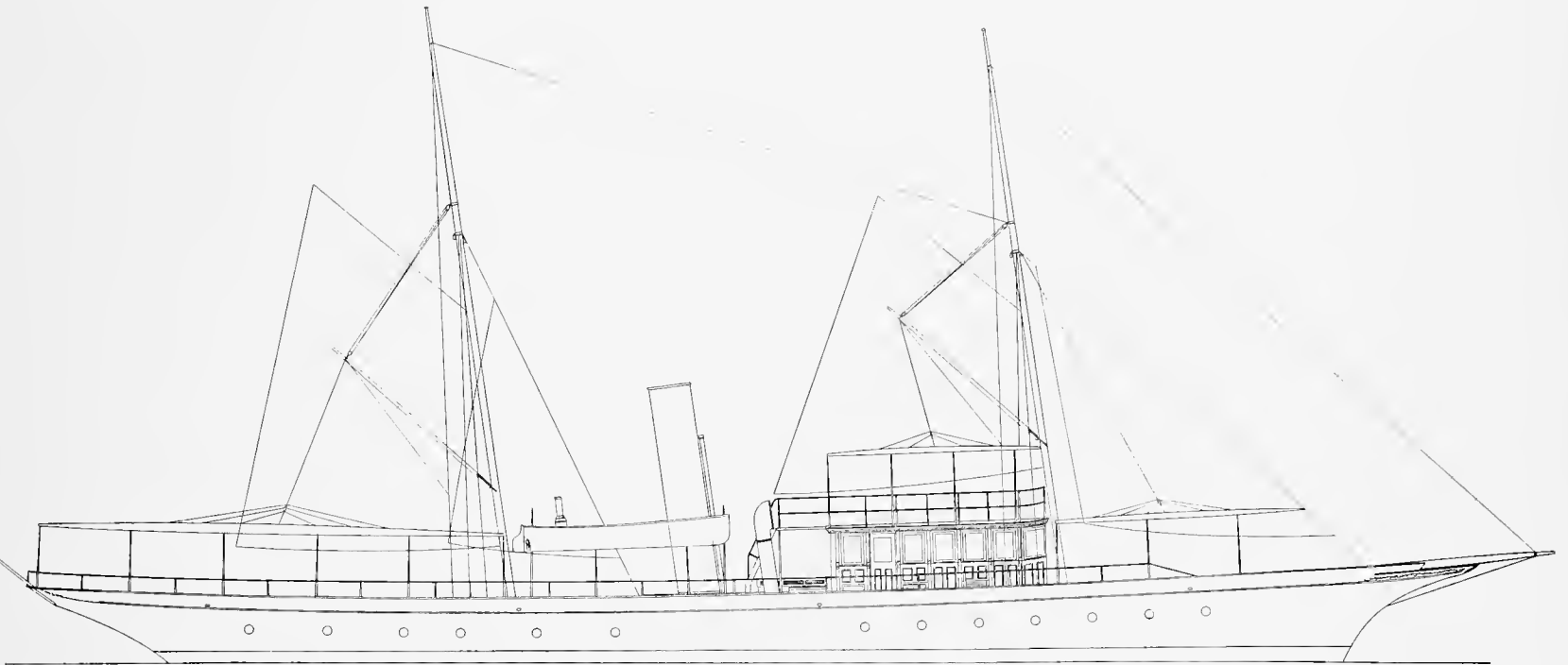

SHEAR PLAN OF THE COMPOSITE STEAM YACHT ALCEDO.

The machinery consists of a Mosher patent quadruple-expansion engine, having cylinders $9\frac{1}{2}$, $13\frac{1}{2}$, 18 and 24 inches in diameter by 10 inches stroke, it having developed 600 horse-power when making about 600 revolutions per minute under a working pressure of 250 pounds per square inch. The boiler is of the Mosher water-tube type, with 1200 square feet of heating surface and 33 square feet of grate surface, and allows a working pressure of 275 pounds per square inch.

The Norwood was launched in the spring of 1890, having been built for the late Norman L. Munro. This boat is an open launch, 63 feet long, 7 feet 3 inches beam and 3 feet draught of water. She has a cockpit forward and one aft, each 10 feet long. She is decked over for a distance of 12 feet forward and 10 feet aft.

In a series of runs over the measured mile course of the Wamesquam Boat Club, on the Merrimac River, in slack water, she developed a mean speed of 30 miles per hour, having covered the course during this trial at a rate of 30.5 miles per hour.

The engine is of the Mosher triple-expansion type, having cylinders 9, $14\frac{1}{2}$ and 22 inches diameter by 9 inches stroke, which has indicated 450 horse-power when making about 560 revolutions per minute. The engine is provided with an inboard surface condenser, independent air and feed-pumps and blower engines for forced draught. The boiler is of the Mosher water-tube type, with a working pressure of 275 pounds, having 800 square feet of heating surface and 24 square feet of grate surface.

The Yankee Doodle, originally known as the Buzz, was built in the season of 1888-9 for Mr. Mosher's own use. She is a trunk cabin launch, 50 feet long, $6\frac{1}{2}$ feet beam and 30 inches draught of water. This launch attained a speed of 29.6

miles per hour, which record was made during a race on July 4, 1892, on the Schuylkill River, in slack water, over a measured mile course, which was covered in 2 minutes 13.5 seconds. The engines consist of a pair of simple high-pressure direct acting, each with cylinders 8 inches in diameter and 8 inches stroke, having indicated 194 horse-power when making 722 revolutions per minute, with a steam pressure of 150 pounds. The boiler has 300 square feet of heating surface and 8 square feet of grate surface. The Buzz and Norwood were built at Amesbury, Mass., by Chas. D. Mosher, Engineer and Naval Architect, New York. The Feiseen was designed by Wm. Gardner; her engine was built by L. Wright, Jr., of Newark, N. J., and the hull by A. B. Wood & Sons, City Island, N. Y.

The Steam Yacht Alcedo.

The Alcedo is a flushed-deck steam yacht of composite construction, built in 1895, by George Lawley & Son, City Point, South Boston, Mass., from plans of Waterhouse & Chesebrough, Boston, Mass., and under their supervision, for Geo. W. Childs Drexel, of Philadelphia, Pa. The general dimensions of the yacht are as follows: 124 feet over all, 102 feet load water line, 16 feet 2 inches beam, 6 feet 6 inches draught. The hull is subdivided into five compartments by four steel water-tight bulkheads. The construction is of rather more than usual strength for a vessel of her size. The hull is stiffened by a system of steel straps worked diagonally over the frames and deck frames. The planking of the hull is of Georgia pine, $2\frac{3}{8}$ inches thick. A peculiarity in the arrangement of this yacht is that the engines are forward of the boiler, which fact enables a gain of a

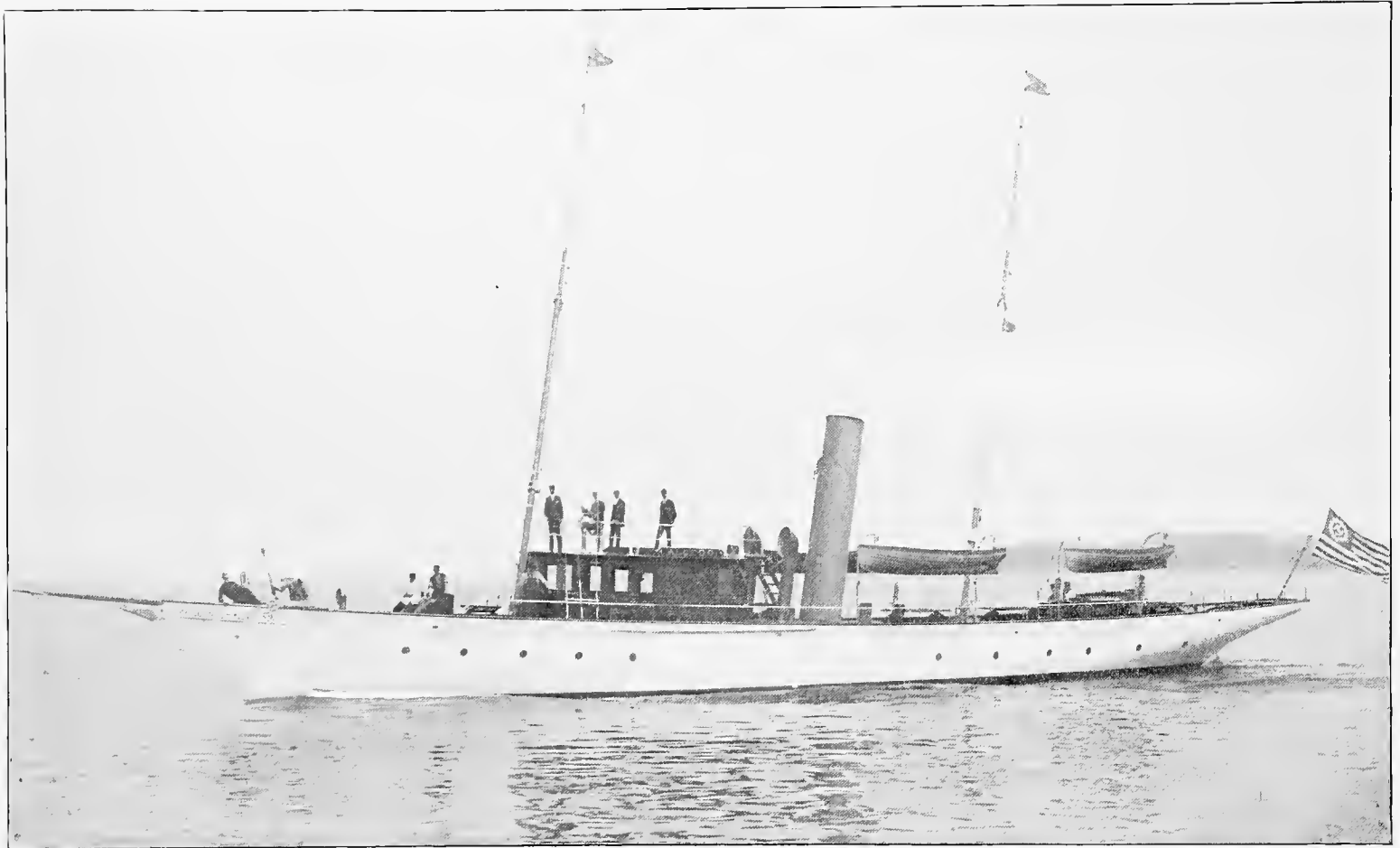

G. W. C. DREXEL'S NEW STEAM YACHT ALCEDO.—Designed by Waterhouse & Chesebrough. Built by Geo. Lawley & Son.

considerable amount of after-cabin accommodation, owing to the weight of the boiler and coal being in the after end of the machinery space, rather than the forward end, as is the usual arrangement of a yacht of this size. Directly aft of the machinery space and separated from it by a steel water-tight bulk-head, and protected from the heat of the boiler and the noise of the fire-room by an across coal bunker, is the owner's state-room. The machinery consists of a triple-expansion engine of $9\frac{1}{2}$, 15 and $24\frac{1}{2}$ inches diameters with a stroke of 13 inches, built by the Fore River Engine Co., of Weymouth, Mass. Steam is furnished by a double fire box water-tube boiler of the Almy type, licensed to carry a pressure of 250 pounds to the square inch. The circulating, air, feed and bilge-pumps are all independent and are arranged to exhaust into the low-pressure receiver of the condenser. Pistons are of cast steel with spring rings as lightly constructed as is consistent with strength; valves of cast iron of piston type. They are actuated by a side crank shaft driven from main shaft by steel and raw-hide gears. The reverse is accomplished with a spiral sleeve, working on a spiral on side shaft. The spirals and sleeves are

cut from the solid steel, making a compact and durable piece of mechanism. The engine runs without the slightest vibration, and turns a bronze, four-bladed propeller, 5 feet diameter 7 feet pitch, 320 revolutions per minute, with 200 pounds steam. The condenser is 6 feet long, 36 inches diameter, copper shell, brass heads and tubes, contains 650 feet cooling surface. The coal bunkers have a capacity of 18 tons.

SNELLING'S COMBINED HAND STEERER AND ENGINE-ROOM TELEGRAPH.

Among the novel features in the bridge fixtures of the Alcedo is the steering apparatus and engine-room telegraph. They are combined in a manner which affords great convenience to the wheelsman, permitting him to operate either of them without moving from his position. The device was designed by J. H. Snelling, of the Marine Manufacturing and Supply Co., 158 South Street, New York, which company constructed the machine. The steering apparatus is the well-known Snelling steerer, used generally on yachts of this class, but modified to suit the special conditions required. On top of it is mounted

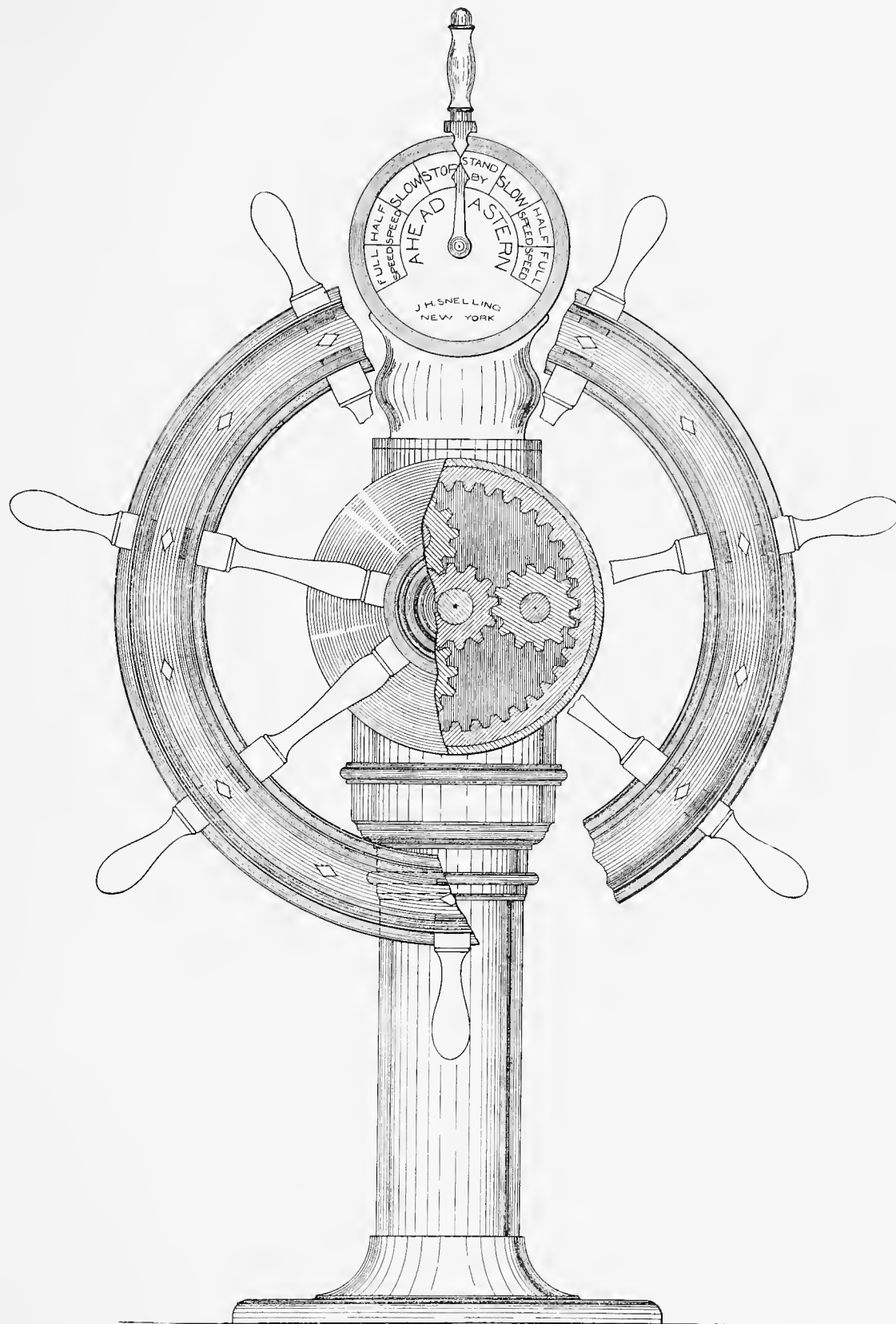

SNELLING'S COMBINED HAND STEERER AND ENGINE-ROOM TELEGRAPH.

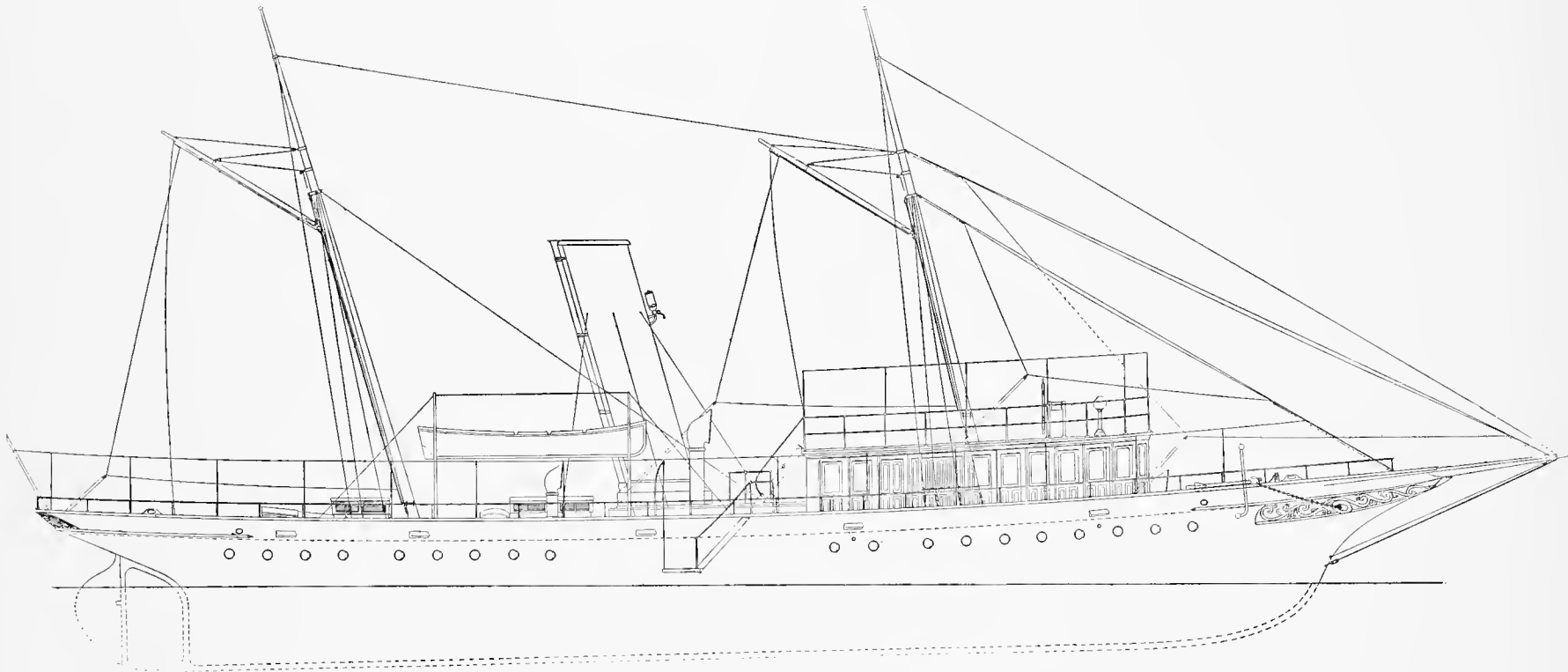

MRS. LUCY C. CARNEGIE'S STEAM YACHT DUNGENESS.—Built by the Maryland Steel Co., Sparrow's Point, Md.

the dial and operating lever of the telegraph, the supporting column carrying in its interior the necessary connections to the rudder, as well as the connections to a dial in the engine-room, which latter exhibits on its face a duplicate of the order transmitted from the bridge. The captain, therefore, while steering, has at hand the means of giving mechanically his orders to the engineer, and has before him the dial reporting visibly to him the correct reception of these orders from the engine-room. The machine is entirely of polished brass.

The Steam Yacht Dungeness.

This yacht was designed by Geo. B. Mallory, New York, and was constructed under his supervision at the works of the Maryland Steel Co., Sparrows Point, Md. Mrs. Lucy C. Carnegie, of Pittsburg, Pa., for whom she was built, is the owner of the magnificent estate on Cumberland Island, off the Georgia Coast, from which the yacht takes its name. The hull is of steel throughout, the dimensions being: Length over rail, 120 feet; load water line, 104 feet; beam, extreme, 20 feet; least freeboard, 4 feet; sheer, stem, 5 feet; transom, 1 foot; draught, stem, 5 feet; sternpost, 7 feet 6 inches. The deck house and fittings are of mahogany; the house is 31 feet long and from 12 feet to 8 feet wide, with a saloon 22 feet long, the after portion containing the captain's room, lavatory, etc. The owner's and guests' quarters are all forward. The heating apparatus consists of radiators under the cabin floors, taking

fresh cold air from the top of the house and heating it before it enters the cabins. The electric installation is very complete, including, besides a full outfit of lamps, special heating apparatus for plates, coffee urns, etc. The engines are compound, 13, 24 by 18, with a 6-foot wheel. The main boiler is 10 feet 6 inches in diameter and 10 feet long. The yacht was launched on March 10, 1894. The trial trip was made on April 28, the speed being 12 miles per hour for a run of 30 miles.

The Wooden Steam Yacht Clermont.

One of the handsomest steam yachts in this port is the Clermont, owned by A. Van Santvoord, of this city, and built to his order by the W & A. Fletcher Co., Hoboken, N. J., in 1892. The Clermont has a wooden hull, copper sheathed, built by H. Lawrence, Greenpoint, L. I.; length on load line, 150 feet 6 inches; over all, 160 feet 3 inches; beam, moulded, 25 feet; over planking, which is 2-inch oak, 25 feet 6 inches; over guards, 43 feet; depth of hold, amidships, 10 feet 8 inches; draught, ready for service, steam on, 5 feet 3 inches. The frames are of chestnut and oak, and are 10 inches deep at centers, with 25-inch centers. The machinery was built by the North River Iron Works, Hoboken, N. J., and comprises a beam engine with one 40-inch cylinder by 6 feet stroke, surface condensing, driving feathering wheels 17 feet diameter outside of buckets, by 6 feet 6 inches face; the buckets are of steel and curved.

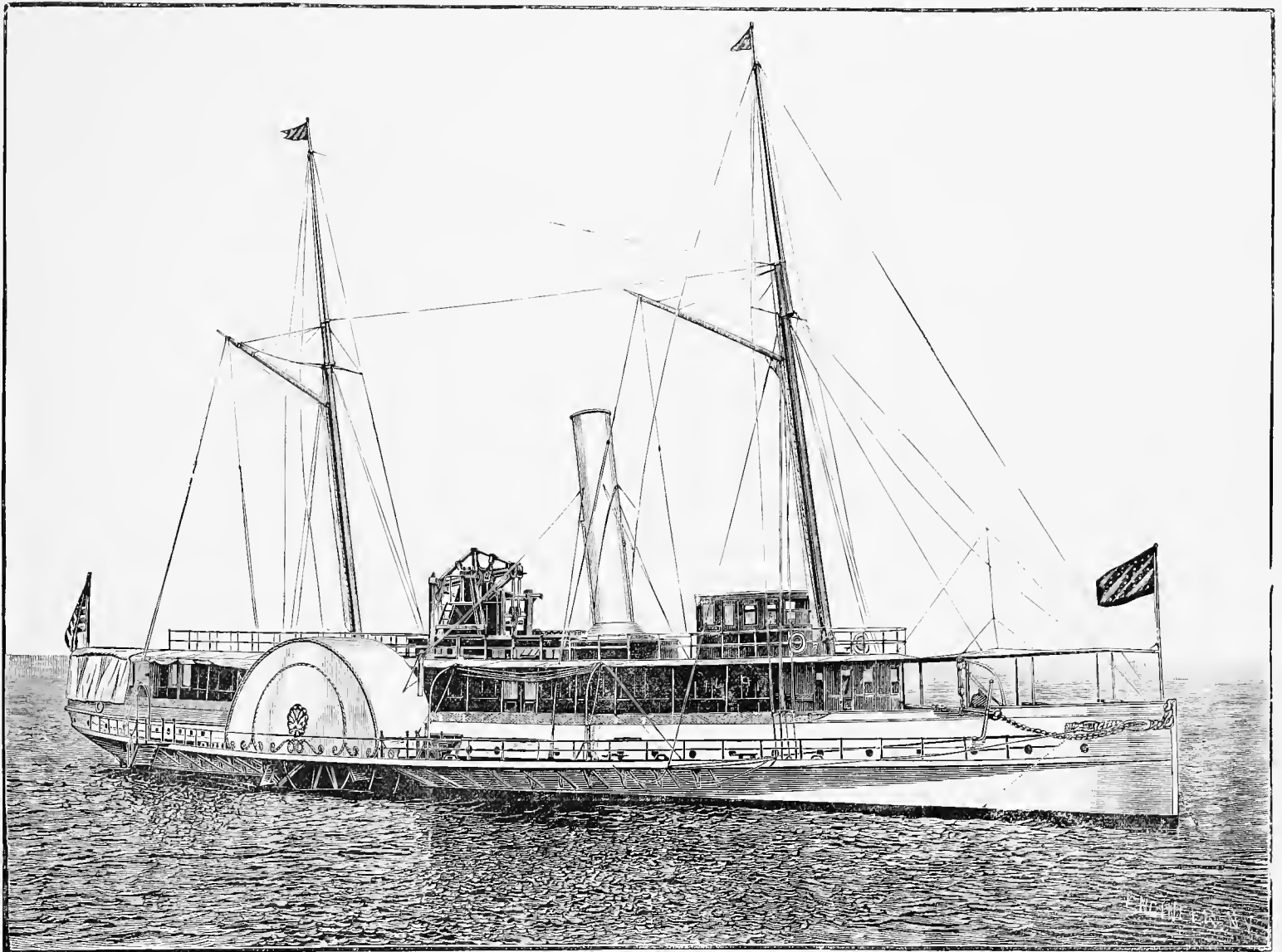

A. VAN SANTVOORD'S WOODEN STEAM YACHT CLERMONT.—Machinery by the W. & A. Fletcher Co., Hoboken, N. J.

There is one steel return flue boiler, built for 60 pounds working pressure; the shell is 8 feet 1 inch diameter, by 9 feet 6 inches wide on front, and a total length of 26 feet. The steam chimney is 3 feet 6 inches diameter inside, 6 feet 6 inches outside diameter, and 7 feet 8 inches high. Forced draught is provided, to be used if needed. A donkey boiler, to carry 125 pounds per square inch, is also furnished. The actual speed of the Clermont in dead water is 18 miles per hour, with 800 indicated horse-power, and 46 revolutions per minute of the wheels. The yacht was built for cruising, not for spurning, but she manages to maintain a high velocity notwithstanding. The joiner work is by John E. Hoffmire & Son, New York; the deck houses are 12 feet wide, mahogany outside, quartered oak and sycamore inside; the rooms on the main deck com-

prise a smoking-room, 12 by 14 feet forward; captain's and officers' mess-rooms forward; engine and donkey boiler-rooms amidships; two wash-rooms and water-closets, entrance to galley, stairs and extra refrigerator, all amidships outside engine frame. Also, on main deck, entrance to lower saloon, butler's pantry, dining-room, all aft; owner's room (very large), private bathroom, hot and cold water, and water-closet connecting with it, extreme aft, deck house. The smoking-room, forward, is so fitted and arranged that it can be converted into a sleeping-room, having wash basins, etc., concealed. The rooms below comprise mates, engineers, firemen and sailors' quarters forward, galley and steward's apartments amidships, and dumb waiter from galley to butler's pantry on main deck; there are three large staterooms for guests aft; a bathroom,

hot and cold water, and water-closet aft; a cloak and baggage storeroom aft; a very large music room, elegantly furnished with silk tapestry on the walls and plush cushions, oil paintings, piano, writing desk, bookcase, etc. Rooms below deck: Miss Van Santvoord's room—the owner's daughter—is in the extreme aft; it is elegantly decorated, has private wash-room and every convenience attached. The advantages of a sidewheel yacht are, speed on light draught and quiet running, there being no vibration whatever on the Clermont, and, lastly, great comfort and room to move around in.

The Steam Yacht Restless.

The present owner of this iron craft is Hiram W. Sibley, of Rochester, N. Y., who fitted her with new machinery in the spring of 1895. The Restless was built by Houston & Woodbridge, Linwood (or Marcus Hook), Pa., in 1887. Length over all, 131 feet, load water line, 113 feet; beam, 16 feet; draught, 7.6 feet. She has a Roberts water-tube boiler, 9 by 9 feet, put in with all improvements in March, 1894, which carries 200 pounds of steam, working pressure. Her engine

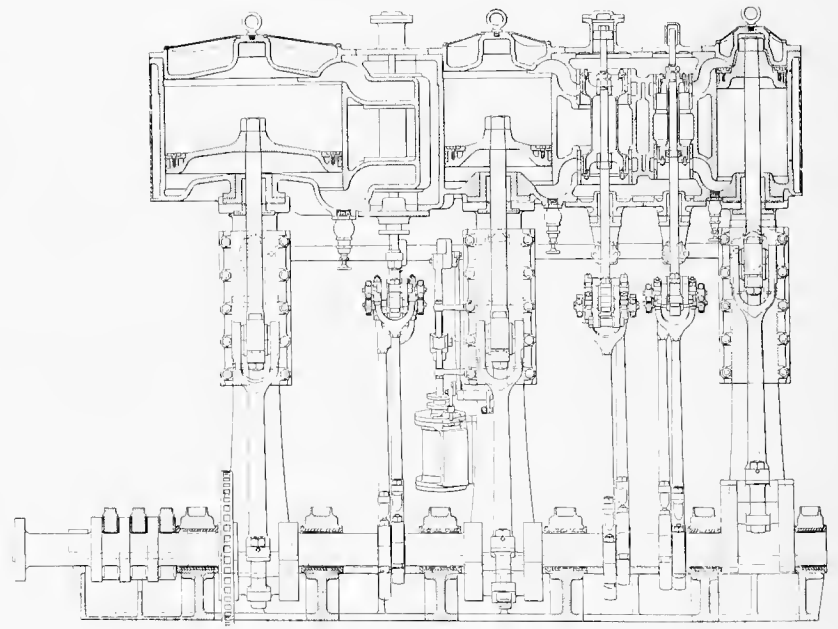
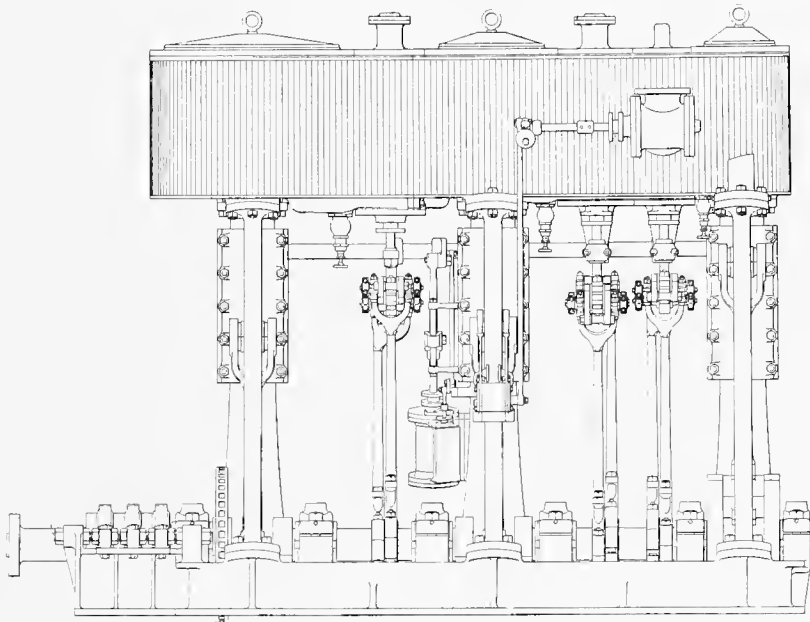
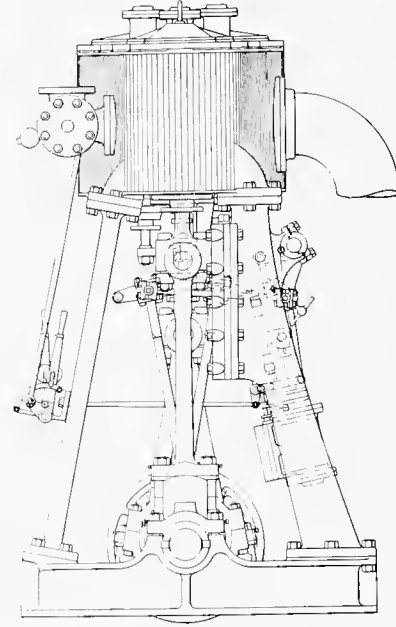

TRIPLE-EXPANSION ENGINE OF H. W. SIBLEY'S STEAM YACHT RESTLESS.—Built by F. W. Wheeler & Co., West Bay City, Mich.

was built by F. W. Wheeler & Co., West Bay City, Mich., and is of the triple-expansion type, 12, 18 and 30 by 16 inches, driving a Trout propeller wheel, 5 feet 6 inches diameter and 9 feet pitch. The cylinders are placed in the order of high, intermediate and low, with high-pressure and intermediate valves between their respective cylinders, and both low-pressure valves between the intermediate and low cylinders. Owing to the limited space, the high-pressure and intermediate cylinders were cast together, and the intermediate and low-pressure were connected by a steam belt around the former cylinder. The ports in the high-pressure cylinder are $1\frac{3}{4}$ by 9 inches, in the intermediate cylinder $2\frac{1}{4}$ by 15 inches, and $3\frac{1}{4}$ by 26

inches in the low. The main steam pipe is 5 inches diameter, and the exhaust pipe to the condenser is 11 inches diameter, both pipes being of copper. The throttle valve is of the balanced cylindrical type and fitted with a relief valve. Steam is admitted in the middle of the high-pressure valve to the high-pressure cylinder, exhausts at both ends directly to the intermediate valve, from the middle of which it exhausts into a belt around the intermediate cylinder directly to both ends of the low-pressure valve, and exhausts from the inside of the valves to the condenser. The cylinders are fitted with piston valves throughout, of the following diameters: High-pressure, $5\frac{1}{2}$ inches; intermediate, 8 inches, and two 8 inches on the low-

pressure. The high-pressure valve is fitted with loose rings so as to be easily removed when worn, and has 1 1-16 inches lap on top and 31-32 inch lap on bottom, with 1-16 inch exhaust lap on bottom. The intermediate valve is fitted with self-setting spring rings, and has 1 1/8 inches lap on top and 1 1-32 inches lap on bottom, with 1/8 inch exhaust lap on bottom. The low-pressure valves are also fitted with self-setting spring rings, and have 1 3-16 inches lap on top, 1 3-32 inches lap on bottom, and 1/8 inch exhaust lap on bottom. All valves have 4 inches travel, and are worked directly by the Stephenson double bar link motion with adjustable cut-off arrangement.

all of steel. The cylinders are supported by three cast-iron columns with guides for the slippers, and three wrought-iron columns in front. The bedplate is of the girder type with the thrust bearing cast on, and has six main journals. The crank shaft is solid, forged of mild steel 5 1/2 inches diameter, and the crank pins are 5 1/2 inches diameter by 7 inches long. The cranks are placed 120 degrees apart in the sequence of intermediate, high-pressure and low-pressure, and are 2 3/4 inches thick on high-pressure, 3 inches on intermediate and 3 1/4 on low-pressure, all being 7 1/2 inches wide. The three thrust collars are forged on the crank shaft and are 11 inches diame-

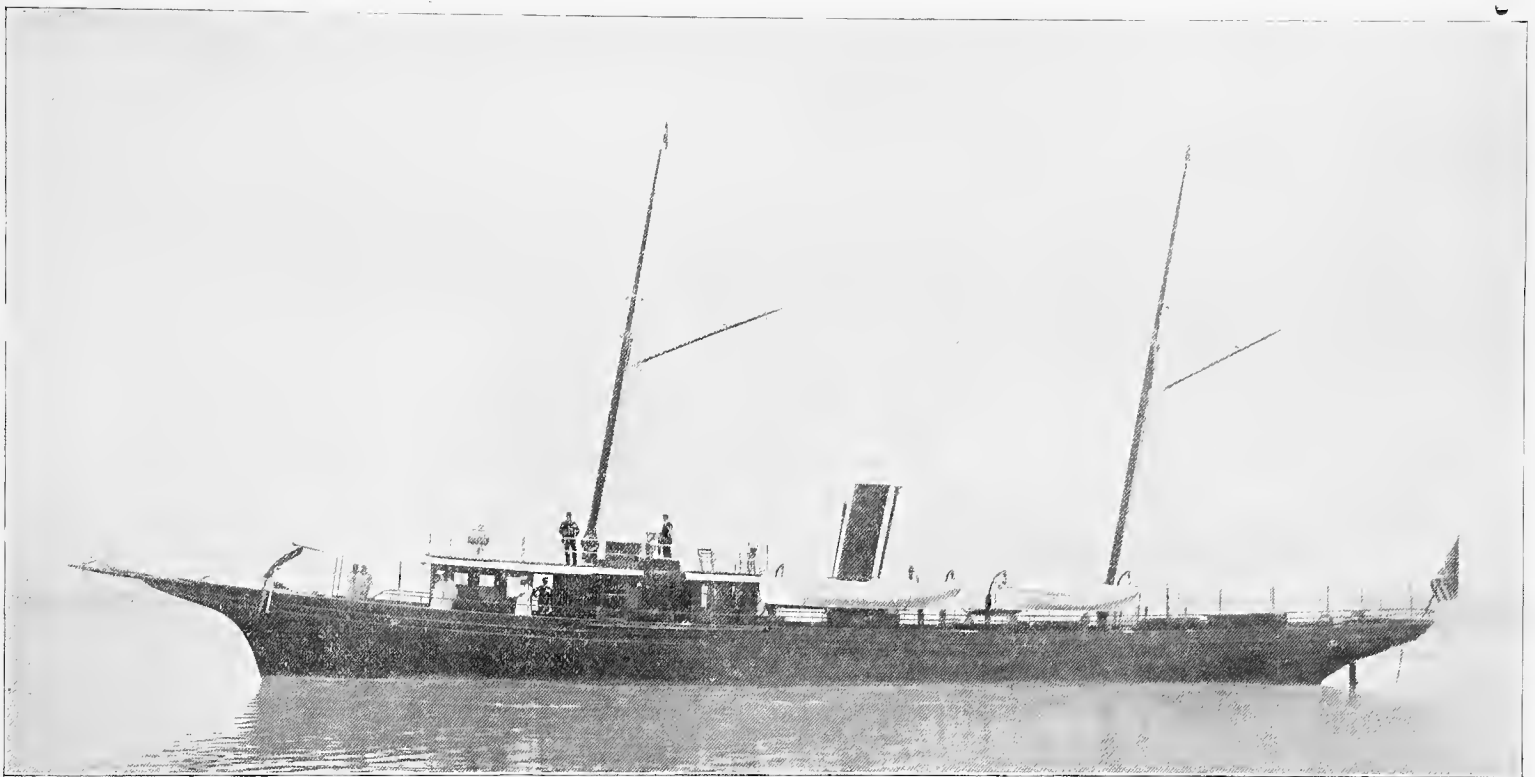

THE IRON STEAM YACHT RESTLESS.—Owned by Hiram W. Sibley, of Rochester, N. Y.

All valve stems are 1 1/2 inches diameter of machinery steel, and work in adjustable guides fitted with brass bushings. The low-pressure valve stems are connected together by a wrought-iron cross-arm, and one set of eccentrics and links work both valves. The eccentrics are cast iron two inches wide, with cast-iron straps. The engine is supplied with steam reversing gear, having a cylinder 5 inches diameter and 8 inches stroke, operated by differential valve motion under easy control of the engineer. All pistons are cast-iron discs, 3 1/2 inches deep at sides secured to piston-rods by quick taper and nuts. The piston-rods are 2 5/8 inches diameter of machinery steel forged solid with the crossheads. The slippers are provided with brass gibs 11 inches deep by 8 inches wide, and the gudgeon is 3 1/4 inches diameter by 5 inches long. The connecting-rods are also of steel, 40 inches between centers, 2 1/2 inches diameter at upper ends and 3 1/8 at lower, with upper end worked to suit crosshead. The bolts in crossheads are 1 3/8 inches diameter, and in connecting-rods are 1 1/2 inches diameter,

ter, and 1 3/4 inches thick. The horseshoe collars are faced with anti-friction metal, and are adjusted by means of steel bolts and brass nuts. All crank-pin brasses and main journals are lined with anti-friction metal. The cylinders are covered with magnesia and lagged with highly-polished mahogany. All reversing gear is placed on the back of the engine, thus giving an open front with free access to all journals and working parts. The surface condenser is independent of the engine and has 795 5/8 inches brass tubes, 19 S. W. G. 6 feet 6 inches long, giving a cooling surface of 847 square feet. The air and the circulating-pumps are of the Blake combined type with steam cylinder between; size, 8 by 9 by 9 by 10 inches. Throughout the whole engine everything is finely finished and compares favorably with the best class of high-speed yacht engines. On the trial trip in Saginaw Bay, the engine made 250 revolutions per minute with 200 pounds of steam, and everything worked nicely. The engine was built from designs made by S. Anderson, engineer with F. W. Wheeler & Co.

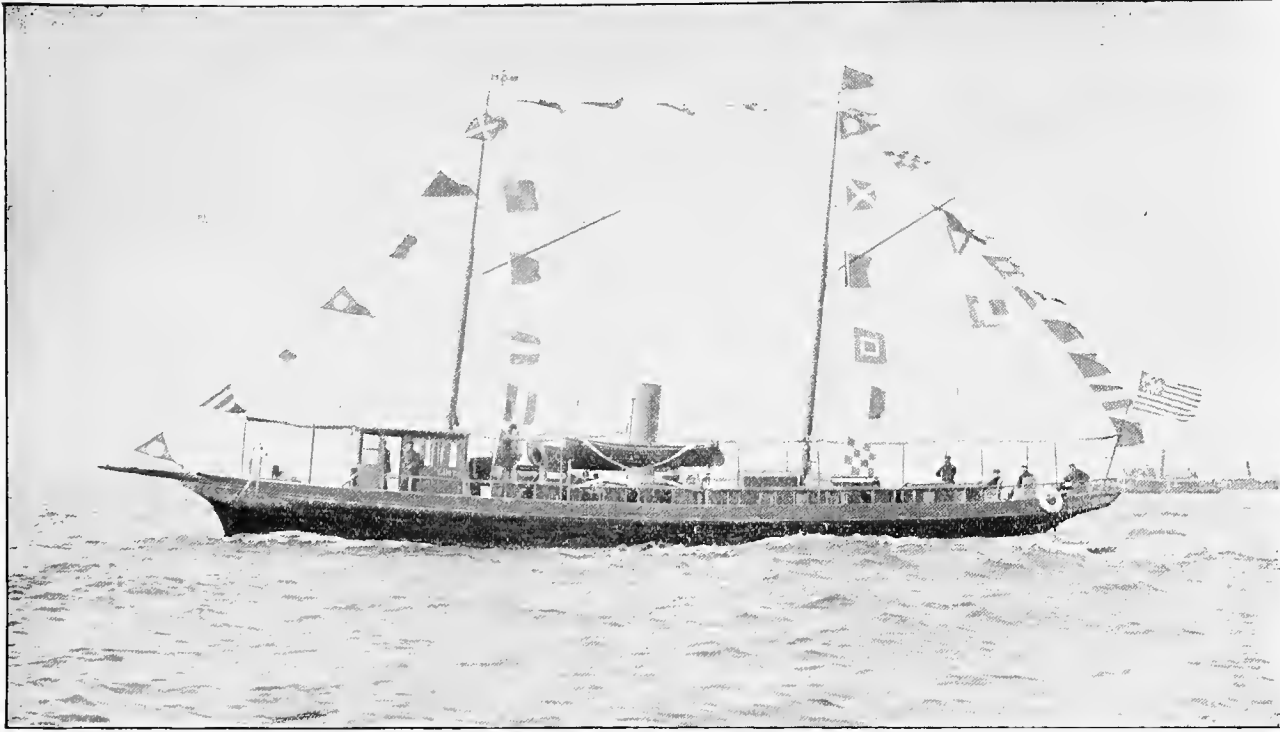

THE WOODEN STEAM YACHT LINTA.—Built by Chas. L. Seabury & Co., Nyack, N. Y.

Wooden Steam Yacht Linta.

The illustration of the steam yacht Linta, built by Chas. L. Seabury & Co., of Nyack-on-the-Hudson, for Walter Luttgen, of this city, was taken from a photograph obtained while the yacht was steaming past the Battery, during the Columbus Naval Parade, October 11, 1892. She was constructed that summer. Her dimensions are as follows: Length over all, 85 feet; load water line, 72 feet; beam, 14 feet, draught, 5 feet. She was designed as a small family cruiser, with an average speed of 12 miles an hour.

The Wooden Steam Yacht Calypso.

Built by the Atlantic Works, of East Boston, in 1894, for Harry E. Converse, of Malden, Mass. The hull is of wood. The principal dimensions are: Length on load water line, 102 feet; beam, 17 feet; draught, 7 feet 4 inches, with tanks and bunkers full and all stores on board. Her engines are of the fore-and-aft vertical inverted direct acting compound type, with cranks set at 90 degrees. The cylinders are 12 and 22 inches diameter, and the stroke of piston is 16 inches. The main valves are of the piston type, and are actuated by a Stephenson link motion. She has a cylindrical surface condenser with 400 square feet of cooling surface. There are two independent feed-pumps, and a combined air and circulating-pump, all of the

Blake type. There is a Hancock locomotive inspirator and a bilge ejector. There is an auxiliary suction pipe and valve from the circulating-pump to the bilge for use in case of emergency. She has thus three different methods of feeding boiler and four different ways to discharge from the bilge. The boiler is of the Army double-tube type, the safety valve being set for a working pressure of 130 pounds.

The Steam Yacht Embla.

This craft was built in 1893 by Chas. L. Seabury & Co., Nyack, N. Y., for John H. Hanan, New York. The hull is composite built. Dimensions: Length over all, 163 feet; length, water line, 133 feet; beam, 20 feet; draught, 8 feet. The keel is of white oak, also the stern post, stem post and deadwoods, while frames or timbers are of steel. The reverse frames, keelsons and deck beams are steel, fastened and riveted to frames. There are five steel bulkheads so arranged as to make watertight compartments. The machinery is a triple-expansion engine, surface condensing, and two Seabury water-tube boilers of the bent-tube type, specially adapted for large vessels. Coal bunkers are arranged either side and end of boiler-room. They hold forty to fifty tons. The boiler water tanks have large capacity. Her speed is eighteen miles an hour. The builders were also the designers, but A. Cary Smith represented the owner in superintending and making inspection of the work as it progressed.

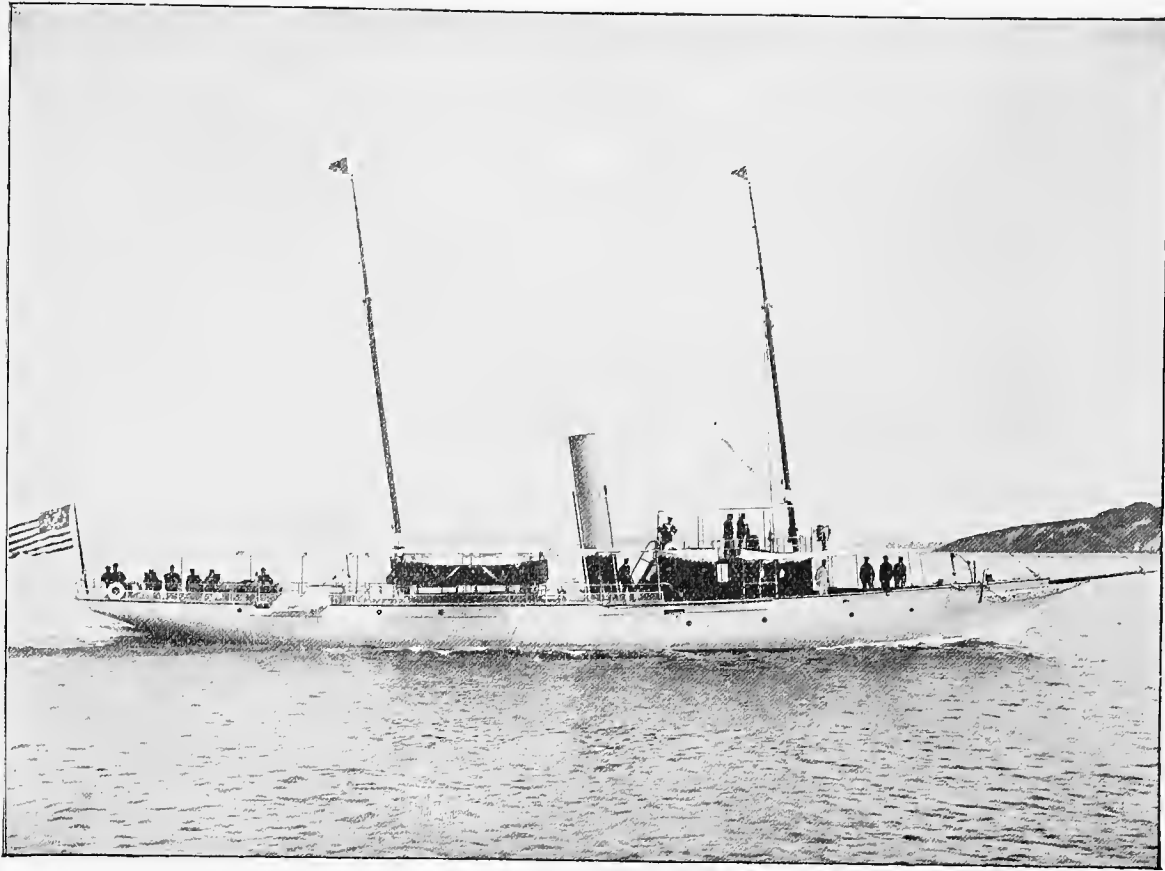

THE WOODEN STEAM YACHT CALYPSO.—Built by the Atlantic Works, East Boston, Mass.

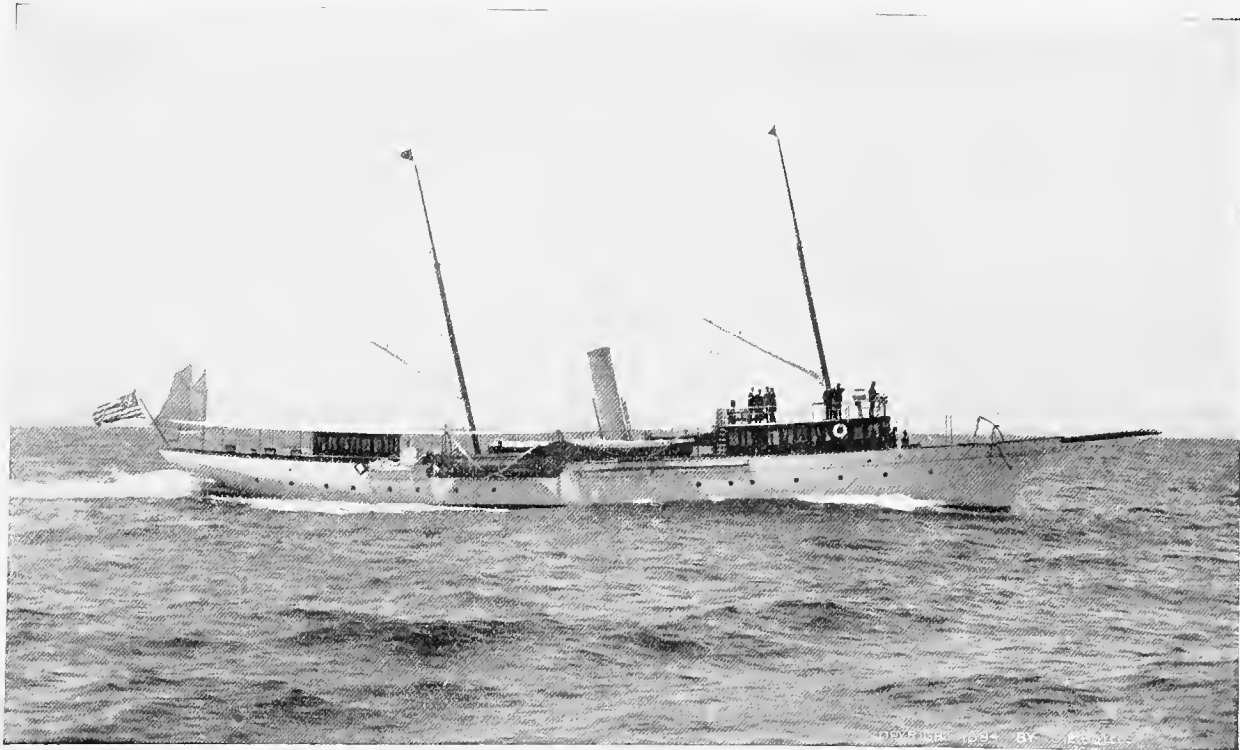

JOHN H. HANAN'S STEAM YACHT EMBLA.—Built by Chas. L. Seabury & Co., Nyack, N. Y.



AUXILIARY STEAM YACHT WILD DUCK.—Built at the Atlantic Works, East Boston, Mass.

Auxiliary Steam Yacht Wild Duck.

The designs for the steam yacht shown in the illustration were made by the late Ed. Burgess. The view represents the yacht under sail alone, and she has been proved to work well to windward, tacking within ten points. She was built in 1892 for Hon. John M. Forbes, at the Atlantic Works, East Boston. Her length on the water line is 125 feet, and from the outside of stem to outside of rail, aft, 154 feet 6 inches; beam, moulded, 23 feet 6 inches; depth from upper side of deck beam to top of keel, 12 feet 6 inches; draught, 7 feet 6 inches. The general specification for engine, boiler and screw were made by Miers Coryell, of New York. The hull is built of mild steel to Lloyd's rules. The power consists of two Belleville boilers

furnished with separate and automatic pump. The engines were designed by Jas. T. Boyd, and are of the triple-expansion type, 10 inches high-pressure, $14\frac{1}{4}$ inches intermediate-pressure, $28\frac{1}{2}$ inches low-pressure, with 18 inches stroke of piston. The condenser forms part of the framing of the engine and contains 600 square feet of cooling surface. Air and circulating-pumps 8 inches steam, 10 inches air and 10 inches water. The propeller wheel is of the Bevis patent. The vessel is fitted with a steel centerboard 21 feet long, 6 feet $7\frac{1}{4}$ inches wide, hung with the Burgess hook. The smokestack is telescopic, which, together with the centerboard, are worked from the top of the house. In her trial trip, under steam only, she made a speed of 10 3-10 knots without any forcing. Revolutions of engine, 208 per minute. Steam pressure at engine, 180 pounds per square inch.

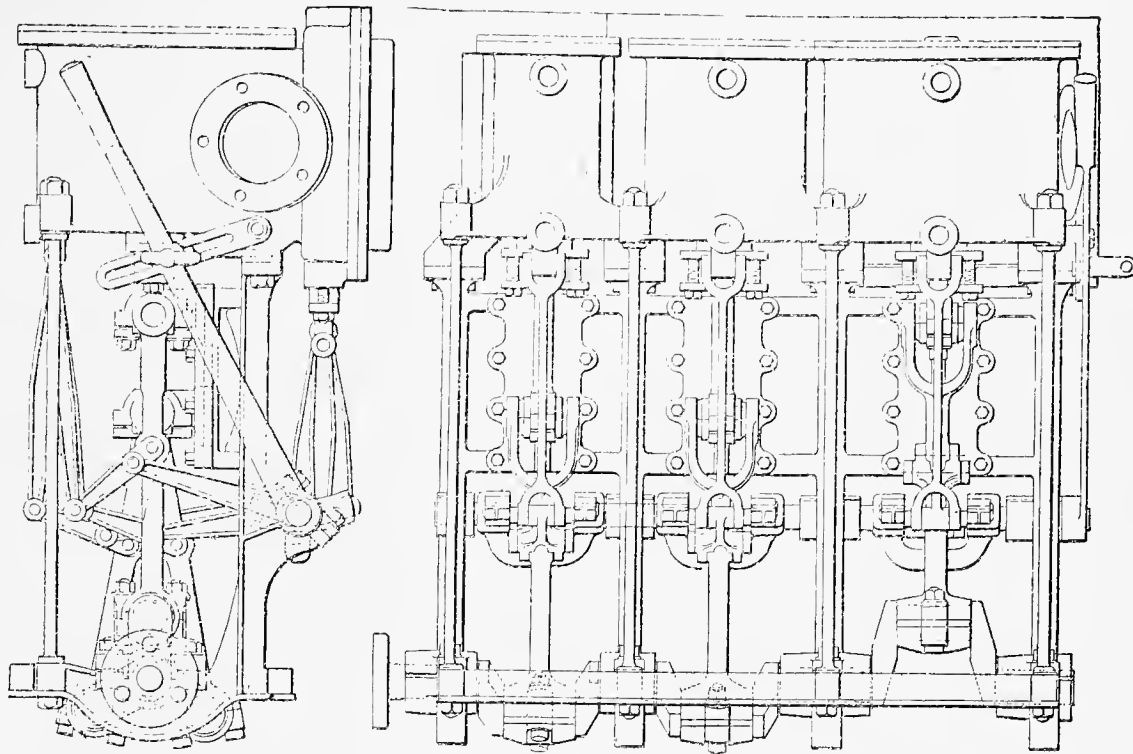

TRIPLE-EXPANSION ENGINE OF 36-FOOT STEAM LAUNCH WILD DUCK.

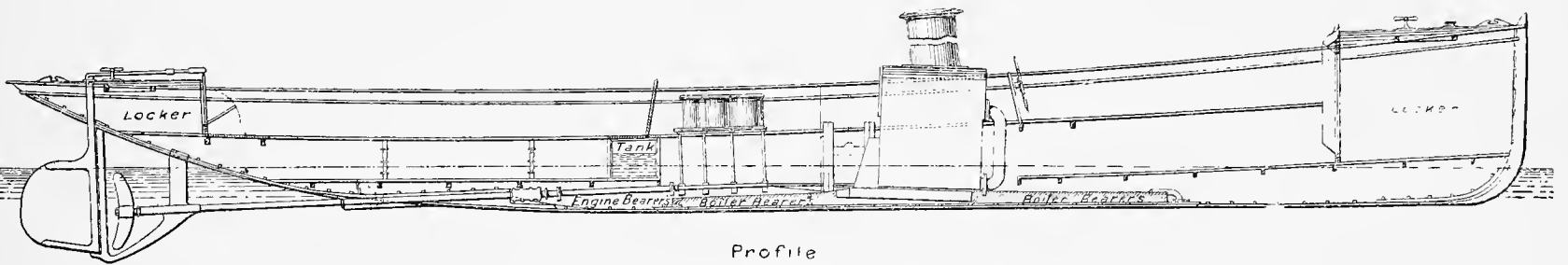

Profile

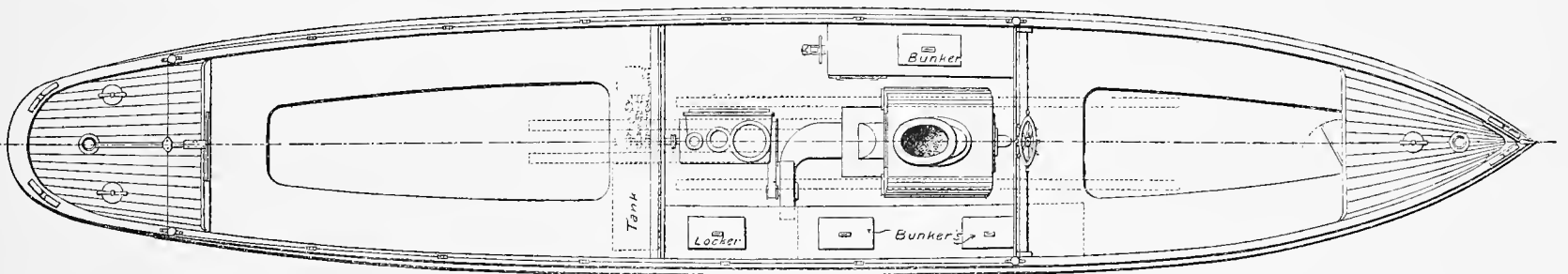

Plan

THE FAST BRITISH STEAM LAUNCH WILD DUCK.—Built by Simpson, Strickland & Co., Dartmouth, South Devon, England.



THE WOODEN CLIPPER SHIP MORNING LIGHT.—Built by Wm. Cramp, of Philadelphia, in 1853.

The Fast British Steam Launch Wild Duck.

The steam launch Wild Duck was built by Simpson, Strickland & Co., Dartmouth, South Devon, England. The boat is 36 feet long by 6 feet beam, has engines with cylinders $3\frac{3}{4}$, 6 and 9 inches by 5 inches stroke, and a water-tube boiler of the firm's patent marine type. Her machinery space is only 10 feet of her length. On her trial trip she made 16 miles an hour. The working pressure is 180 pounds, and the engine runs at about 750 revolutions. The engine is too small to indicate satisfactorily at this speed, but from the pressure in the cylinders and the revolutions, the builders estimate the indicated horse-power at about 50. The engine is illustrated by a front elevation and end elevation at the low-pressure cylinder end. They are of the usual design of the firm, with cast-steel bed frame and back standards, and turned steel vertical columns in front. The Wild Duck is intended for sea service.

Clipper Ship Morning Light.

The immediate precursor of the modern "ocean greyhound," was the clipper ship of the forties and fifties. In the

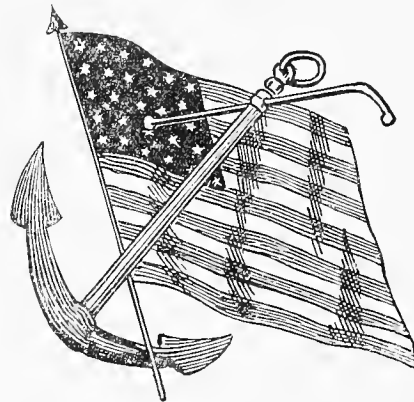

infancy of steam navigation, the stately clippers, with their splendid hulls, great spars and enormous spread of canvas often outstripped the steamers. One of the most celebrated and successful clippers of her day was the Morning Light, built by William Cramp, in 1853, for the account of Buckner & McCammon, of Philadelphia. The "poetry of the sea" became idyllic in these winged ships, which rode the waves more like living creatures than like mechanical structures. The Morning Light has been preserved by the cunning hand of the artist, that the generations who see only transatlantic liners in commerce, and huge floating castles bristling with turrets and casements and clad with thick steel for war, may know in what kind of ships their forefathers went down to the sea. The Morning Light was one of the smallest of the

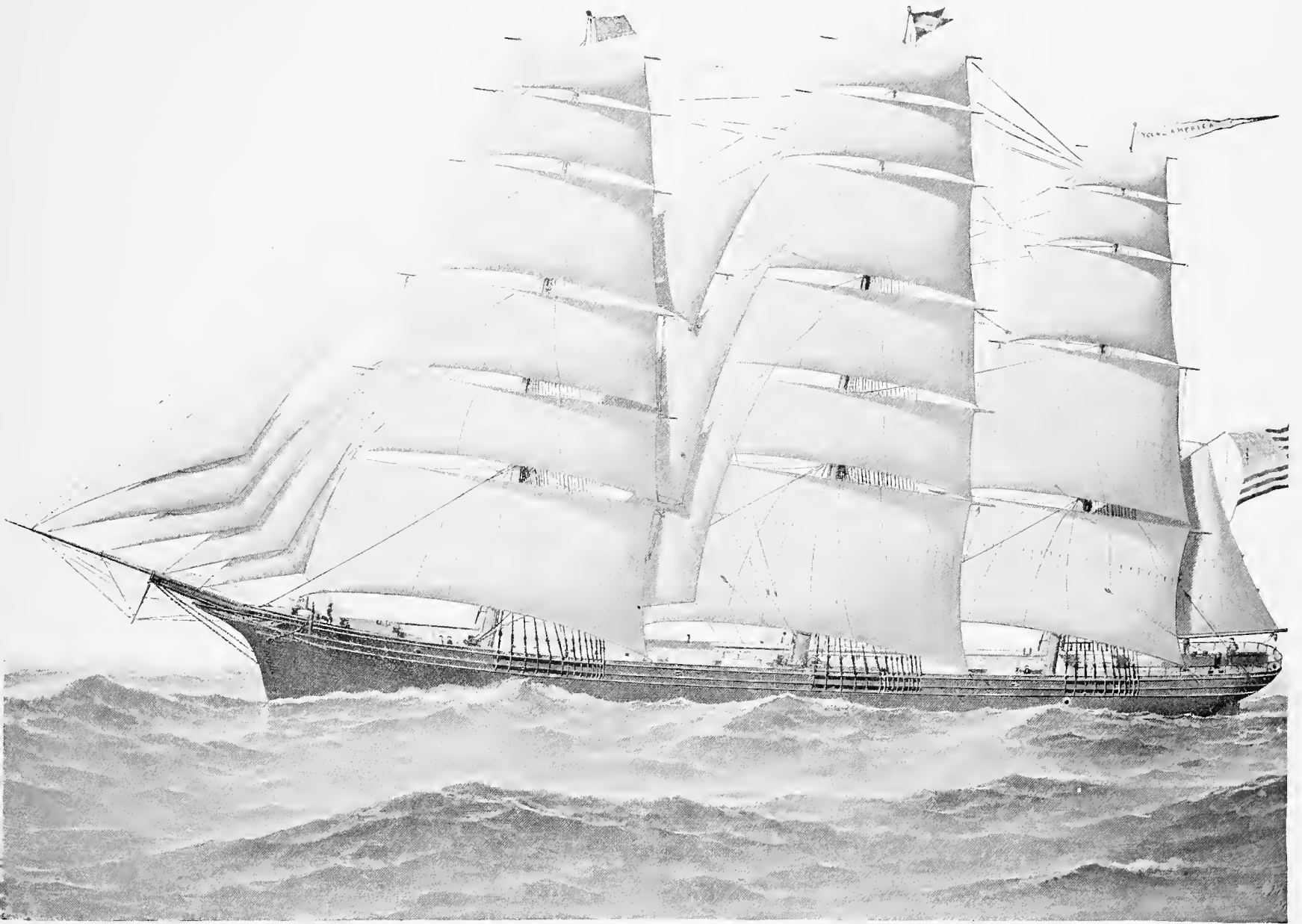

THE CELEBRATED CLIPPER SHIP YOUNG AMERICA.—Built in 1853, by Wm. H. Webb, for George Daniels, of New York.

clipper ships built by Wm. Cramp during that period, but none of the others has been preserved by art. The Bridgewater was nearly twice the tonnage of the Morning Light, as was also the Manitou. They were all of the same type, and the shipbuilding records of that time agree that the full-rigged clipper ships of the Delaware represented the perfection of naval architecture, and for many years spread the fame of the American shipyards to every quarter of the globe. Larger sailing ships have since been built both in wood and iron, but so far as model, seaworthiness and symmetry are concerned, they have not been improved upon. The supremacy of Philadelphia in the shipbuilding art was established before the beginning of the

century, and the sailing record between Cape Henlopen and Liverpool is still held by a Philadelphia ship, the Rebecca Sims, built in 1800, of which further mention will be made. Thus the competitors whom William Cramp had to meet with at the outset of his career, were masters of the art, and to hold way with them he had to build ships rating with the best in the world. The Morning Light was principally employed in the California trade around Cape Horn, in which she made a number of remarkably successful voyages. Though, as already remarked, much smaller than other Cramp-built clippers, she was considered one of the best sea boats, and fastest and most weatherly sailers of her time.

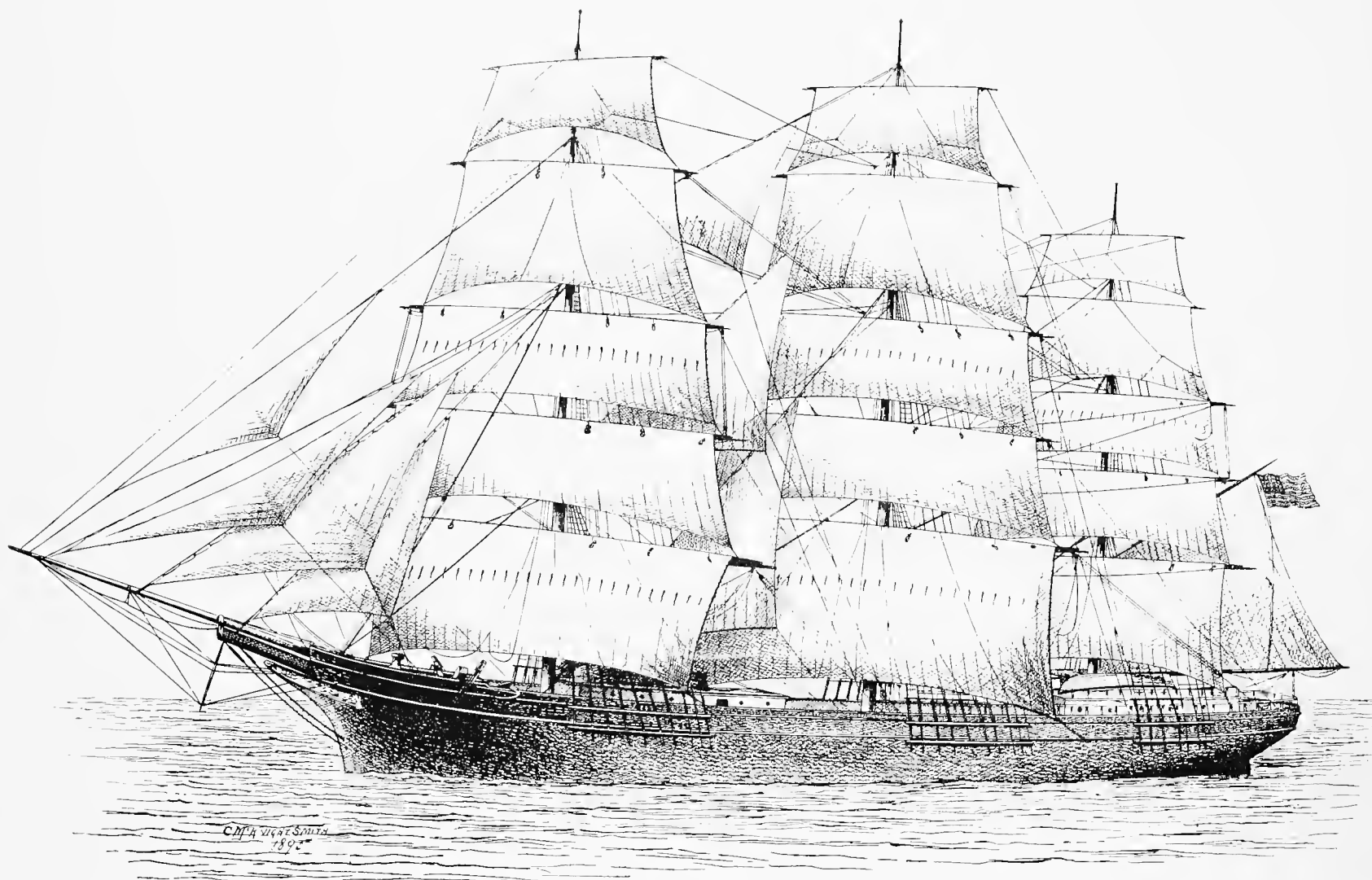

ARYAN, THE LAST WOODEN SAILING SHIP BUILT IN THE UNITED STATES.—Constructed by Charles V. Minot, Phippsburg, Maine.

The Celebrated Clipper Ship *Young America*.

This country became renowned for its extraordinarily fast wooden clipper ships during the years between 1845 and 1865, before steamships had taken the wind out of sails, and the fastest of all these Yankee clippers was the world-renowned *Young America*, built in New York by America's greatest wooden shipbuilder, Wm. Henry Webb, for George Daniels, and associates, of New York. The builder of this ship is the founder of Webb's Academy and Home for Shipbuilders, at Fordham Heights, N. Y. He is spoken of as the "Grand Old Man" of American shipbuilding. One of the features of this ship that every sailor will readily notice, is that she has only a single mizzen topsail, containing three reefs, while the fore and main topsails are double. Capt. E. C. Baker, ex-Superintendent of the United States & Brazil Steamship Company, commanded

the *Young America* when she made some of her fastest passages. Capt. Baker was very proud of his ship and often spoke of her wonderful sailing qualities. Other friends and admirers of this splendid clipper were Jabez Howes and John Rosenfeld, both of San Francisco, to whom she once belonged. About the year 1888, the *Young America* was sold to an Austrian firm who changed her name to the *Miroslav*. Shortly afterward the ship left Philadelphia with a cargo of oil, bound for Fiume, France, and was never afterward heard from. Thus ended the career of the fastest wooden ship in the world. A full-rigged model of this craft is in the possession of J. D. Spreckels & Bro., of San Francisco, who prize it above money. Dimensions: Length on deck, 235 feet; beam, moulded, 40 feet 2 inches; depth of hold, 25 feet 9 inches; tonnage, o. m., 2300 tons, n. m., 1,439 tons. Built expressly for the California and East India trade in 1853. Her mainmast was 207 feet in

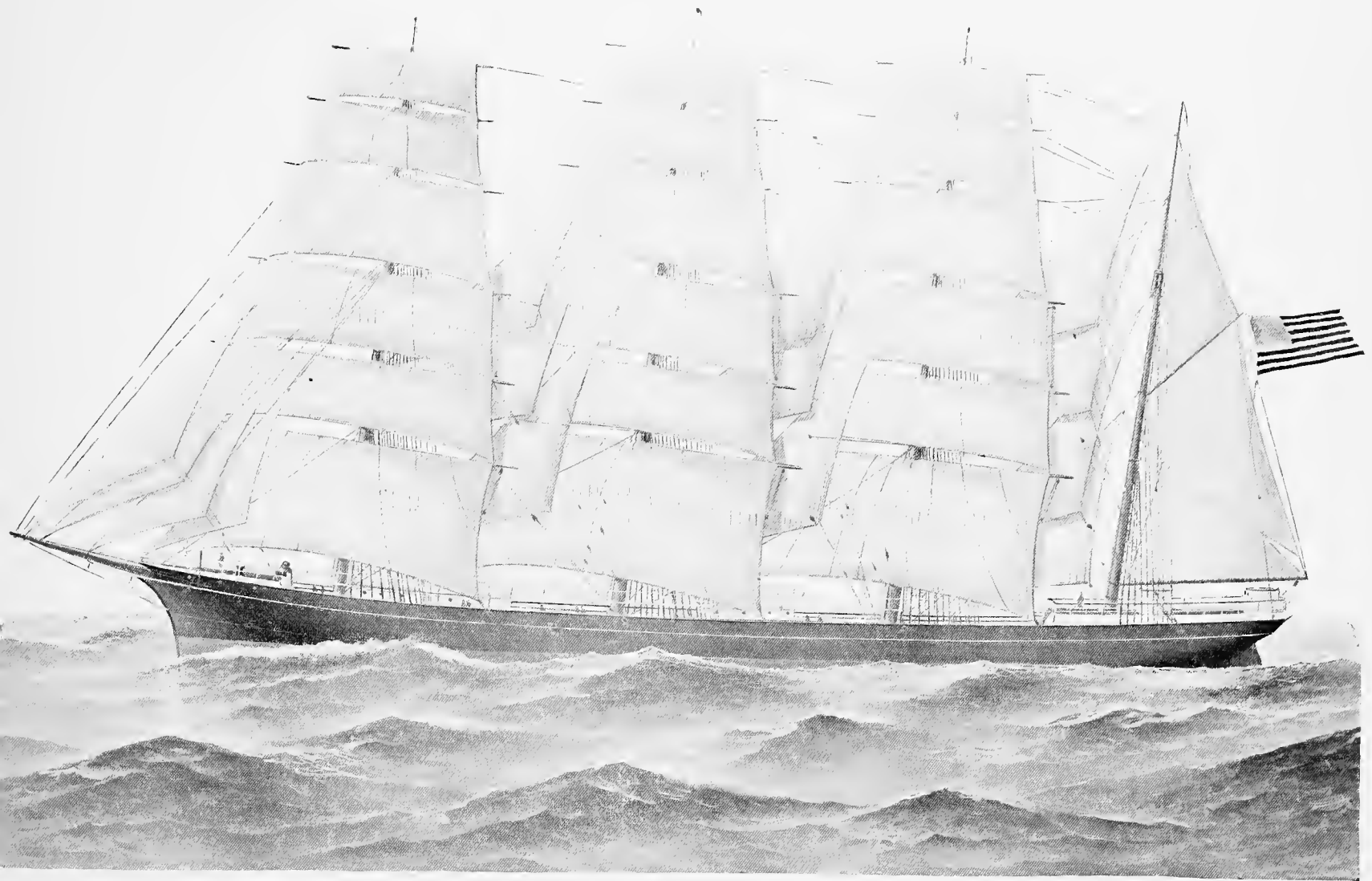

THE STEEL SHIPENTINE DIRIGO.—The First Four-Masted Iron Ship built in America. Constructed and Owned by Arthur Sewall & Co., Bath, Maine.

length. She sailed on a voyage from New York to San Francisco, from 50 degrees of latitude in the Atlantic Ocean to 50 degrees of latitude in the Pacific Ocean, in six consecutive days. She made a trip from 'Frisco to New York in 83 days, the fastest on record; New York to Liverpool, 18 days; Liverpool to Melbourne, 81 days. Callao to Queenstown, 74 days. Glasgow to Otago, New Zealand, 88 days. Otago to Callao, 36 days. San Francisco to Hong Kong, 47 days. Manilla to New York, 98 days. She beat the American ships Invincible and David Crockett and the British clipper Thermopylae on several occasions. The Young America once made 15 knots an hour for 80 hours while under command of Capt. Horace T. Bader, of West Yarmouth, Mass. One of her commanders was the late Capt. David S. Babcock, who was afterward President of the Providence and Stonington Line,

and the father of W. I. Babcock, General Manager of the Chicago (Illinois) Shipbuilding Company. George Howes, of New York, says he never saw a more beautiful ship than the Young America. She had a counter like a pilot boat. A good drawing of the Young America will be found in Webbs' Work on Shipbuilding, by Wm. H. Webb.

The Wooden Ship Aryan.

The illustration represents the last wooden ship built in the United States. The Aryan (meaning the last of her race) was launched on July 13, 1893, from the yard of Charles V. Minott, Phippsburg, Maine, and is owned by her builder, Jas. W. Elwell & Co., New York, and Capt. W. R. Dickinson (late

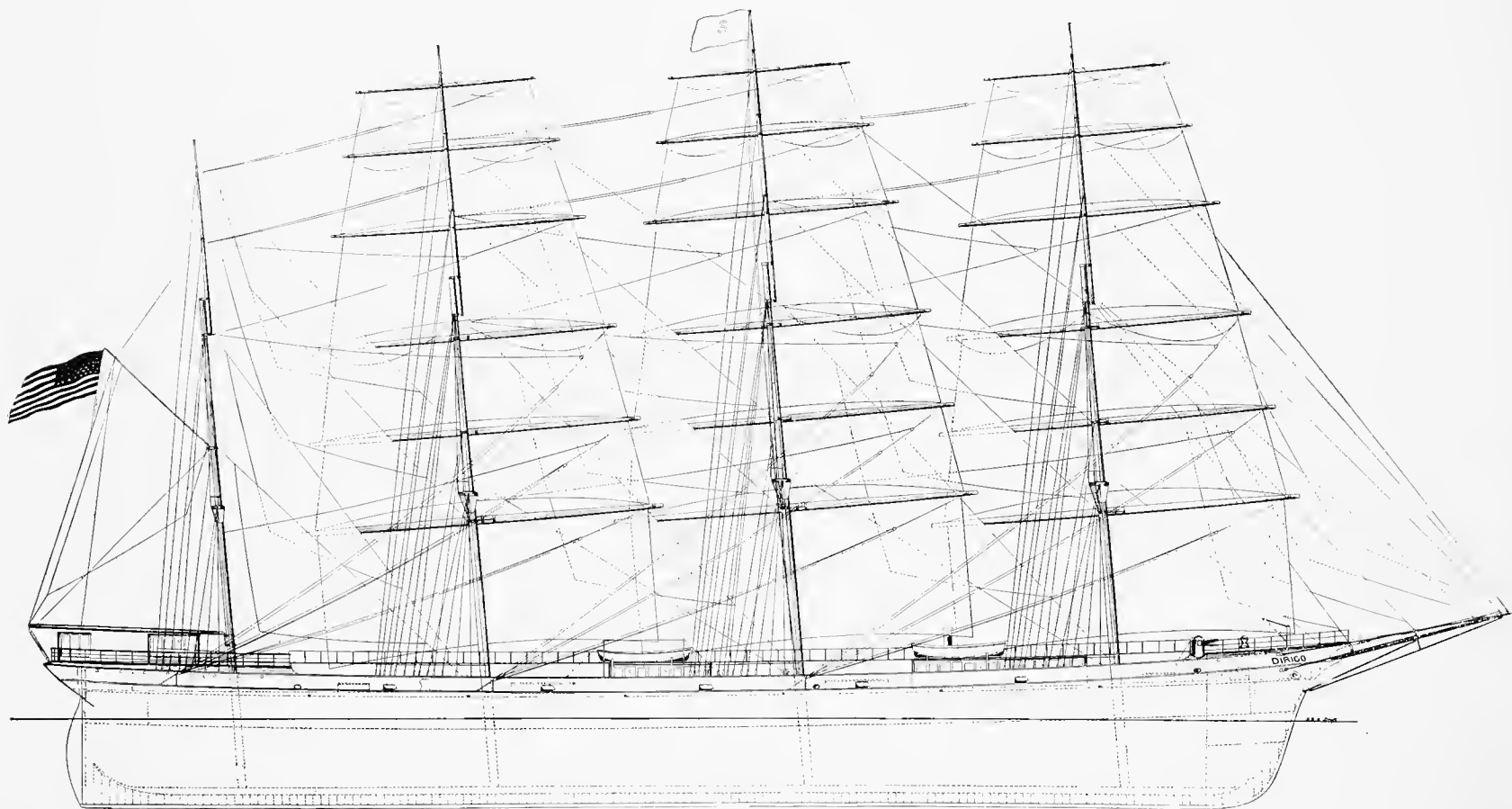

DIRIGO, THE FIRST AMERICAN STEEL SAILING SHIP.—Built by Arthur Sewall & Co., Bath, Me.

of the shipentine Rappahannock), who commands her. The dimensions of the vessel are as follows: Length, 248 feet 6 inches; beam, 42 feet 2 inches; depth, 26 feet 3 inches; net tonnage, 2,017; gross tonnage, 2,123. She cost about \$45 per ton, ready for sea. Her crew number 25 men. The Aryan can carry 3,400 tons of wheat. One of the great influences that has brought about the decadence of the American sailing ship is the change from wood to iron in their construction. Another important factor in driving American ships off the sea has been the change from sail to steam, and, lastly, the advent of the low priced, cheaply manned and cheaply run British tramp steamer. The new tramp steamers, with triple and quadruple-expansion engines, will carry 4,000 tons of cargo on a consumption of only 15 to 20 tons of coal per day, making a speed of from 9 to 10 knots an hour. Their crew consists of only from 8 to 10 men before the mast, about the same number of stokers, and in some cases only two engineers. A sailing ship of 4,000 tons capacity would require from 25 to 30 sailors. Another era in cheap ocean transportation is dawning—we refer to the turret deck or whaleback type of steamers with quadruple-expansion engines and water-tube boilers. A fleet of turrets have already been built. These vessels are cheap to build, cheap to run and easily kept in

working order. They represent the very acme of economy in the construction and running of cargo steamers. This, then, is one of the greatest factors in forcing our American sailing ships off the face of the waters. The building of the Nicaragua Canal will complete the work of final extinction.

The First American Steel Sailing Ship.

Dirigo (meaning in Spanish "I direct") was designed and built by Arthur Sewall & Co., of Bath, Maine, who own her. The general dimensions are: Length, 312 feet; breadth, 45 15-100 feet; depth 25 6-10 feet; gross tonnage, 3,004.80; net tonnage, 2,855.79. These figures are Custom House or official measurements. The name of the vessel is the motto of the State of Maine. She was launched February 10, 1894. She spreads about 12,500 yards of canvas. Her three skysail yards give her a clipper-like appearance.

The ship is designed to carry a full cargo on 22.6 feet draught, and to stand up without ballast when light in port. She has a flush main deck of steel fore-and-aft, the whole of which is sheathed with $3\frac{3}{4}$ -inch hard pine planking. The lower deck has steel stringers and tie plates, and is planked

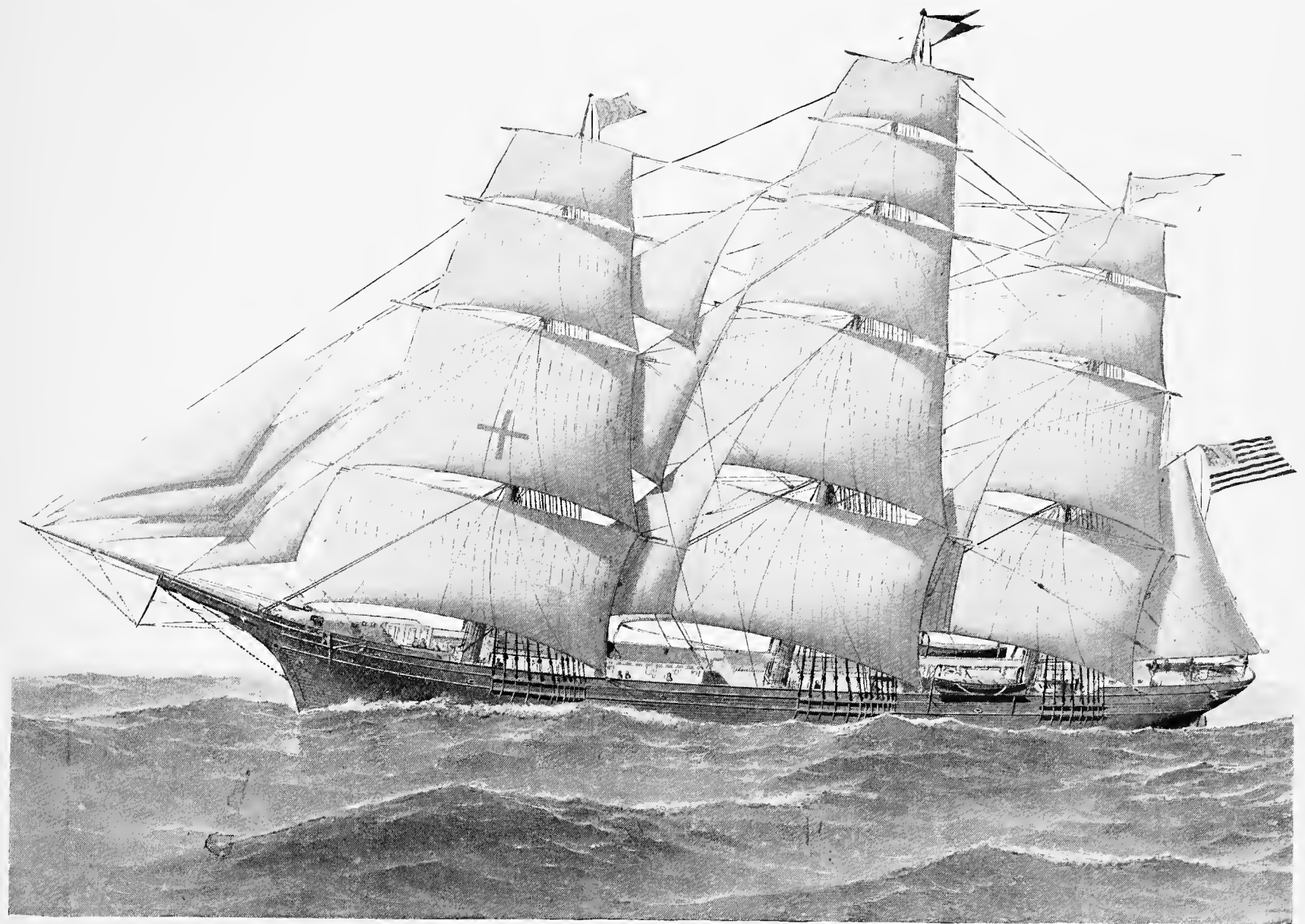

THE FAMOUS YANKEE PACKET SHIP DREADNOUGHT, WHICH WAS COMMANDED BY CAPTAIN S. SAMUELS.

with 2-inch hard pine. There are two steel commodious deck houses, the forward and larger one of which contains comfortable quarters for the crew, also galley. The smaller deck house aft is fitted up for the accommodation of all the apprentices and petty officers, also containing the carpenter's shop. There is a large full poop aft, in which is the captain's accommodation, and a saloon, 16 feet square, on the starboard side. The mess-room and pantry is in the center, while the officers' cabin and two spare staterooms are fitted on the port side, the sail-room occupying the space right aft. On top of the poop is a steel chart house which also forms a cabin entrance. The helmsman is protected by a steel hood, open on the forward end. A

large flying bridge is fitted, connecting the poop and topgallant forecastle, and proves a great convenience in bad weather. The scantlings of the vessel are equal to Lloyd's. The lower masts and topmasts are in one length, measuring 134 feet; the pole bowsprit, 67 feet long; the lower yards, 92 feet long, and the upper and lower topsail yards are all of steel. A large crane is fitted on each side of the bow for working the anchors. Though costing a little more than a wooden hull, the advantage which steel vessels always have over wooden ones in commanding freights, has made her as profitable as her big predecessors, Roanoke, Susquehanna, and Shenandoah. The steel plates and angles used in the construction of this vessel were imported

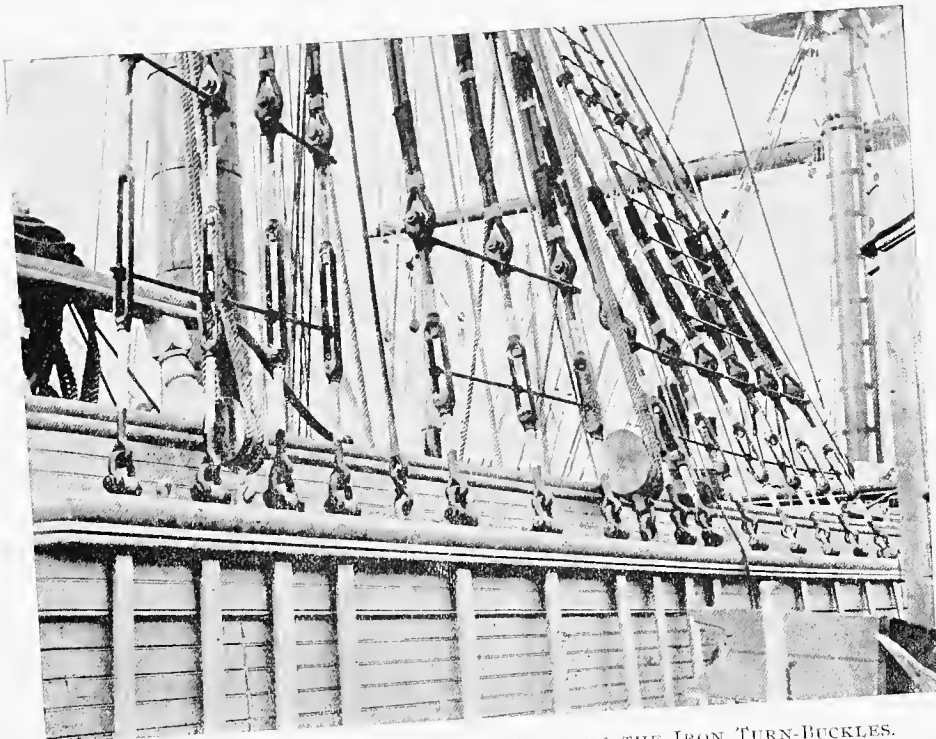

STANDING RIGGING OF THE ROANOKE, SHOWING THE IRON TURN-BUCKLES.



THE WOODEN SHIPENTINE ROANOKE.—Built by Arthur Sewall & Co., Bath, Maine.



THE GRANITE STATE.—A Typical American Wooden Sailing Ship.



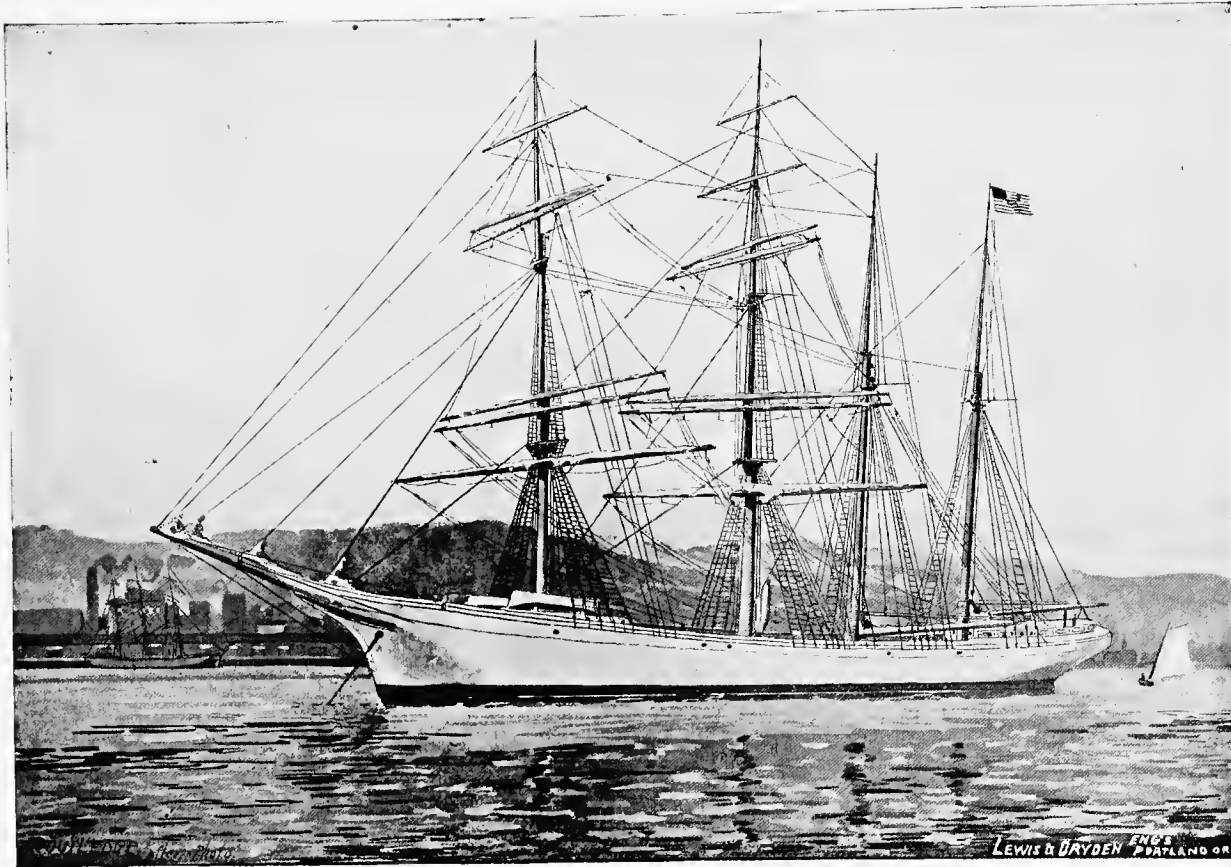

FOUR-MASTED WOODEN BARK OLYMPIC.—Built by the New England Company, Bath, Me.

from David Colville & Sons, of Motherwell, near Glasgow. A donkey engine of 20 horse-power works the ship's windlass by means of a messenger chain, and the same motive power will be utilized in foreign ports for discharging and taking on cargo. Her anchors weigh 6,300 pounds each. The crew consists of 24 men before the mast, two boatswains, three mates, cook, steward, carpenter, engineer and four boys. She is capable of making $13\frac{1}{2}$ knots an hour in a good breeze. We are not aware of the cost of the *Dirigo*, but a rough estimate would place the figures at \$150,000.

The Packet Ship *Dreadnought*.

This renowned ship was built at Newburyport, Mass., in 1853, by Wm. Currier and Jas. T. Townsend, for David Ogden, Gov. E. D. Morgan and Capt. Samuel Samuels, under the supervision of the latter. By the sailors she was nicknamed the "Flying Dutchman." She was what might be termed a semi-clipper, and possessed the merit of being able to bear driving as long her sails and spars would stand. She was 200 feet long between perpendiculars, 217 feet on deck, 40 feet beam, 26 feet deep; tonnage, o. m., 1,443; net, 1,227; carrying capacity, d. w., 1,700 tons. It has been said that with a strong leading breeze

and all sails drawing, nothing was ever allowed to pass the clipper *Dreadnought*, not even a steamer. Her first return trip was made in February, 1854. On that voyage she scudded into celebrity by reaching Sandy Hook as soon as the Cunard steamer *Canada*, which had left Liverpool one day earlier. In 1859, made the 3,000 miles from Sandy Hook to Rock Light, Liverpool, in 13 days and 8 hours; and in 1860, went from Sandy Hook to parallel of Queenstown, 2,760 miles, in the unequalled sailing time of 9 days and 13 hours. In April 1869, the famous ship left Liverpool in command of Capt. Mayhew, bound for San Francisco, and was wrecked on the morning of the Fourth of July on Cape Penas, N. E. of the Island of Terra del Fuego. She had a cargo of 2,000 tons. Her loss was occasioned by her having anchored nearer shore than was supposed, and when the breakers were discovered she was becalmed and drifted with the current. The crew, 34 in all, had hardly time to get into two boats which they succeeded in lowering, saving none of their effects but the clothes they had on, and not a mouthful of provisions. For days they subsisted on the shellfish which they gathered from the rocks at low tide. By day they pursued their course southward, toward the Straits of Maire, and on the 17th day after their wreck fell in with the Norwegian bark *General Birch*, whose captain, A. Amersden, treated them with all possible kindness and attention. The

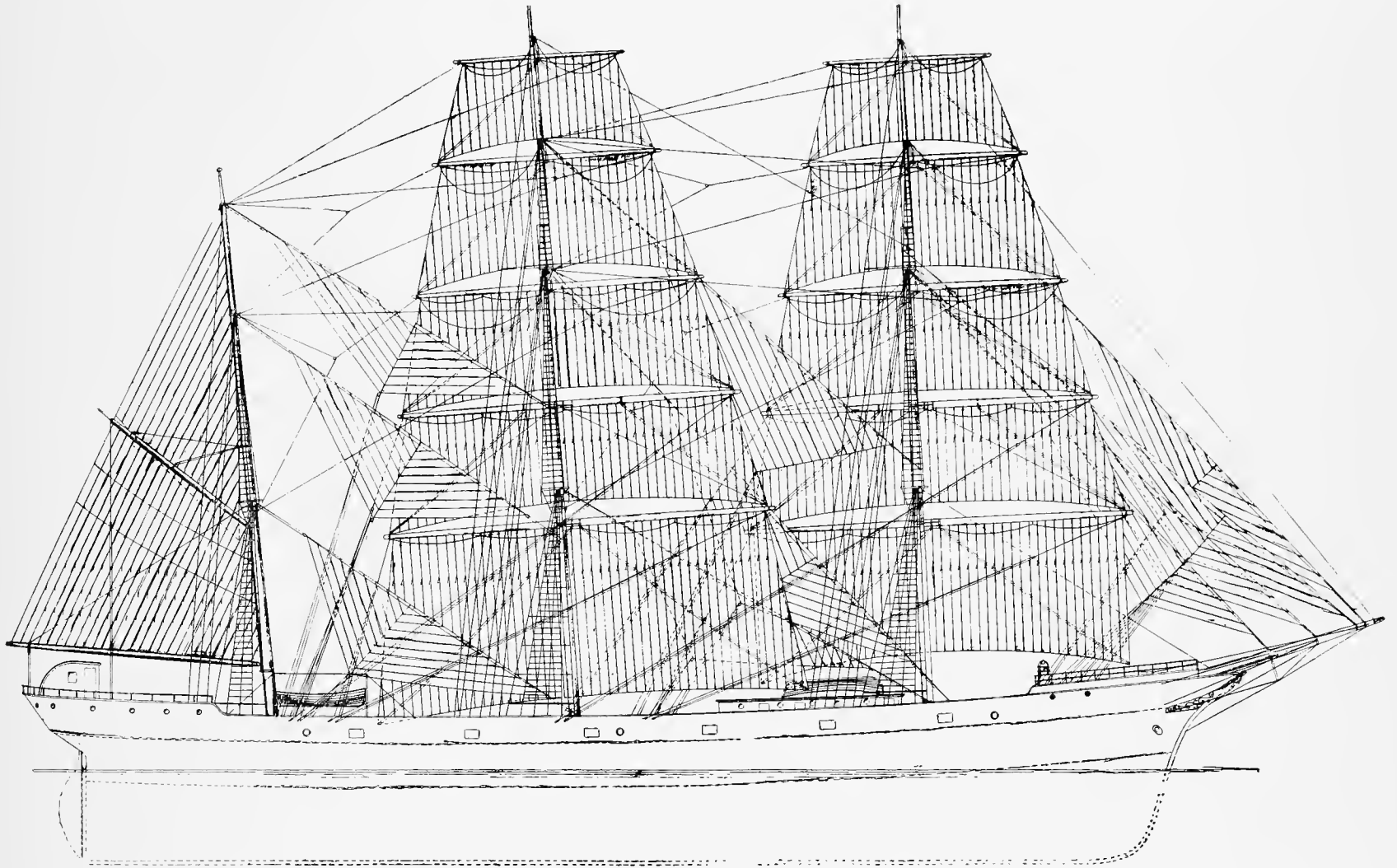

STEEL BARK PROJECTED BY CAPT. CHAS. H. NELSON, OF BOSTON, MASS.

Birch landed the sufferers at Talcahuano. Ten of them were left in the hospital at that port, and lost their toes, which were frost-bitten. Thus ignominiously ended the career of America's greatest and fastest western ocean passenger ship. The personality of Capt. Samuels is not less conspicuous than was the name and fame of his ship. He won an international reputation in command of the yacht *Henrietta*, in the ocean yacht race against the *Vesta* and *Fleetwing* in December, 1866. Capt. Samuels has added to his laurels by writing a book of life at sea in sailing ships, entitled, "From Forecastle to Cabin," published by Harper & Bros., New York. This book is the best picture of a sailor's life, outside of "Two Years Before the Mast," by Richard H. Dana. Capt. Samuels is now, and has been for the past six or seven years, one of the proprietors of the New York *Marine Journal*, of which Capt. George L. Norton is editor and manager. The *Dreadnought* was commanded by Capt. Samuels from the time she was built until 1863, covering the period of her career as a Liverpool packet. The *Dread-*

nought carried a fiery cross painted on her fore topsail, and was readily recognized at sea by this characteristic. The three following stanzas are from a ballad, entitled, "The *Dreadnought*," which was once the choice windlass and capstan song, or shanty, of both American and British packet ship sailors. The ballad contained some eight verses.

There's a saucy wild packet, and a packet of fame,
She belongs to New York, and the *Dreadnought's* her name;
She is bound to the westward where strong winds do blow,
Bound away in the *Dreadnought* to the westward we go.

Oh! the *Dreadnought's* a-bowling down the wild Irish shore,
Captain Samuels commands her as he's oft done before,
While the sailors like lions walk the decks to and fro,—
Bound away in the *Dreadnought* to the westward we'll go.

Here's health to the *Dreadnought* and to all her brave crew!
Here's health to Captain Samuels, and officers, too!
Talk about your flash packets, Swallow Tail and Blue Ball,
But the *Dreadnought's* the clipper to beat one and all.

American Wooden Shipentine Roanoke.

The first four-masted ship, of what we might call the new era of American wooden sailing ships, was built about the year 1874, by J. Henry Sears, of Boston, and called the Ocean King. This ship was fore-and-aft rigged on the jigger mast, as all four-masted American ships are. It is enough to swing fore, main and mizzen yards in tacking ship, and reef and furl sails on the three masts without adding another set of yards, which experience has proved are useless for practical purposes. All our American four-masters can be counted on the fingers of one hand. The Roanoke was built by Arthur Sewall & Co., of Bath, Me. Her length on the keel is 311 feet, and her length over all is 331 feet. Her extreme beam is 49.3 feet, and her depth 29.1 feet, and her draught 27 feet. Her main and mizzen lower masts are 92 feet high, and her fore lower mast is 91 feet high. Her lower spanker mast is 98 feet high. The Roanoke has loaded over 5,000 tons of general cargo. She carries a crew of about 40 men. The Shenandoah, a sister ship, is 3,258 tons register. The Rappahannock, which was burned, was 3,053 tons. The Susquehanna is another four-master of about 2,900 tons register. The half-tone cut of the Roanoke's rigging shows the modern wrought-iron turn-buckles now used altogether instead of the old-fashioned hemp lanyards. One man and a boy can now do the work of a whole watch in setting up the rigging, and can do it in less than one quarter of the time occupied by the old way. These turn-buckles were made by the Cleveland (Ohio) Forge and Iron Company.

The Four-Masted Bark Olympic.

The illustration represents the Olympic, the only four-masted bark afloat, and the only wooden sailing vessel capable of crossing the Atlantic or doubling Cape Horn with a clean-swept hold and without a pound of ballast of any kind in the same. This vessel was built in 1892 by the New England Co., of Bath, Me., for Capt. W. H. Besse, of New Bedford, Mass., and others. She carries double topgallant yards and a main skysail. Her deadweight capacity is about 2,300 tons; full capacity for lumber, 1,400,000 feet on 19 feet of water. Dimensions: Length, 224 feet; beam, 42 feet 2 inches; depth of hold, 21 feet. She is provided with two bow ports, 36 inches square, and two stern ports 32 inches square, to enable her to take in spars or long square timber. All the standing rigging, bobstays and jib guys are set up with screws or turn-buckles, no deadeyes or lanyards being used even for the topmast rigging. The Olympic spreads 80,000 square yards of canvas. Her fore and main yards are each 84 feet long; the hatches, three in number, fore, main and mizzen, are each 20 by 16 feet. Carries 235 tons of cargo to the foot. The vessel is especially fitted for the Oregon timber and spar trade. N. B. Sinclair and Benjamin Moore are owners with Capt. Besse, whose son, W. S. Besse, of New York, is the ship's agent at this port. The two most remarkable points about the Olympic are her rig and the fact that she can sail without ballast with skysail yard aloft, and still stand up as stiff as a church. The lower rigging is rattled down with galvanized gas pipe, which lasts as long as the shrouds, the latter being of best steel wire. The Olympic is 1,469 tons gross and 1,400 tons net register.

An American Steel Bark.

Some twenty years ago there was built by the Harlan & Hollingsworth Co., of Wilmington, Del., an iron bark called the Iron Age. Since then no iron vessel of that rig has been constructed in the United States. True it is that the lamented Commander Henry R. Goringe, of the U. S. Navy, constructed the iron ships T. F. Oakes and Clarence S. Bement, and



Steam Whaler in the Ice Pack "Boiling Oil."



Frozen in the Ice of Bering Sea.

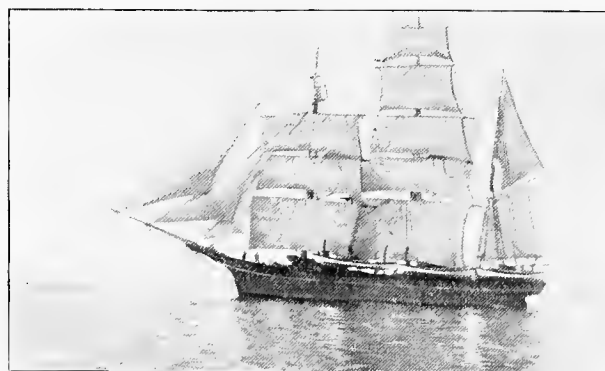

A Typical Whaling Vessel.

SCENES IN THE MODERN AMERICAN WHALING INDUSTRY.
Reproduced from Photographs taken on the spot.

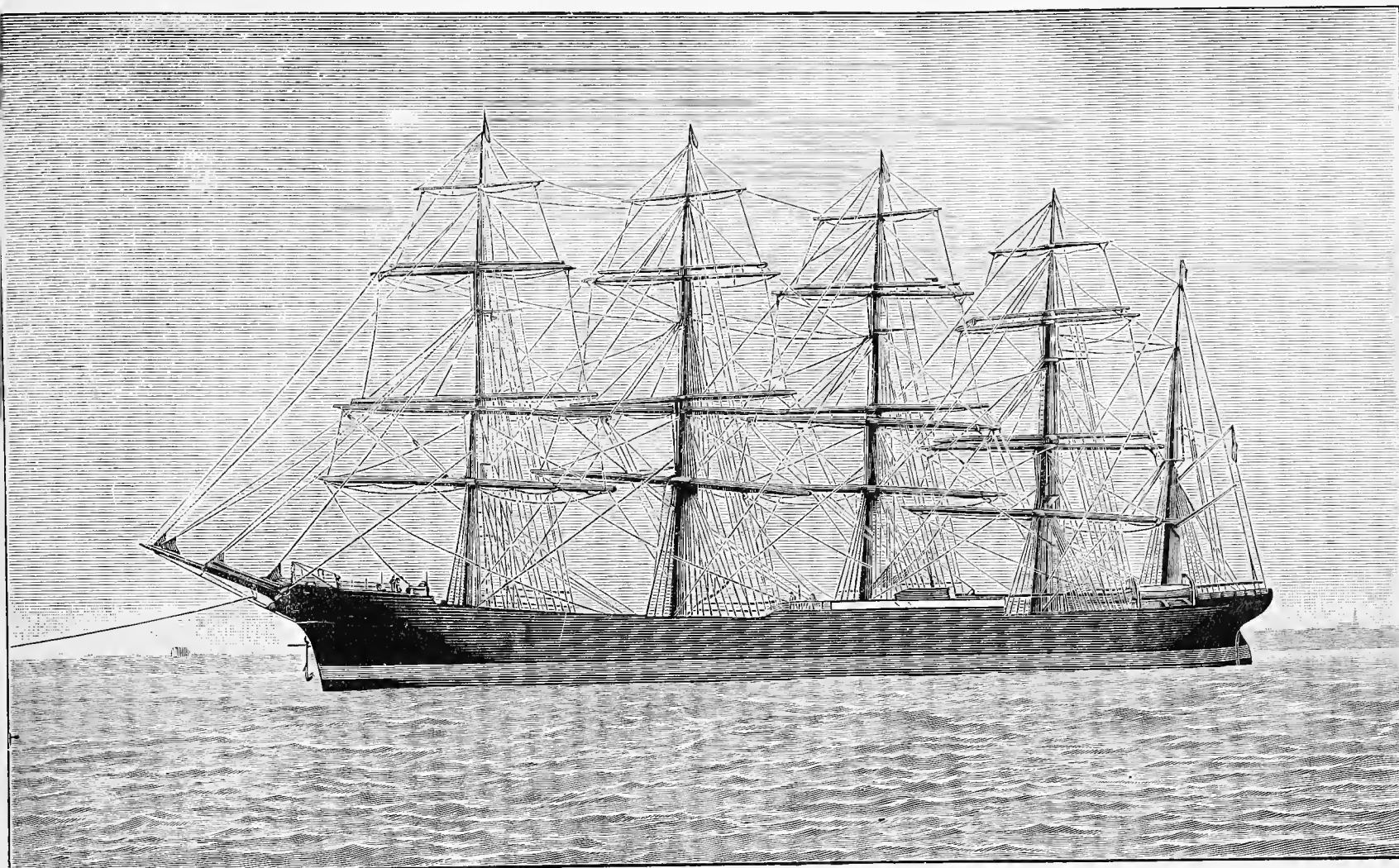

THE FIVE-MASTED STEEL SAILING SHIP POTOSI.

the iron schooner Red Wing, at the yards of the American Shipbuilding Co., in Philadelphia. One iron sailing ship, the Tillie E. Starbuck, was also built by John Roach, at Chester, Pa. These and the Dirigo complete the fleet of American iron sailing vessels. There is one man in New England, Capt. Charles H. Nelson, Boston, Mass., who thinks that the United States can turn out as good a specimen of a steel square-rigged vessel as any country in the world, and he has had plans drawn for the construction of a steel bark of 1,398 tons. Her estimated cost will be about \$100,000. A look at the plans will convince the most sceptical of the ultimate success of the bark as far as her lines, carrying capacity and construction go. Her length will be 220 feet, 36 feet 8 inches breadth, 22 feet 6 inches depth.

The Largest Sailing Vessel in the World.

A little more than three years have passed since the proud

German five-master Maria Rickmers started from an English port on her second voyage, from which she never returned. Only one sailing vessel of similar dimensions has been built since (we refer to the French five-master La France); but now Germany has become the possessor of the largest sailing vessel in the world. On June 8, 1895, the five-master Potosi was launched from the yards of Tecklenborg, and made her first voyage to Iquique, a distance of 11,000 miles, in 72 days, arriving at that port early in October. The vessel is owned by the well-known Hamburg house of F. Laeisz.

The Potosi is about 426 feet 6 inches long, 52 feet 5 inches broad, and 32 feet 9 inches deep. She has a capacity of 6,150 tons, or 550 tons more than that of La France. The uninitiated may obtain a better idea of the great size of this vessel from the following figures: 5,511,500 pounds of iron were used in its construction, and the vessel, which will make regular trips to the western coast of South America for saltpeter, can carry about 13,227 bags of this salt.

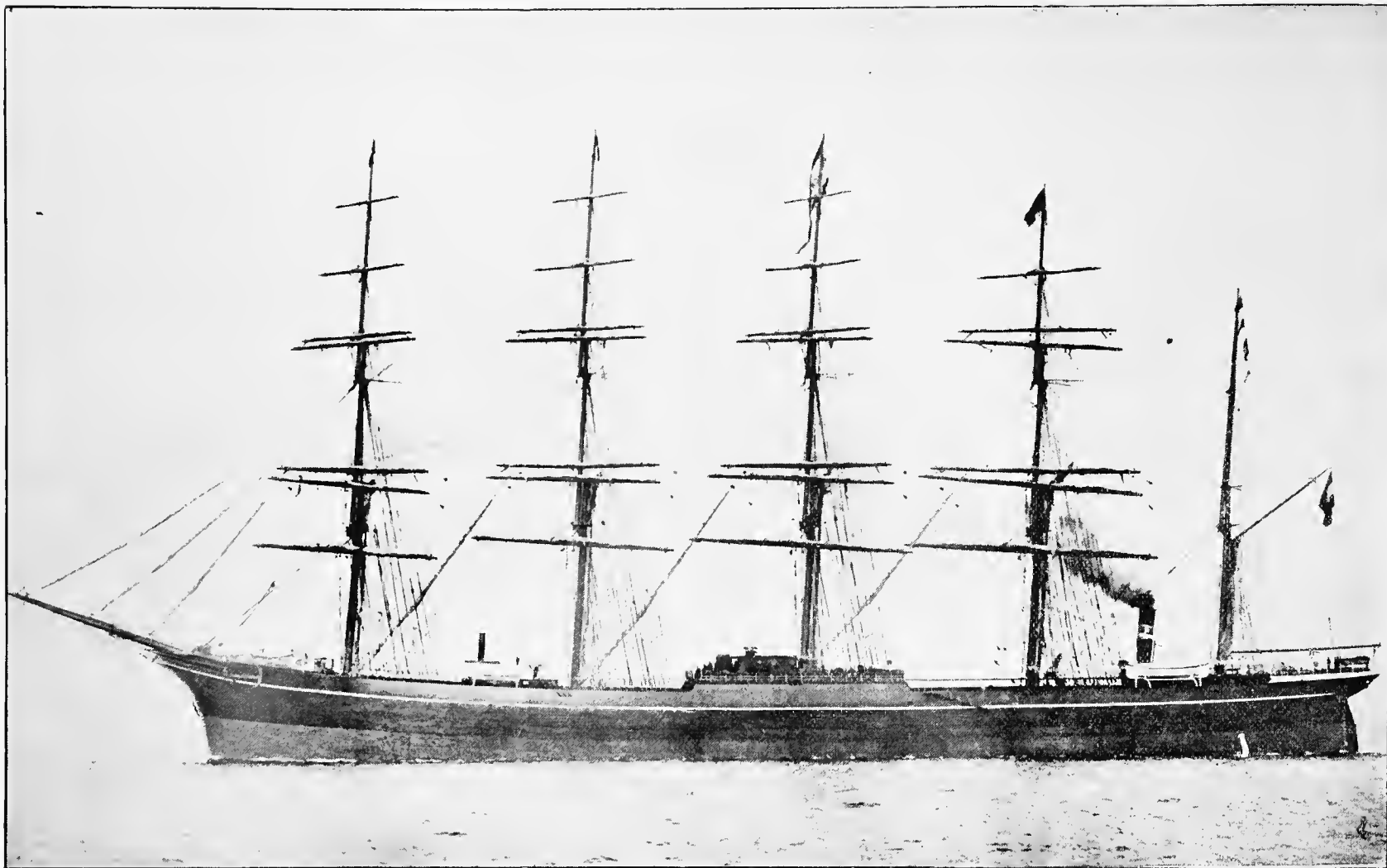

FIVE-MASTED STEEL SHIP MARIA RICKMERS —Built by Russell & Co., Glasgow.

Five-Masted Ship Maria Rickmers.

This auxiliary steamer was built in 1892 by Russell & Co., of Glasgow, for the Rickmers, of Bremen. Her dimensions were: Length over all, 375 feet; on water line, 360 feet; beam, 48 feet; depth, 25 feet 8 inches. Her tonnage was 3,813 tons, gross; carrying capacity, 5,850 tons. She was fitted with a double bottom and deep midship water tanks, capable of holding 1,300 tons water ballast. Her auxiliary engine was of the triple-expansion type, 16, 26 and 42 by 27 inches, of 780 indicated horse-power, built by Kincaid & Co., of Greenock. After the ship had made a couple of voyages, she went to Rangoon, loaded rice, and was never heard from after leaving port. Auxiliary steamers have been tried in the United States, but have always proved a failure.

The Steel Shipentine Somali.

It is scarcely necessary to inform any old sailor that the Somali is an English ship. Look at the cut of her jibs, top-sails and topgallant sails. Dimensions: Length, 329.9 feet; beam 47 feet; depth, 27 feet; registered tonnage, 3,537 tons. She carries a crew of 38, all told, including four apprentices. Her three forward masts measure 208 feet from deck to truck, and the jigger mast 162 feet; spanker boom, 47.6 feet; spanker gaff, 36 feet; bowsprit, 60 feet from the knightheads out; the lower yards 90 feet in length. Her six topgallant yards are each 70 feet in length. The anchors weigh about three tons each. The Somali loaded in San Francisco 5,700 tons of wheat on a draught of 23 feet, with a freeboard of 6 feet 8 inches. She



THE 3,537-TON FOUR-MASTED BRITISH SHIPENTINE SOMALI.—Built by Russell & Co., Port Glasgow.

is owned by the Hillsboro Shipping Co., of Liverpool; was built in 1892 by Russell & Co., of Port Glasgow.

Four-Masted Ship Falls of Earn.

The dimensions of this steel ship are 302.2 feet in length, 42.1 feet beam and 24.5 feet depth, 2,279 tons net; and the weight of ship complete, 1,680 tons. It may be noticed that all of the lower masts are much the same length, *viz.*, 90 feet by 32 inches in diameter, except the jigger mast which is 85.3 feet by 30 inches in diameter. The rake of the masts is as follows: Fore, $\frac{3}{4}$ inch to the foot; main, $\frac{7}{8}$; mizzen, 1 inch, and jigger $1\frac{1}{8}$ inches. The stave of the bowsprit is $4\frac{1}{4}$ inches per foot, the foremast being stepped far enough forward to obviate the necessity of a jib boom. The lower yards, excepting the jigger, are square, the latter being 71 feet 6 inches. The total spread of canvas is 55,520 square feet.—*Cleveland Marine Record*.

The British Shipentine Afghanistan.

It is not an easy matter to obtain a photograph of a large ship under full sail. It is only upon the broad ocean that her full canvas is ordinarily brought into play. It was at the beginning of a voyage from the outer harbor of Boston that our artist correspondent, H. L. Stebbins, happily succeeded in cameraizing the four-masted ship Afghanistan, and from his photograph our engraving has been made.

The Afghanistan is a British ship, built in 1888, of iron, at Stockton-on-Tees, by Richardson, Duck & Co. Her gross register is 2,286 tons. Length, 291 feet 2 inches. Beam, 42 feet 1 inch. Depth of hold, 24 feet 3 inches. She is provided with steam hoisting apparatus and all the modern improvements. At present the ship is in Chinese waters.—*Scientific American*.

R. P. Joy's Schooner Yacht Pilot.

This wooden racing schooner yacht was designed by Richard P. Joy, of Detroit, Mich. Dimensions: Length over all, 40 feet; load water line, 28 feet; overhang, aft, 7 feet; forward, 5 feet; draught, 3 feet 8 inches; least freeboard, 2 feet; sheer, forward, 2 feet; aft, 8 inches; displacement, fresh water, $6\frac{1}{2}$ tons; lead keel, $2\frac{1}{2}$ tons; lateral plane, without board, 81.65 square feet; with board, 97 square feet; lower canvas, 839 square feet. The Pilot was designed for a cruiser, and has comfortable accommodations for six people. She has proved herself a most seaworthy boat and a fast sailer in several cruises on the Lakes. The hull is divided into five water-tight compartments by four bulkheads, which greatly reduces the danger of sinking in case a hole is stove in the boat. Her hull is of solid construction, the keel, stem and stern post being of oak. The frames also are of oak, steam bent. The planking is double, of pine, inside $\frac{3}{4}$ inch, laid diagonally, outside $\frac{3}{4}$ inch. This type of boat is usually slow in stays, as evidenced by the behavior of the Vigilant. To

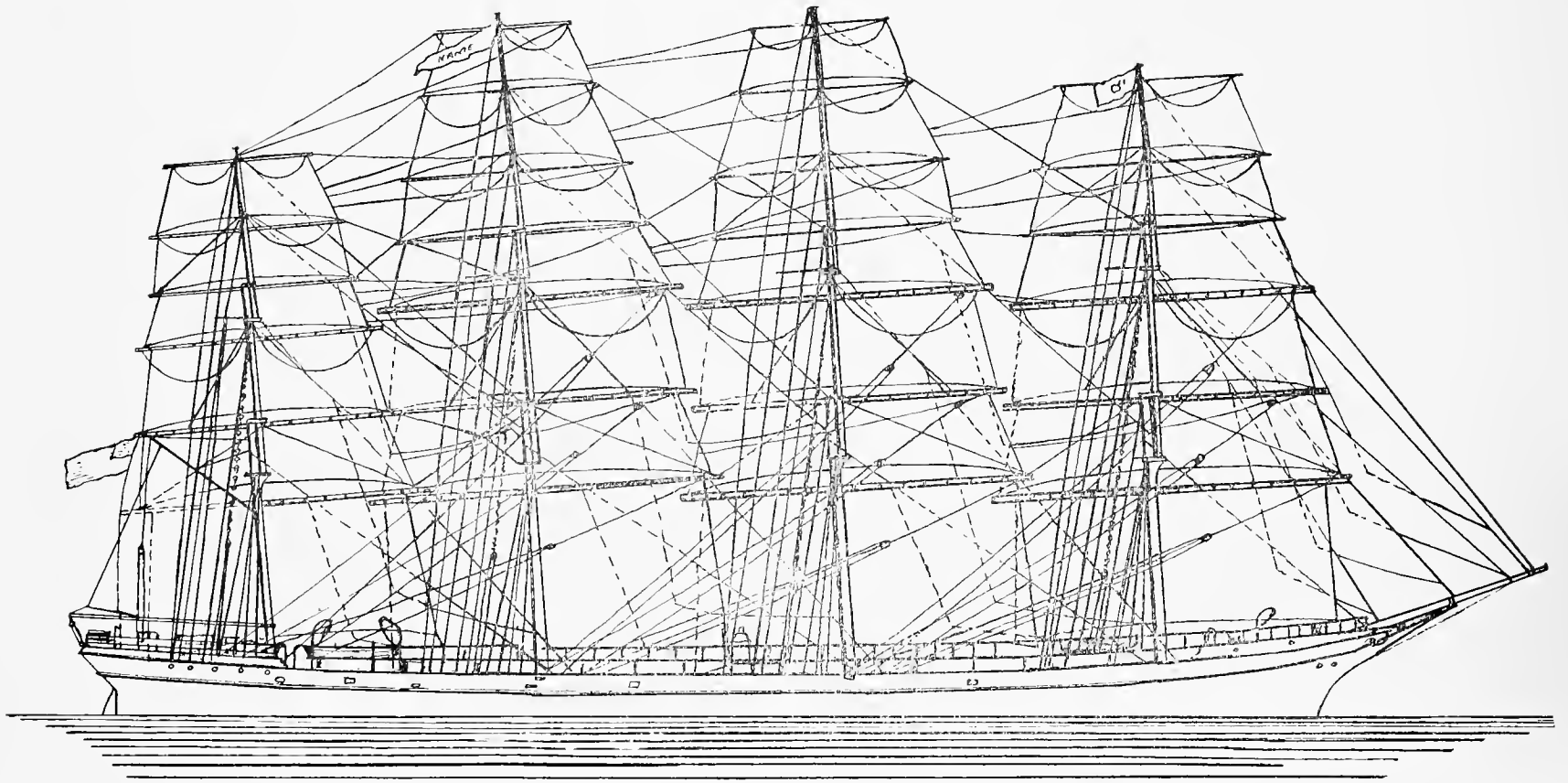

THE FOUR-MASTED BRITISH STEEL SAILING SHIP FALLS OF EARN.—Built by Russell & Co., Greenock, Scotland.

overcome this fault the deadwood has been cut away aft in Pilot, and she is remarkably quick in coming about. The center of effort is so figured that she is perfectly balanced without the foresail or with the foresail alone, which is a great convenience in case of a sudden squall, as she can immediately be brought under shortened canvas without reefing. The yacht was built by the Detroit Boat Works, being launched on July 21, 1893, just two months from the time her keel was laid. The work of construction was very thoroughly done, and the yacht has proved a credit to her clever designer and owner, who, by the way, is one of the most enthusiastic friends and advocates of American shipping.—*Forest and Stream*, N.Y.

Auxiliary Steam Yacht Utowana.

Was built in 1891, by Neafie & Levy, Philadelphia, Pa., for W. W. Durant, New York, from plans of J. Beavor Webb,

Naval Architect and Engineer, of this city. She is of steel. Dimensions: 155.3 feet long, 27.8 feet beam and 16.5 feet deep. Her motive power is a triple-expansion engine, 10, 15 and 25 inches diameter of cylinders by 20 inches stroke, of about 340 indicated horse-power. Hackworth valve gear has been adopted. She has one Scotch boiler of about 10½ feet diameter by 9 feet long, with two furnaces.

The Steel Schooner Yacht Lasca.

This centerboard yacht was built in 1892, by Henry Piegras, City Island, N. Y., for John E. Brooks, New York, from plans of A. Cary Smith. She is 121 tons gross, and 115 tons net. Length, 106 feet; beam, 23 feet; depth, 11.5 feet.

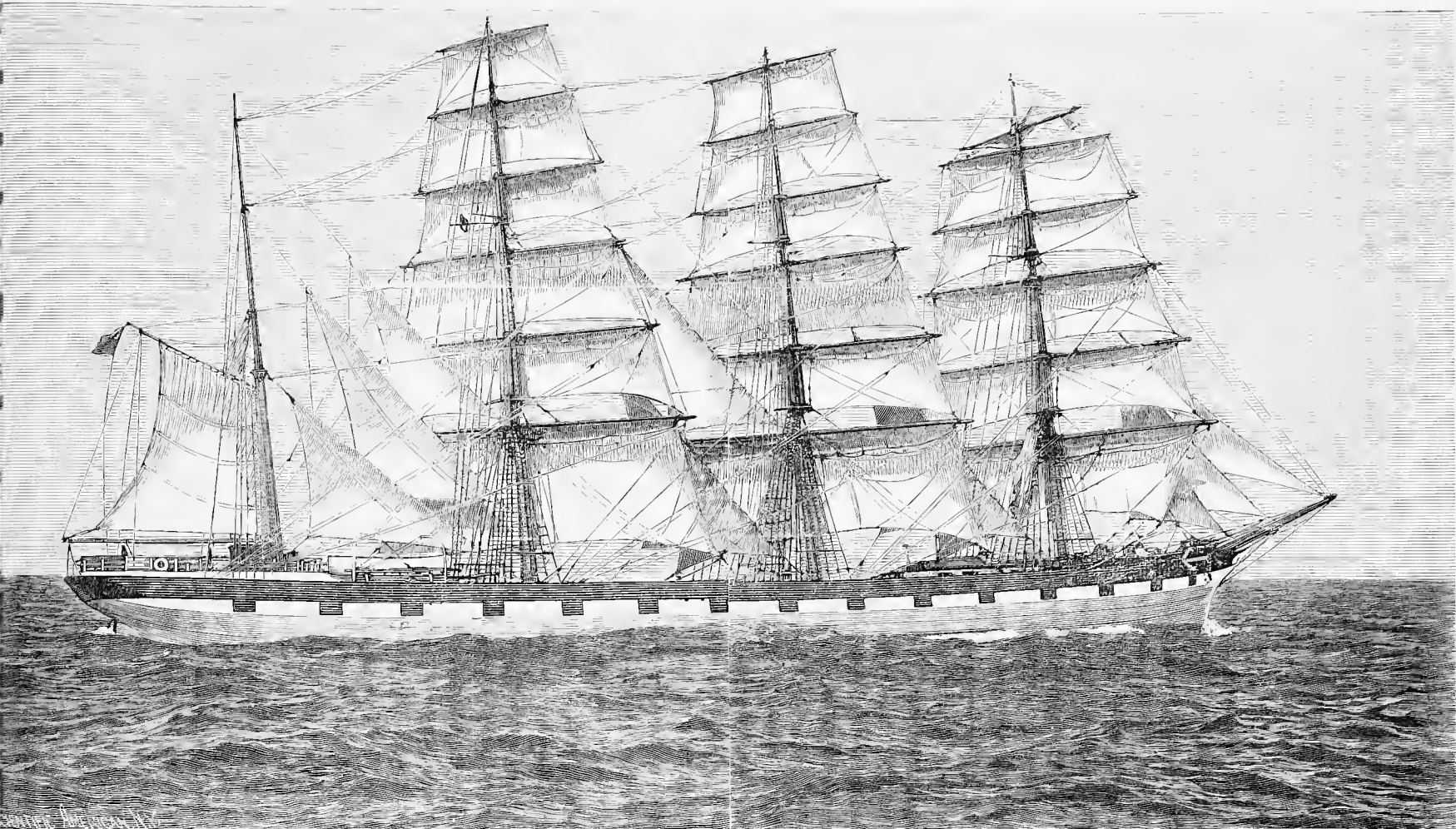

THE BRITISH IRON SHIPENTINE AFGHANISTAN.—Having Painted Ports, old Man-of-War Style.

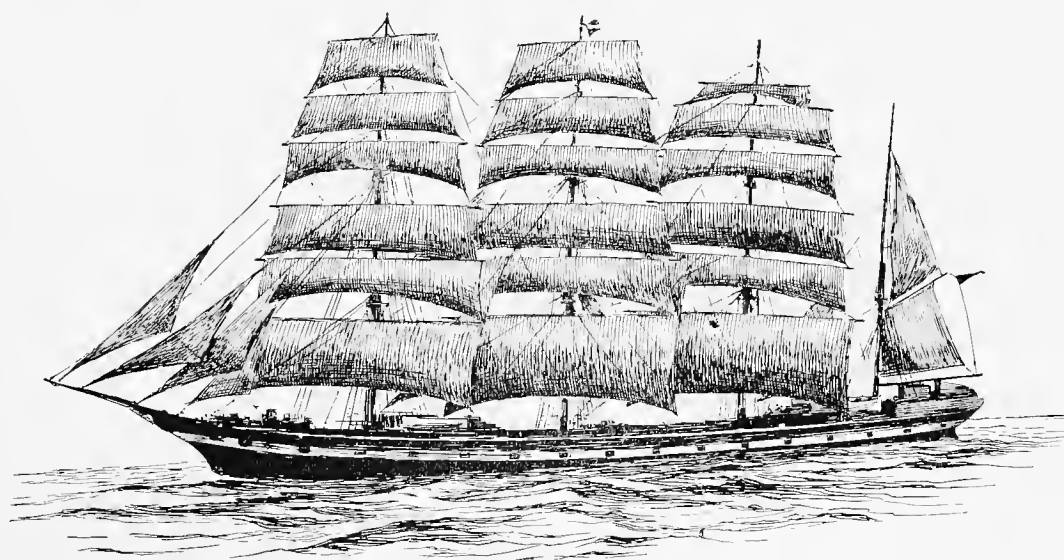

THE BRITISH STEEL SHIPENTINE COSMOPOLITAN.

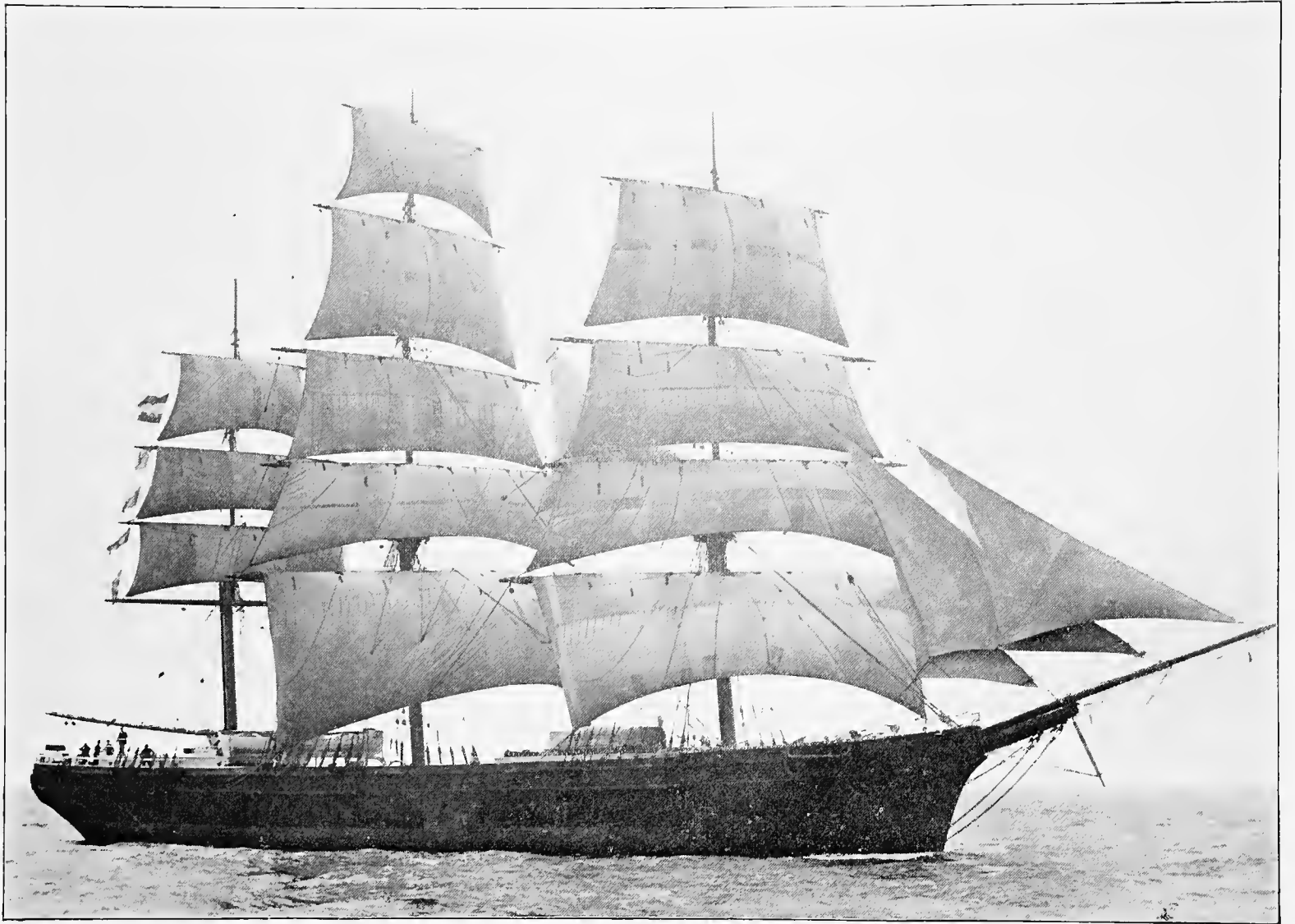

NO FORE OR MIZZEN ROYAL FOR THE BOYS TO LOOSE OR FURL ON THIS SHIP.



BOW VIEW OF AN OLD BRITISH SHIP, THE CALCUTTA, WITH STUDDING SAILS SET.

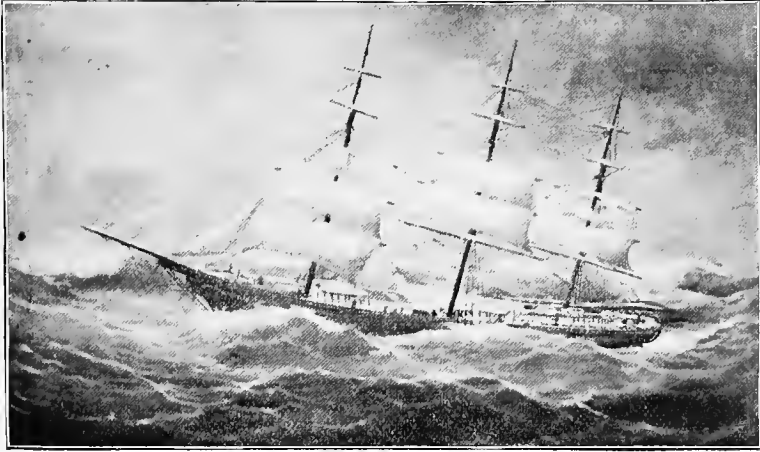

AMERICAN CLIPPER SHIP SPARTAN RUNNING BEFORE A GALE

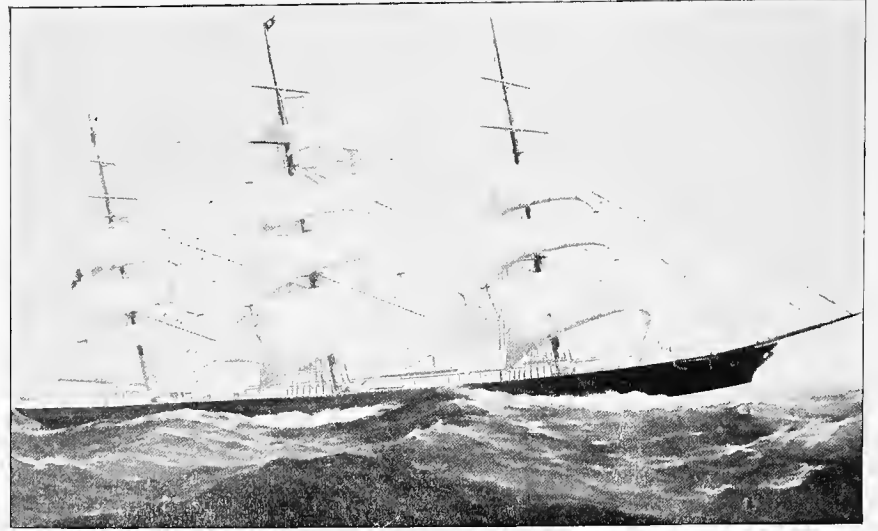

THE BRITISH IRON CLIPPER SHIP GARFIELD.

Reefing Topsails.

THREE hand-spike raps on the forward hatch,
A hoarse voice shouts down the fo'castle dim,
Startling the sleeping starboard watch,
Out of their bunks, their clothes to snatch,
With little thought of life or limb.

"All hands on deck! d'ye hear the news?
Reef topsails all—'tis the old man's word;
Tumble up, never mind jackets or shoes!"
Never a man would dare refuse,
When that stirring cry is heard.

The weather shrouds are like iron bars,
The leeward backstays curving out,
Like steely spear-points gleam the stars
From the black sky flecked with feathery bars,
By the storm-wind swerved about.

Across the bows, like a sheeted ghost,
Quivers a luminous cloud of spray,
Flooding the forward deck, and most
Of the waist; then, like a charging host,
It rolls to leeward away.

"Mizzen topsail, clew up and furl;
Clew up your main course now with a will!"
The wheel goes down with a sudden whirl,
"Ease her, ease her, the good old girl,
Don't let your head sails fill!"

"Ease off lee braces; round in on the weather;
Ease your halyards; clew down, clew down;
Haul out your reef tackles, now together!"
Like an angry bull against his tether,
Heave the folds of the topsails brown.

"Haul taut your buntlines, cheerly, men, now!"
The gale sweeps down with a fiercer shriek.
Shock after shock on the weather bow
Thunders the head sea, and below
Throbbing timbers groan and creak.

The topsail yards are down on the caps;
Her head lies up in the eyes of the blast;

The bellying sails, with sudden slaps,
Swell out and angrily collapse,
Shaking the head of the springing mast.

Wilder and heavier comes the gale
Out of the heart of the Northern Sea;
And the phosphorescent gleamings pale
Surge up awash of the monkey rail
Along our down-pressed lee.

"Lay aloft! lay aloft, boys, and reef,
Don't let my starbolines be last."
Cries from the deck the sturdy chief;
" 'Twill take a man of muscle and beef
To get those ear-rings passed."

Into the rigging, with a shout,
Our second and third mates foremost spring;
Crackles the ice on the ratlines stout,
As the leaders on the yards lay out,
And the footropes sway and swing.

On the weather end of the jumping yard,
One hand on the lift, and one beneath,
Grasping the cringle, and tugging hard,
Black Dan, our third, grim and scarred,
Clutches the ear-ring for life or death.

"Light up to windward," cries the mate,
As he rides the surging yard arm end,
And into the work we threw our weight,
Every man bound to emulate
The rush of the gale, and the sea's wild send.

"Haul out to leeward," comes at last,
With a cheering from the fore and main;
"Knot your reef-points, and knot them fast;"
Weather and lee are the ear-rings passed,
And over the yard we bend and strain.

"Lay down men, all; and now with a will,
Swing on your topsail halyards, and sway;
Ease your braces and let her fill,
There's an hour below of the mid-watch still,
Haul taut your bowlines—well all—belay!"

—Walter Mitchell.

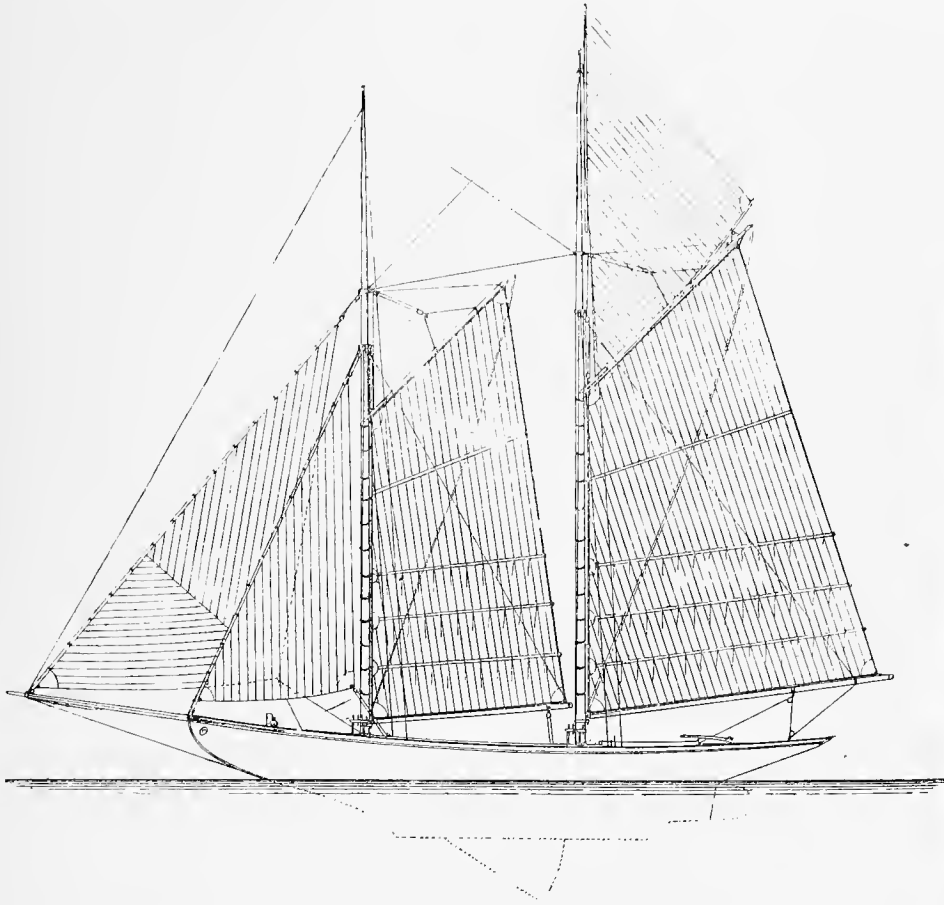

SAIL PLAN OF RICHARD P. JOY'S SCHOONER YACHT PILOT.

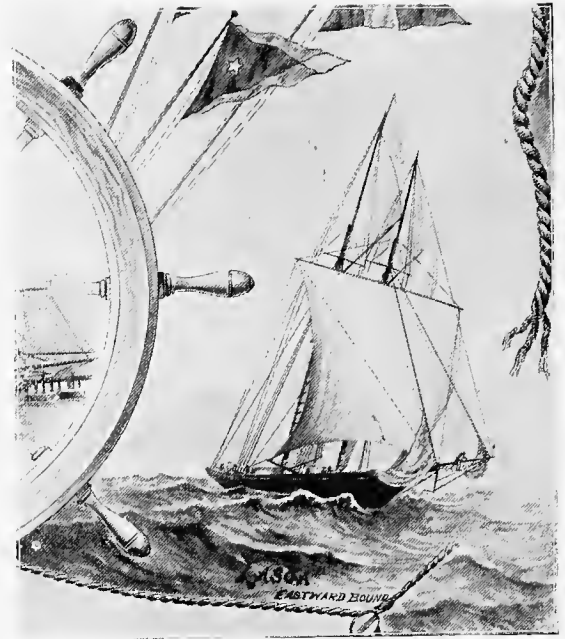

THE STEEL SCHOONER YACHT LASCA.

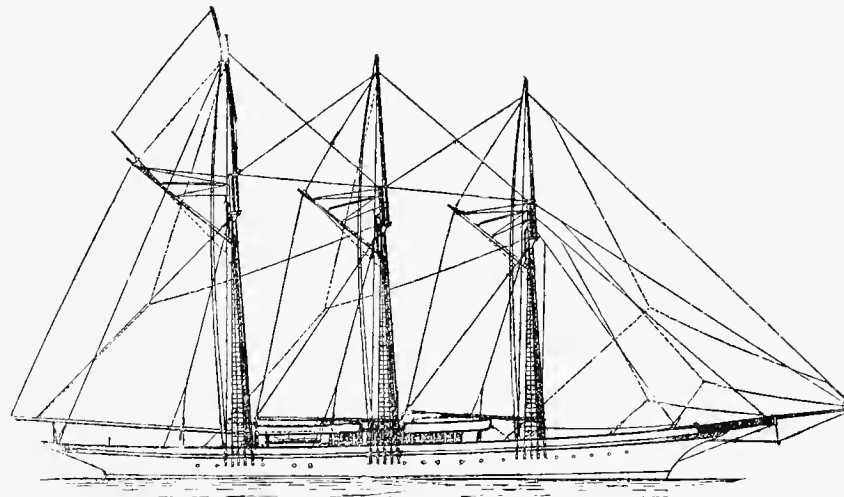

AUXILIARY STEAM YACHT UTOWANA.

The French Schooner Yacht Velox.

Now that England and America's attention is once more attracted to schooner yachts through the regattas for this kind of vessel, it may be interesting to publish the plans of a thoroughly French yacht which, although dating several years back, gives no leeway to similar foreign yachts. Built in Havre in 1875 by Augustin M. Normand, who obliged us with the plans, the Velox shows remarkable improvements and special features, showing a great advance over foreign constructions, as these novel forms were only applied later to a number of celebrated foreign yachts in her wake. Mr. Chevreux, in an elaborate article, published in *The Yacht* of April 13, 1895, has, moreover, brought out forcibly these characteristics which are found in certain racing yachts recently built in England. The outlines of the Velox, a combination of those then in use partly in England and in America, call at first for stability of ballast and for width of water line. The hull of the Velox is, therefore, in reality a conglomeration of two hulls brought together

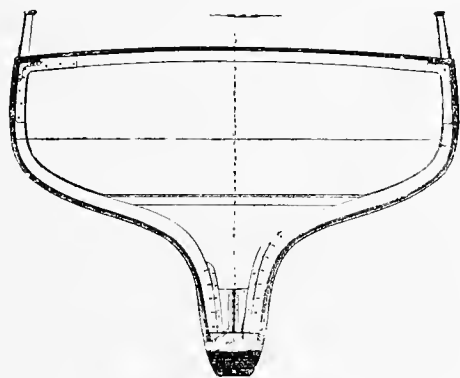

by softened curves, a broad hull with a weak depth on the lines of the celebrated Sappho and under that upper one another very narrow one, very high, intended to receive the ballast. The length of the second receptacle is so great, in proportion to its width, that its resistance is hardly more than the surface friction, and, notwith-

standing the capacity, is such that it can accommodate in a low draught, without injuring the stability or solidity, all the ballast necessary. The center volume is placed at a slight distance from the water line and the displacement rather lessened, so that the height of the metacenter (half center) above the center (which is inversely proportionate of the displacement) becomes considerable. The metacenter is located 1 meter and 42 centimeters above the water line. This is of exceptional value for a yacht having a great stability of weight. It will be seen what enormous distance from the center of gravity to the metacenter could be possibly obtained if the total of the ballast was lead and if the lower hull was consequently reduced. The low displacement in proportion to the volume of freeboard, allows the ship to rise very easily with the wave, and the nautical qualities are very good indeed. The board lines are composed of two diagonal and one longitudinal line. The first, running from front to rear, are only present in the center part. The second, running in an opposite direction, covers the ends in connection with a longitudinal outer layer. There are, therefore, three thicknesses of very thin woodwork in the middle and only two at the ends. These layers, powerfully riveted, form a surface as rigid as a metallic hull. It was also possible to allow a considerable distance between frames which admitted of a very light construction. Iron stanchions, inserted into the sides, bind the bridge and frame and prevent a deformation of the transversal lines.

The keel is very large (96 cm.), hanging free in the center

and supports a leaden keel. The yacht is not at all intended for racing, and, moreover, the proportion of lead in the total make-up of the ballast is exceptionally weak (25½ tons on 87 tons of total weight). Yet the vessel carried very readily one of the greatest expanses of canvas of any existing yacht. Important modification would have been necessary if it was intended to apply the same system of outlines to a racing yacht; but it appears that the plan gives a maximum of carrying power and stability, which is the intrinsic motive power of a sailing yacht, as it conditions the quantity of canvas. The Velox is by her dimensions, qualities and beauty of shape before all a high sea vessel and compares advantageously with the best English and American yachts of her type. Let us quote by comparison now as to yachts of her kind, more recent constructions, like the *Ambassadors*; the fine schooner *Constellation*, by Burgess; *Yampa*; *Alcæ*; and in England, *Enchantress*, *Cetonia*, *Waterwitch*, etc. Let us compare the Velox with the *Coronet*, which dates but from 1886, and was built by C. & R. Poillon, Brooklyn, N. Y.

	VELOX.	CORONET.
Total length.	138 feet 6 inches.	133 feet
Length, load water line,	123 " 14 "	123 "
Beam,	23 " 7½ "	27 "
Draught,	12 " 9¾ "	12 " 6 inches.
Length of foremast,	95 " 9½ "	91 "
" mainmast,	51 " 6¾ "	36 "
" main boom,	69 " 2½ "	63 "
Ballast,	87 tons.	126 tons.
Surface of canvas,	1,146.58 yards.	923 1-5 yards.
Displacement,	249.20 tons.	277 tons.

Following is a key to the letters shown in the plan of the interior of the Velox: *A*, owner's cabin; *B B*, cabins; *C*, toilet; *D*, hall; *F*, saloon; *G*, dining-room; *H*, officers' mess; *I*, captain's room; *J J*, bunks; *M*, buffets; *N*, pantry; *O*, second officer's cabin; *P*, lockers; *Q*, cook's cabin; *S*, kitchen; *T*, wash-room; *U*, quartermaster's room; *V*, mailroom.—*Le Yacht*, Paris.

A Pilot Boat for Fernandina, Fla.

A. Cary Smith designed this pilot boat, of the following dimensions: Length over all, 93 feet; length on load water line, 72 feet; beam, 20 feet; draught of water, 10 feet 10 inches. This boat is a wide departure from the ordinary pilot boat, but no more so than those the genius Geo. Steers used to build compared to the boats of that day. It has been shown that the modern yacht far outclasses her elder sisters in beating to windward in a sea way, not only in sail carrying power, but in getting over the water instead of digging into it; and in running in a bad sea the modern overhang is much superior to the old short flat counter.

Anyone who has anchored in a tide sea "stern to" knows what it means when a sea strikes the short, flat counter stern of the old type. The stern overhang has always been held to be a great detriment in the judgment of seafaring men, but this judgment was formed on the prevalent flat counter stern, and when some years ago the owner of the steam yacht *Meteor* consulted Mr. Smith about putting on a long overhang on the stern of that yacht, the idea was condemned by all seamen, but not withstanding this, Mr. Smith put a stern on that measured 20 feet from the inner post. The captain of the boat, on his return from a trip to the West Indies, gave his opinion

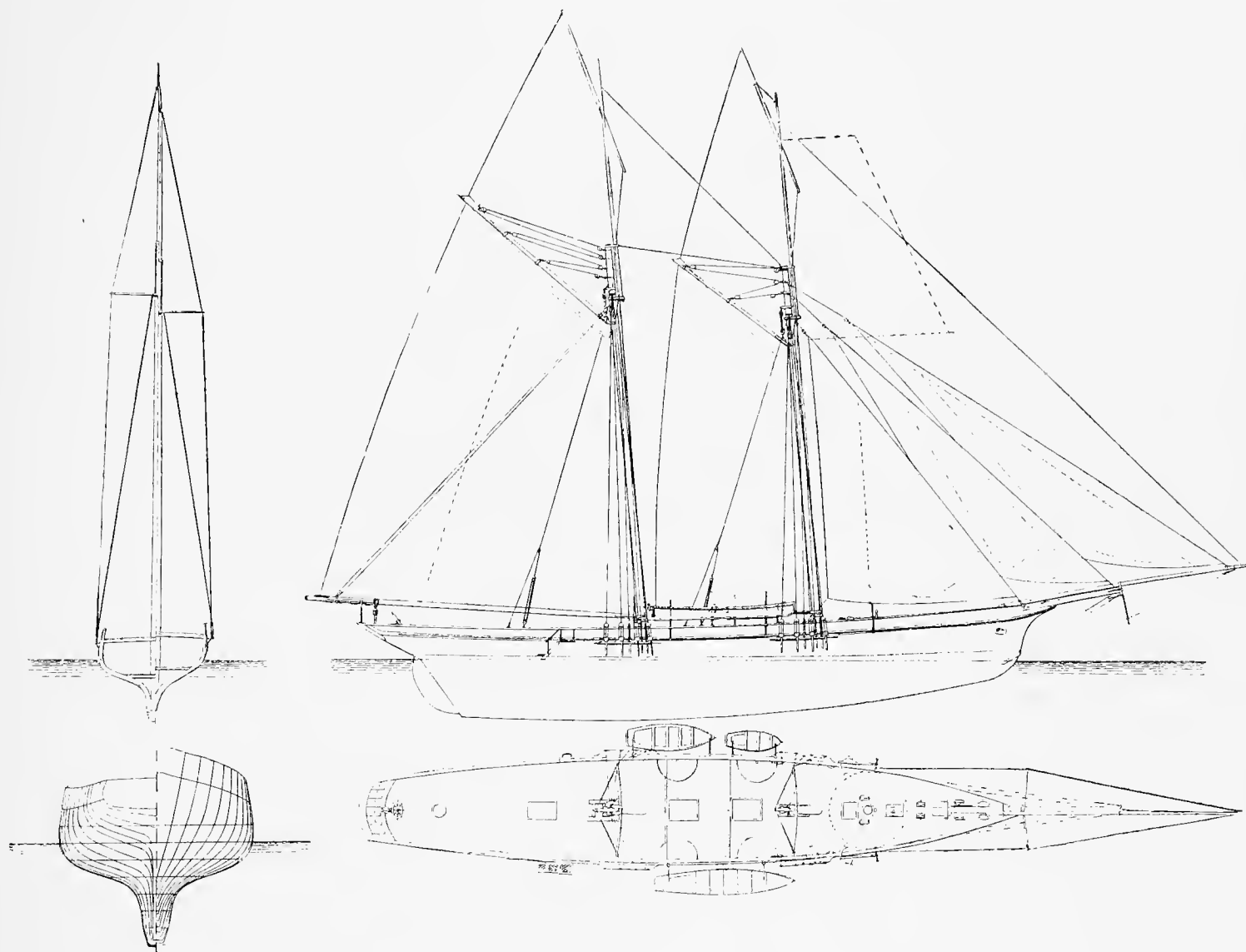

THE CELEBRATED FRENCH SCHOONER YACHT VELOX.

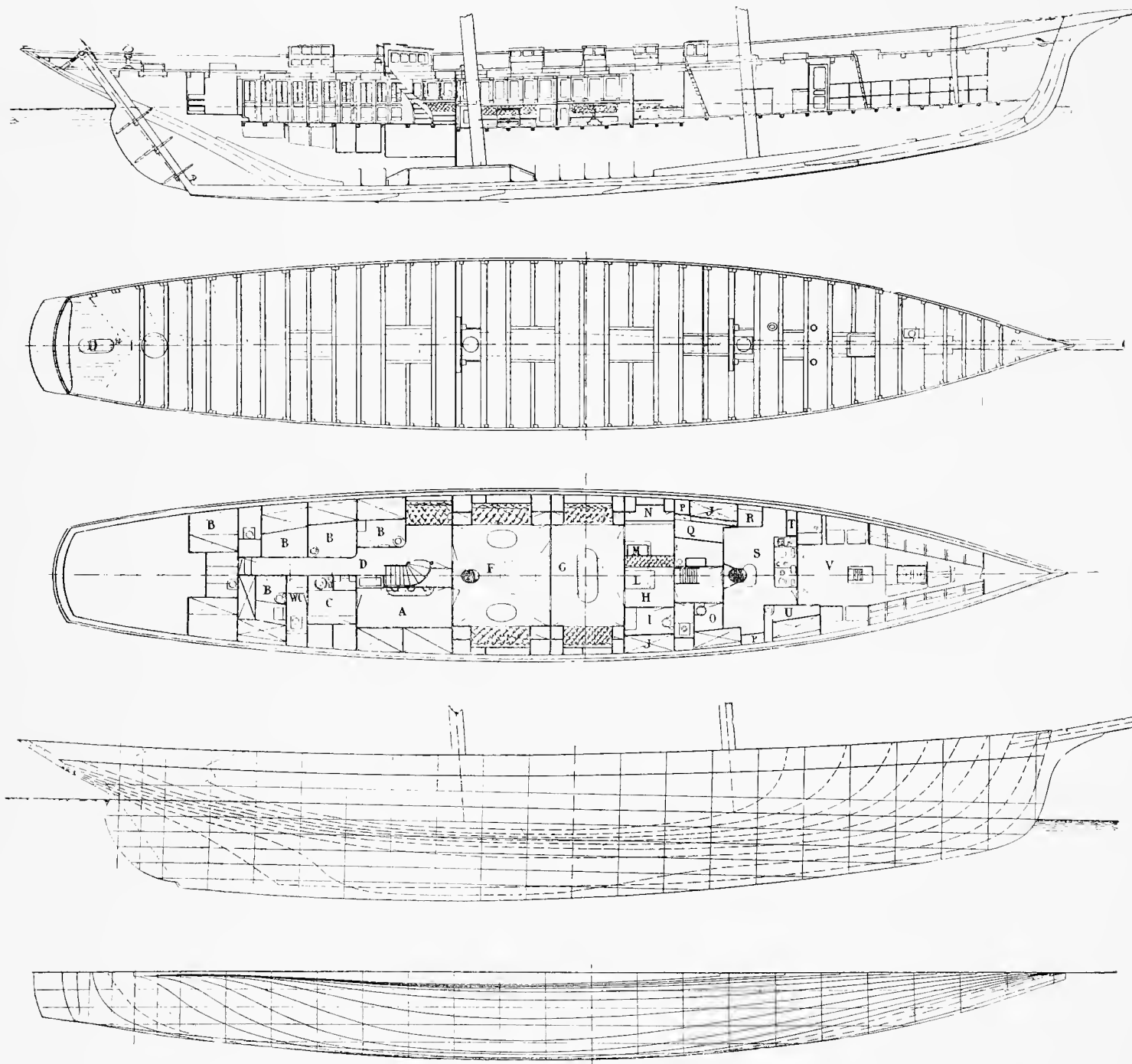

THE CELEBRATED FRENCH SCHOONER YACHT VELOX.—Built by M. A. Normand, Havre.

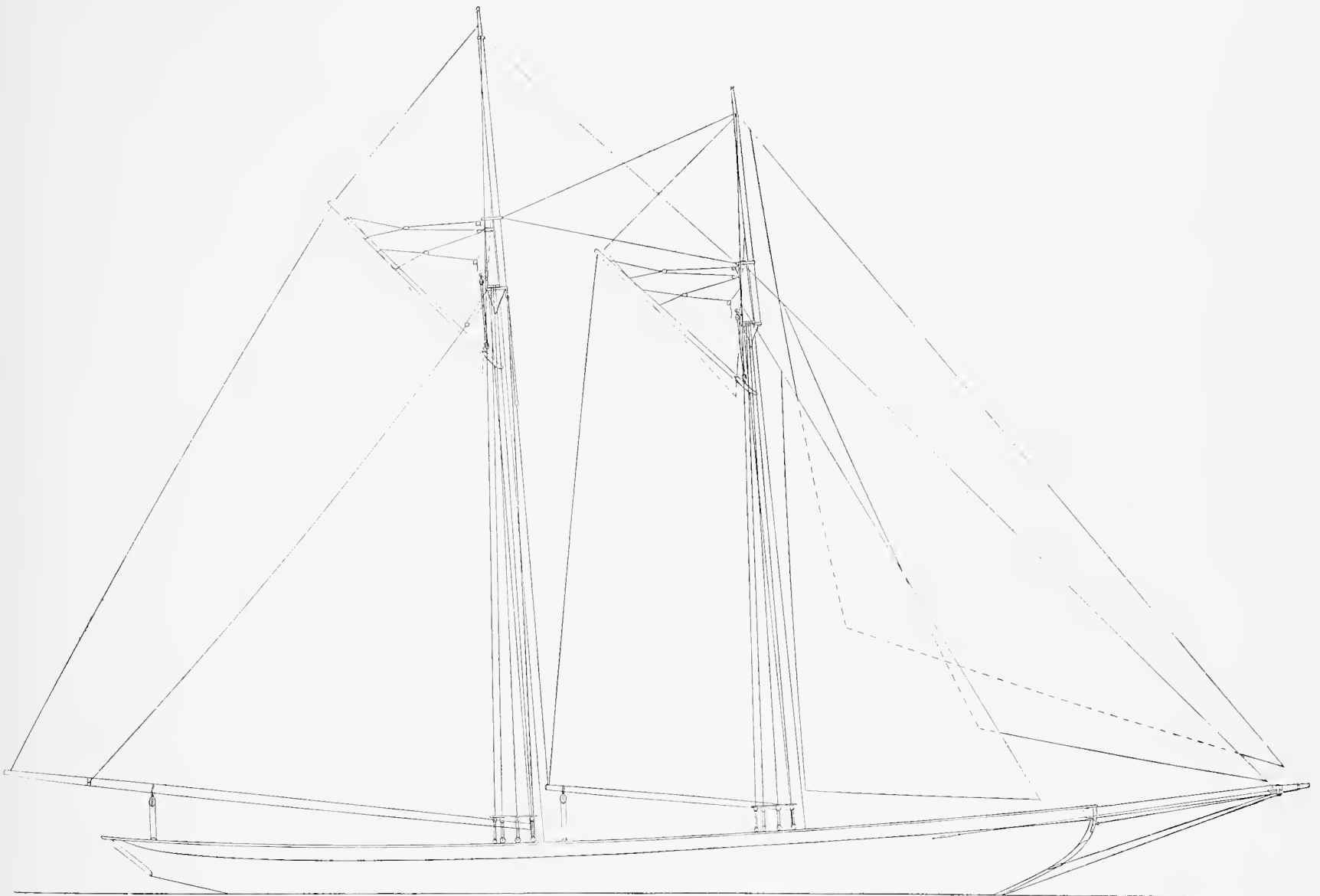

SAIL PLAN OF A MODERN PILOT BOAT.—Designed by A. Cary Smith, of New York, for Capt. T. B. Lasserre, of Fernandina, Fla.

that she was a much better sea boat than before, though he was opposed to the project at first. The explanation was that with the former short flat counter, the sea struck it with such force as to loosen the oakum. With the new stern the blow was received on a rounding form that raised the boat without the tremendous shock the old stern used to get. Again, the schooner *Lasca* proved what the modern type of yacht can do at sea. It is a remarkable fact that the old yachts rarely made a fast run when the weather was bad. When the sea got up they were obliged to "heave to," even though the wind might be favorable. All these points have been given careful consideration in the design of the Fernandina boat. First there is a

considerable drag to the keel and a good rake to the stern post. These features insure quick staying qualities. The mainmast is placed in the same relative position as that of the *Iroquois*, and as the center of buoyancy is in the same position, this boat will also "lay to" with a main trysail. To insure small head-sails, the forefoot has been well cut away as head sails give the most trouble at sea. The masts have considerable rake, as it was not deemed advisable for such a boat to carry runners as yachts do. The fore topmast is very short compared to the main topmast in order to carry a large jib topsail with the wind free during summer weather, and a small one will be carried to windward.

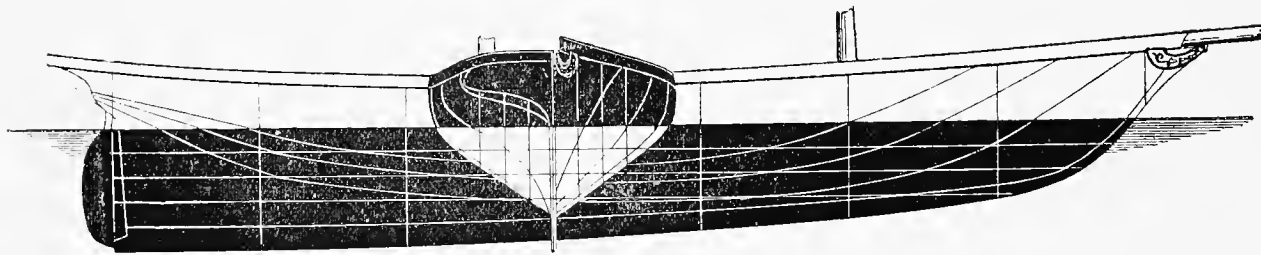

THE CELEBRATED SCHOONER YACHT AMERICA.

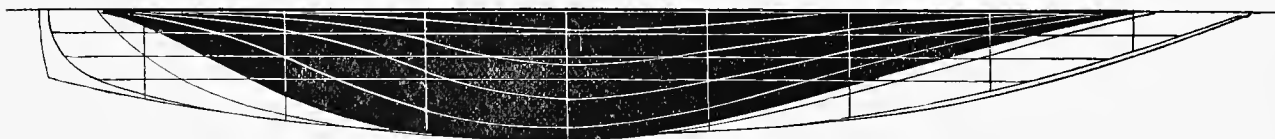
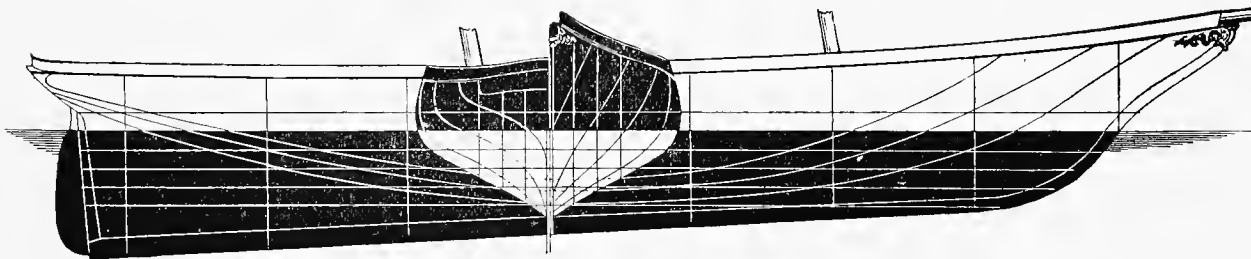

THE SWEDISH RACING SCHOONER YACHT SVERIDGE.

The Swedish Schooner Yacht Sveridge.

This remarkably fast schooner was built at Essinger, Sweden, by Carl A. Anderson, in 1852. She bears a strong resemblance to the America, which she raced off the Isle of Wight on October 12 of that year, outsailing the former for a long distance, but finally lost the race by the breaking of the jaws of her gaff. The general appearance of the two boats is so similar that we may assume that the designer of Sveridge has at least taken his inspiration from the American pilot boats, which have retained the same general type before and for a time after America. The dimensions of Sveridge were: Length over all, 113 feet 10 inches; load water line, 96 feet; beam, extreme, 25 feet 8 inches; load water line, 24 feet 8

inches; draught, 11 feet 8 inches; displacement, long tons, 149.5; area, midship section, square feet, 102.

The America.

The schooner yacht America was built in 1851, by George Steers, New York, for a syndicate headed by John C. Stevens, George L. Schuyler, and others. She was rigged precisely like a pilot boat of that day, with a single jib, a lug foresail, and no fore topsail. She had neither jib boom, fore topmast nor fore boom. Dimensions of hull: Length on deck, 94 feet; on water line, 88 feet; on keel, 82 feet; beam, 22 feet 6 inches; depth of hold, 9 feet 3 inches; draught of water, 11 feet 6 inches.

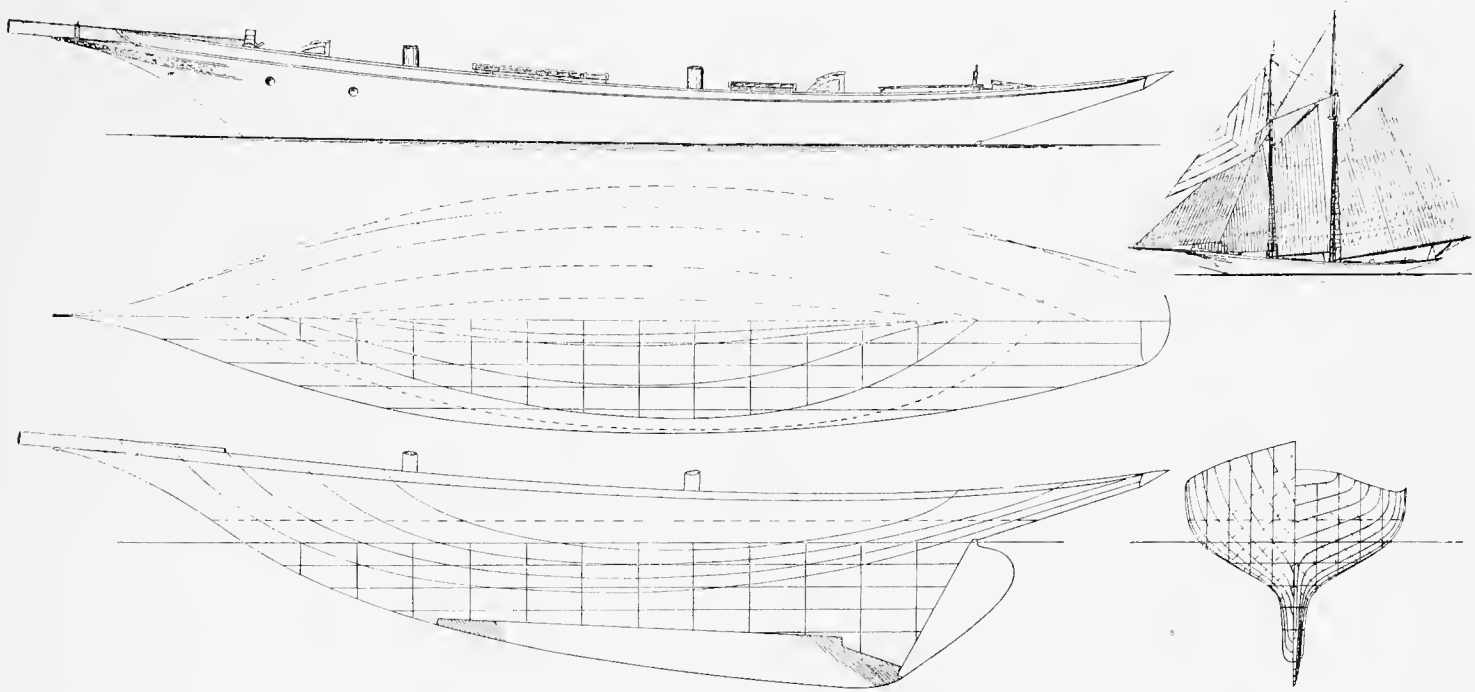

COMPOSITE SCHOONER YACHT.—Designed by Fred. W. Martin, Superintendent of the Racine (Wis.) Yacht and Boat Works.

A Combined Cruising and Racing Schooner.

The drawings shown herewith represent a 100-foot schooner yacht whose dimensions are as follows: Length over all, 100 feet; length, load water line, 65 feet; beam, extreme, 20 feet; draught, extreme, 13 feet; displacement, 68 short tons. Sail area: Mainsail, 2,472 square feet; foresail, 1,224 square feet; staysail, 624 square feet; jib, 525 square feet; total, 4,845 feet. The vessel is designed as a combined cruising and racing craft, and her interior will be fitted with two staterooms, captain's room, large saloon with six folding berths, galley, and large forecabin for crew. Her frame will be of composite construction, with single plank below load water line and double plank above. Decks of white pine laid fore-and-aft for holystone finish. All hatch coamings, companions, skylight frames, and everything above decks, will be of mahogany. The design is from the pen of Fred. W. Martin, of the Racine (Wisconsin) Yacht and Boat Works.

The Five-Masted Schooner Gov. Ames.

This vessel was built in 1888 by Leavitt Storer, at Waldoboro, Maine, and is 265 feet in length over all, 50 feet beam, and 21 feet 6 inches in depth of hold, drawing that draught of water. She is of 1,700 tons measurement, and has a carrying capacity of 3,000 tons of coal. She spreads 7,000 yards of canvas. Her owner is Capt. C. A. Davis, of Somerset, Mass.

Manton's Improved Windlass for Fishermen.

Up to 1856 the mercantile marine of this country handled their chains with a wooden windlass with three turns around it, operated by a beam. The chain had to be overhauled forward of the windlass before making port, and where the range was uncertain or unknown, a vessel was liable to go ashore before the matter could be rectified. Wooden pumps were in use, and a modern steering wheel was a novelty. In 1856 James Emerson brought out his iron windlass, which revolutionized the old method. A vessel could anchor with any range, with one or both anchors, without previous arrangement, and one or both anchors could be taken at once. Joseph P. Manton, of Providence, R. I., has since brought out many real improvements in this line, such as iron side bits, improved deck pipes, pump brake, windlasses, locking gear, taking anchor by direct steam windlasses, also from donkey, etc.

To meet the requirements of the fishing fleet, a windlass has been designed expressly for them which is stronger than any wooden windlass, and the anchor can be taken in one-half the time. The drum for the rope cable, and wildcat for the chain, are independent of each other. As the drum revolves and is easily controlled by a friction band, the cable will last much longer. In anchoring with the chain, it is only required to shackle the chain to the anchor, and the whole range is under control.

Some of the advantages that the new windlass possesses are, that it can be unlocked when under strain, its operation is

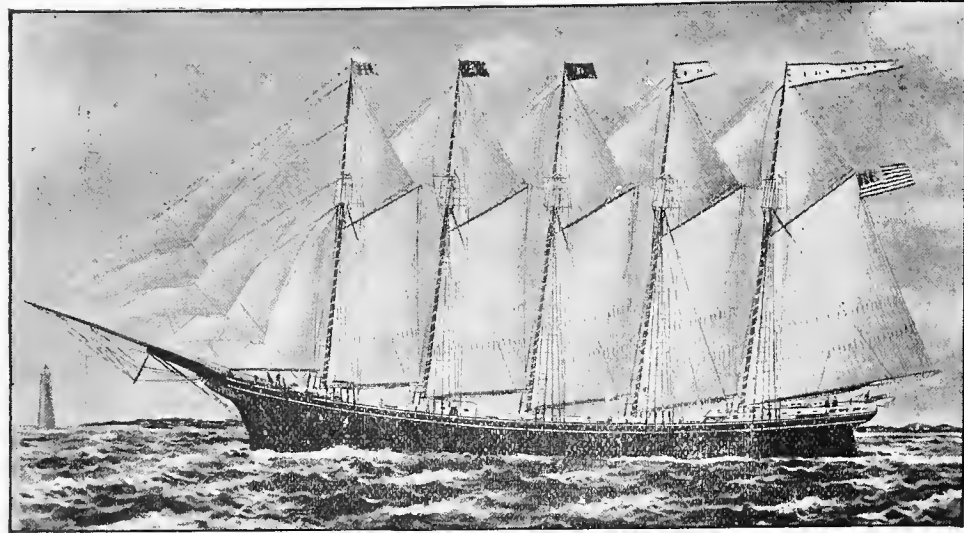
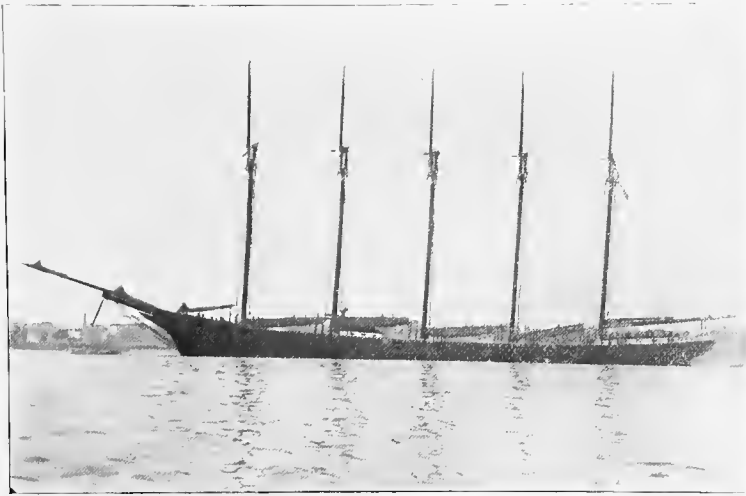

FIVE-MASTED SCHOONER GOV. AMES.—Built by Leavitt Storer, Waldoboro, Me.

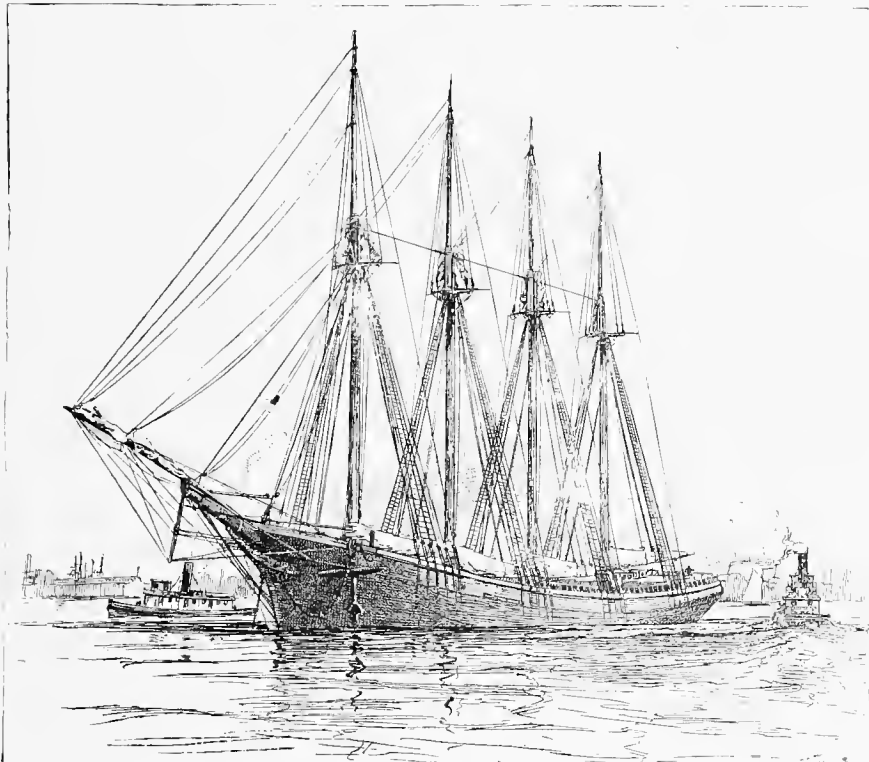

THE FOUR-MASTED WOODEN SCHOONER JOB H. JACKSON, JR.

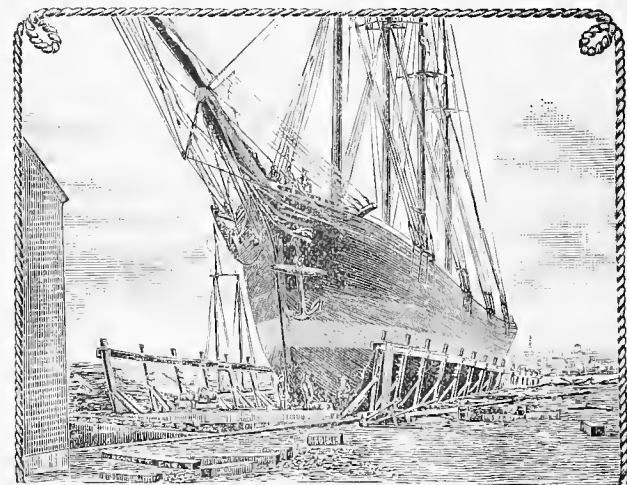

THE FOUR-MASTED WOODEN SCHOONER HAROLINE ON THE WAY

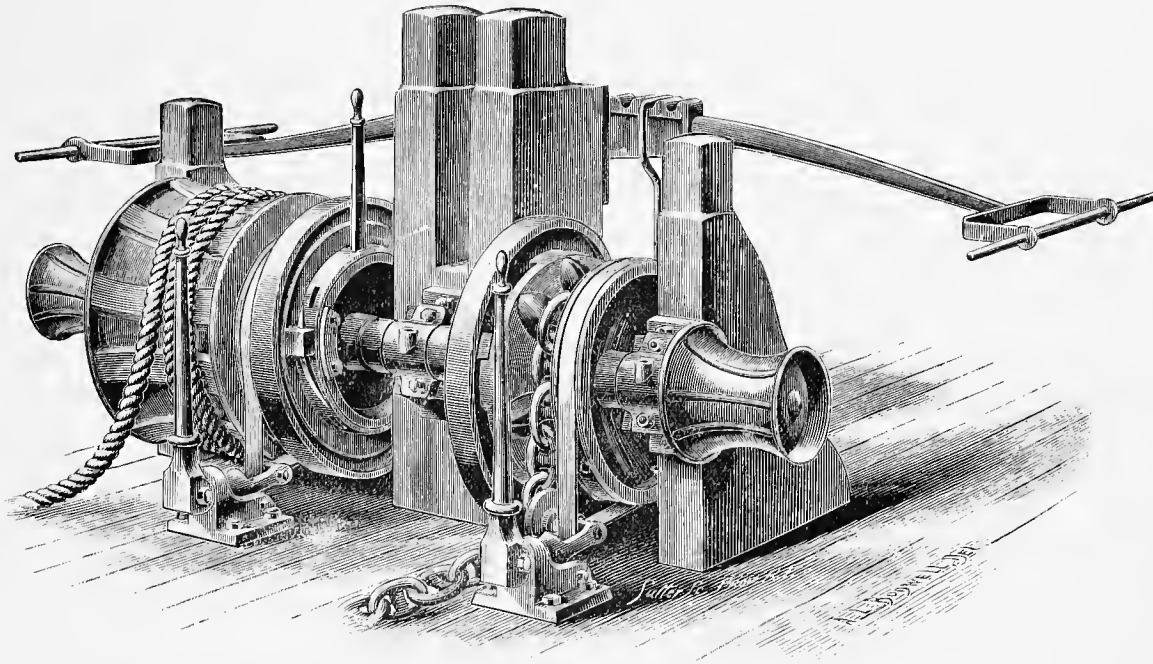

THE MANTON PATENT FISHERMAN'S WINDLASS.

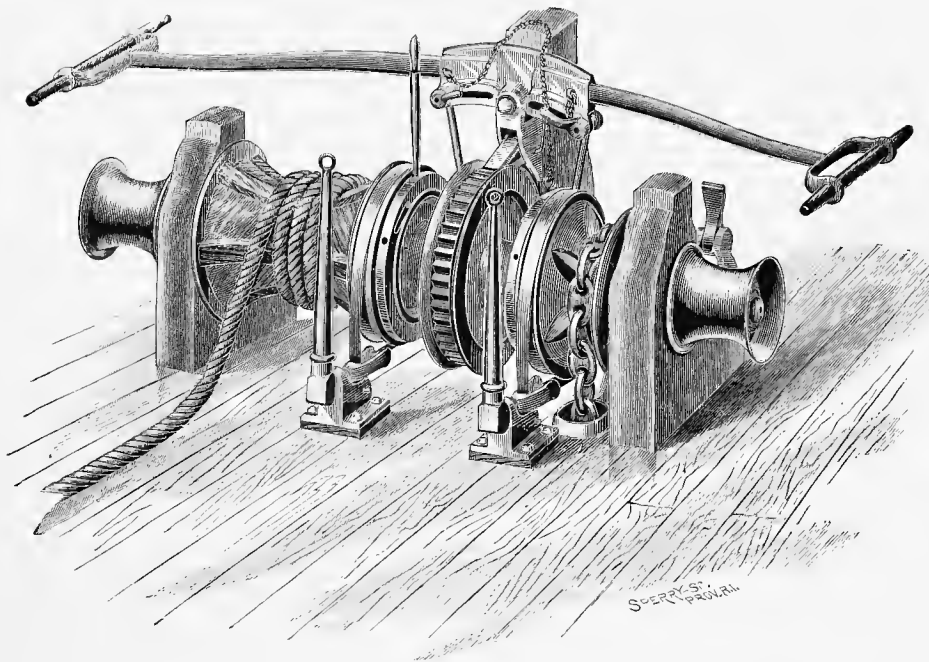

PROVIDENCE FISHERMAN'S WINDLASS.—Built by the American Ship Windlass Co.

entirely noiseless, there being no pawls ; it is light, but strong, and has a large range from speed to power, the change being quickly made.

By its use the life of cables is largely increased, a saving of some moment when their cost is considered. Special forms are made for steam or for using soft-cored wire rope.

The Providence Fisherman's Windlass.

The need of a windlass especially adapted to the requirements of fishing schooners, engaged in the cod and halibut fisheries, has long been felt. The Providence fisherman's windlass, built by the American Ship Windlass Company, of Providence, R. I., fills these requirements, as will be seen by reference to the engraving. The port side of this windlass is fitted with a wooden or iron barrel or drum to accommodate a manilla cable of from six to ten inches or even a foot in circumference, enough room being left between the welps of the windlass and the deck to allow the splices to pass clear at each 100 fathoms length, when the hawser is swollen beyond its natural size by being water-soaked. In this improved style the barrel or body of the windlass revolves with the cable while the latter is being paid out, and in this way prevents the wear and tear of rope caused by the friction of coming in contact with the sharp edges of the welps, which are bolted on the windlass body. The Providence pump-brake fisherman's windlass differs from, and is an improvement on, all other windlasses in regard to the barrel revolving in the direction of the cable when the anchor is let go. In this respect the manufacturers have accomplished something that was supposed to be impractical ; in fact, they have made an entirely new and original departure to in the workings of a windlass for fishing vessels. In addition the great saving in the wear and tear of the cable, brought about by this improved method, it is estimated that 500 fathoms of manilla cable, costing one dollar per fathom, will last at least half as long again by using the Providence windlass. In handling the anchors they can be weighed in half the time formerly occupied, as the windlass runs perfectly true and without any lost motion. The anchor can be dropped instantly, and after touching bottom the hawser will run out without any overhauling. The speed can be regulated by a hand at the brake. Three or four or even five turns of the hawser may be put round the windlass, so that in heaving the cable in, only one man is needed abaft the windlass to coil it away. In paying out the cable, this barrel revolves the same as a fishing reel, but is entirely under control of the man at the wheel or lever. The speed of either the cable or chain in running out over the "wild cat" on starboard side or the revolving drum on port side, is controlled by the friction band, which is actuated either by a lever or a small hand wheel, with or without spokes ; that is, if there is not room enough between the windlass and traveller boom to allow of a bar being used. The port side of this windlass can be worked independent of the starboard side, and *vice versa*, or both sides may be entirely disconnected from the main shaft which runs through from end to end, thus turning the windlass into a powerful winch, and leaving the ends free and clear for warping or hoisting purposes. The levers attached to the driving ratchet wheel are so arranged that they may be brought into the center of the working beam, thus procuring a double purchase for breaking out the anchor, after

which they can be slid out to the ends of the beam, giving a quick speed again for running the anchor up to the hawse pipe. On the starboard side the windlass is fitted with a wild cat or iron grabwheel, to take one inch chain (or any size desired), which will run from the chain locker on deck under an iron roller or pulley, placed abaft the windlass and over the wild cat, instead of having it come up from the locker below, directly under the windlass, as is the case on board of coasters and large vessels. The two iron pawls have an attachment by which they may be kept raised while the slack of the cable is being hove in, thereby making the windlass as noiseless as a silent-running sewing machine. This noiseless plan might be highly appreciated by the New England fishermen, who now stand in mortal dread of being pounced upon by a Dominion cruiser early in the morning, through making such a clatter "heaving short" before dawn. In heaving up an anchor with this improved windlass, only one side need be used, thus saving the power expended on the old type of wooden windlass in heaving round the dead weight of the side not in use, and it also saves the time used in trying up the chain on the starboard side. The arrangement of two iron pawls and one ratchet wheel accomplishes more than the old-fashioned windlass did with two wheels, besides giving a much stronger, more compact and convenient machine without any lost motion. The clamps on the new style windlass are made of heavy gun iron and the pawls of best forged Norway iron, so strong that they are capable of outlasting the vessel in all cases. This improved plan of handling ground tackle by means of the patent fisherman's windlass must steadily gain in favor with vessel owners and builders, as it is exceedingly valuable for the ease and rapidity of coming to an anchor and getting under weigh. The most important point gained by this inven-

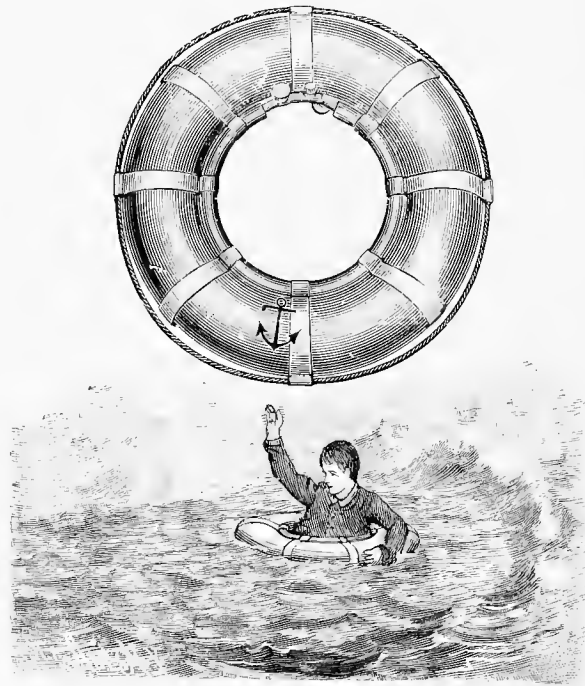

HOWELL'S SELF-ACTING RING BUOY.

tion is the saving in dollars and cents to the user of this improved windlass. Hawsers lasting a year, worked over the old windlass, will last at least eighteen months or two years on the one here represented, to say nothing of the time and labor saved by its use. The attention of owners and masters of our New England fishing fleet is especially invited to the foregoing. For descriptive catalogue address Frank S. Manton, Agent, Providence, R. I.

NOTE.—The improved Providence fisherman's windlass, as now built by the American Ship Windlass Co., differs slightly from that shown. The barrel, for one thing, being very much larger than that illustrated above.

Howell's Automatic Wave Lubricating Life Buoy.

The device consists of a ring buoy in the inner circle of which is placed a rubber tube, about one inch in diameter, which is filled with oil. Three or four inches from the ends of the tube there is inserted a light brass tube, small enough to fit snugly into the rubber, thus forming a tight joint. On either side of the brass tube there is fitted a brass rose (similar to that on a sprinkling can or watering pot), which is soldered to the former. There is also fitted a brass cap which is screwed into the metal tube, to be used for filling the rubber pipe with oil. When the buoy is hung at the stern or on the vessels' quarters,

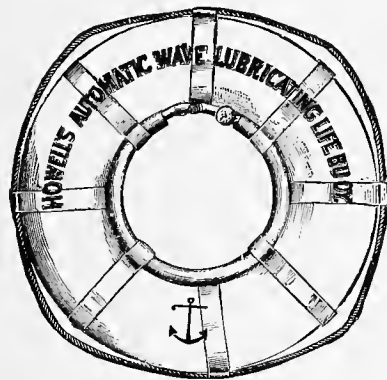

the oil cannot escape, but the moment the buoy is cut loose and thrown overboard, the oil automatically and instantaneously

commences to leak out of the roses, no matter which side of the buoy strikes the water. The most important feature of this invention is that a man may be seen, or rather, the smooth patch of water where he is may be kept in sight by those on board his vessel, even though she has run a couple of miles away before being brought up into the wind and hove to. Many men are drowned after falling overboard because the people on the ship lose sight of them before a boat can be lowered, but this simple and ingenious device proves an antidote to the turmoil going on all around, and provides an artificial mill pond, so to speak, where the mariner may float in safety until he is picked up. This device is the invention of G. Foster Howell, of the *American Shipbuilder*, but is owned and manufactured by D. Kahnweiler, 437 Pearl Street, New York.

Captain William Tunbridge.

Captain William Tunbridge, the proprietor of the Hotel St. George, of Brooklyn, N. Y., is a man "with a record," and that a most eventful and honorable one. He went to sea at thirteen years of age; at eighteen was mate of the ship *Veteran*, of Liverpool, and at twenty-one was a member of the American Shipmasters' Association. He was in the Federal Navy during the War of the Rebellion, and was one of the landing party which made the feint, drawing the fire of Fort Fisher, while the real attack was in the rear of the fort. In 1878 he commanded the clipper ship *Spartan*, which made the passage from New York to Havre in eighteen days (extraordinary time for a sailing vessel), and three years afterward, as captain of the steamship *Borrowdale*, he reached the head of the Gulf of Bothnia, in latitude 66°, the most northern point in the gulf ever attained by a steamship of that size until that time.

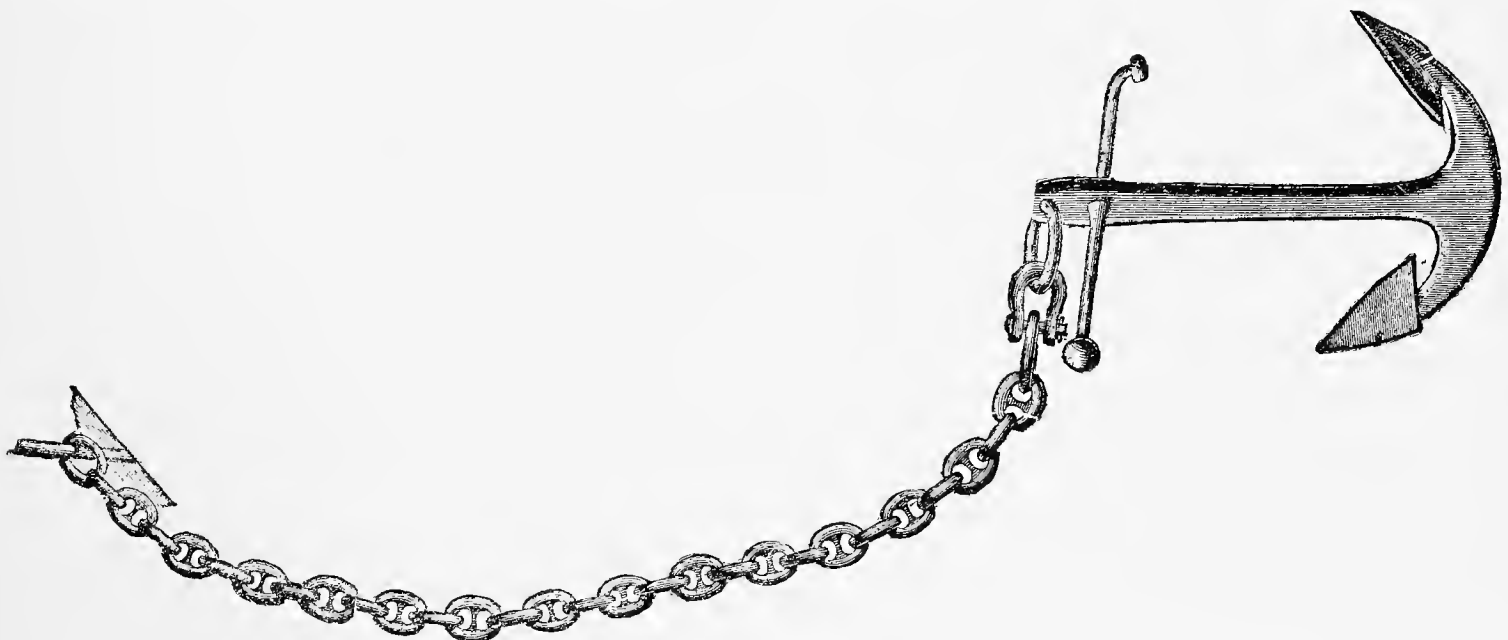

ANCHOR AND CABLE.



THE STAR-SPANGLED BANNER.



IN THE DOLDRUMS. A SHIP BECALMED.

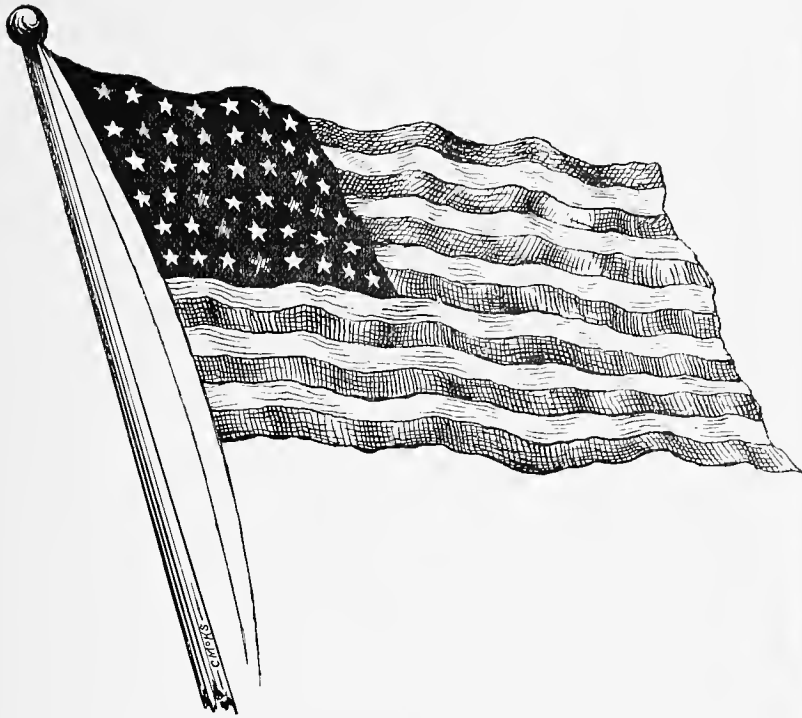

"OLD GLORY"—THE AMERICAN ENSIGN.



THE UNITED STATES FRIGATE CONSTITUTION—"OLD IRONSIDES."



THE UNITED STATES MAN-OF-WAR KEARSARGE.



THE AMERICAN SHIP GOVERNOR GOODWIN.

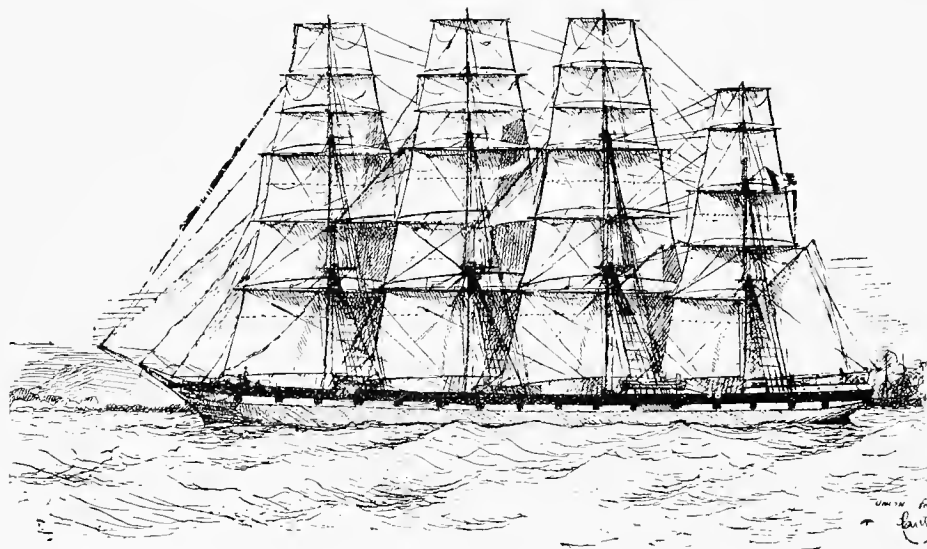

THE FRENCH FOUR-MASTED SHIP UNION.



TACKING SHIP OFF SHORE.

Tacking Ship off Shore.

THE weather leech of the topsail shivers ;
 The bowlines strain and the lee shrouds slacken ;
 The braces are taut and the lithe boom quivers,
 As the waves with the coming squall-cloud blacken.

Open one point on the weather bow,
 Is the lighthouse tall on Fire Island Head ;
 There's a shade of doubt on the Captain's brow,
 And the pilot watches the heaving lead.

I stand at the wheel, and with eager eye
 To sea and to sky and to shore I gaze,
 Till the muttered order of " Full and by " '
 Is suddenly changed to " Full for stays!"

The ship bends lower before the breeze,
 As her broadside fair to the blast she lays,
 And she swifter springs to the rising seas
 As pilot calls " Stand by for stays!"

It is silence all, as each in his place,
 With the gathered coil in his hardened hands,
 By tack and bowline, by sheet and brace,
 Waiting the watchword, impatient stands.

And the light on Fire Island Head draws near,
 As trumpet-winged the pilot's shout
 From his post on the bowsprit's heel I hear,
 With the welcome call of " Ready, about!"

No time to spare ; 'tis touch and go,
 And the Captain growls, " Down helm ! hard down!"
 As my weight on the whirling spokes I throw,
 While heaven grows black with the storm-cloud's frown.

High o'er the knightheads flies the spray,
 As we meet the shock of the plunging sea,
 And my shoulder stiff to the wheel I lay,
 As I answer, " Aye, aye, sir, hard a-lee!"

With the swerving leap of a startled steed
 The ship flies fast in the eye of the wind,
 The dangerous shoals on the lee recede,
 And the headland white we have left behind.

The topsails flutter, the jibs collapse,
 And belly and tug at the groaning cleats,
 The spanker slaps, and the mainsail flaps,
 And thunders the order, " Tacks and sheets!"

'Mid the rattle of blocks and the tramp of the crew,
 Hisses the rain of the rushing squall,
 The sails are aback from clew to clew,
 And now is the moment for " Mainsail haul!"

And the heavy yards, like a baby's toy,
 By fifty strong arms are swiftly swung ;
 She holds her way, and I look with joy,
 For the first white spray o'er the bulwarks flung.

" Let go and haul!" 'Tis the last command,
 And the headsails fill to the blast once more.
 Astern and to leeward lies the land,
 With its breakers white on the shingly shore.

What matters the reef or the rain or the squall,
 I steady the helm for the open sea ;
 The first mate clamors " Belay there all,"
 And the Captain's breath once more comes free.

And so off shore let the good ship fly,
 Little care I how the gusts may blow ;
 In my fo'castle bunk in a jacket dry,
 Eight bells have struck and my watch is below.



"LIKE A PAINTED SHIP ON A PAINTED OCEAN."



"TRIED AND TRUE."

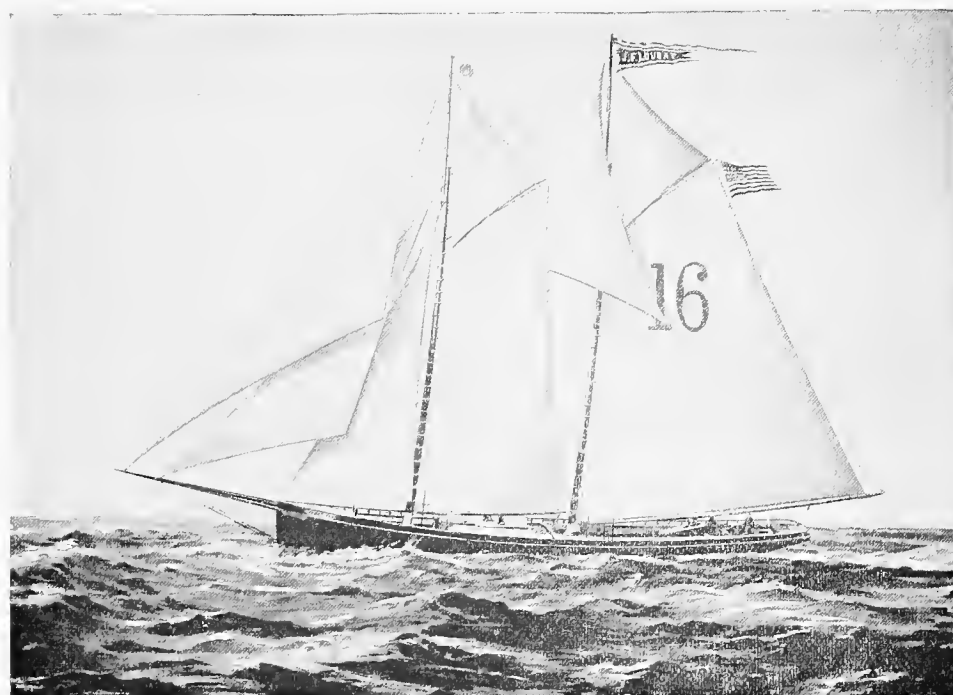

SANDY HOOK PILOT BOAT JAMES F. LOUBAT.

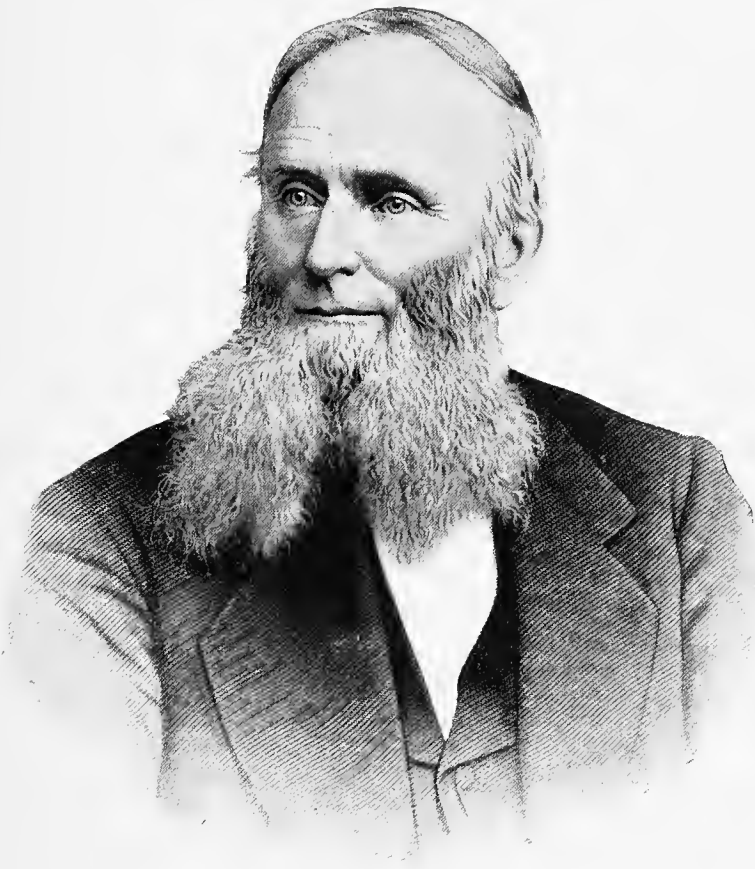

WILLIAM CRAMP.



WILLIAM H. WEBB.



JOHN ROACH.—Born on Christmas Day, 1813. Died, January 10, 1887.



CHARLES H. CRAMP.



J. C. HENDERSON.



GEORGE W. MELVILLE.



IRVING M. SCOTT.



CLEMENT A. GRISCOM.

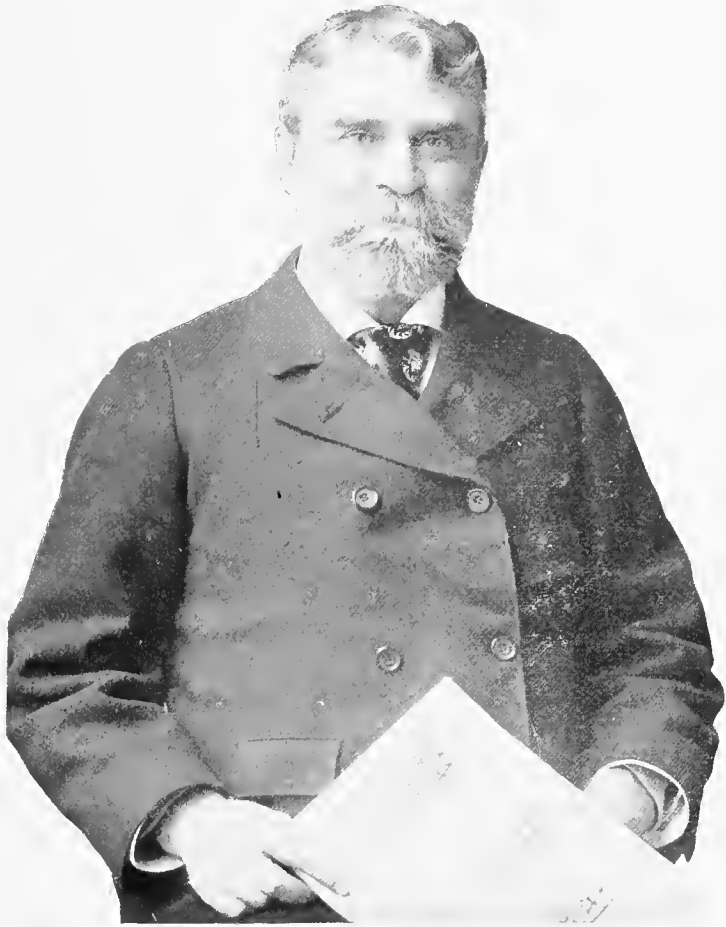

CAPT. GEO. J. NORTON.



GEO. W. DICKIE.



JOHN W. COLLINS.



W. T. SYLVÉN.

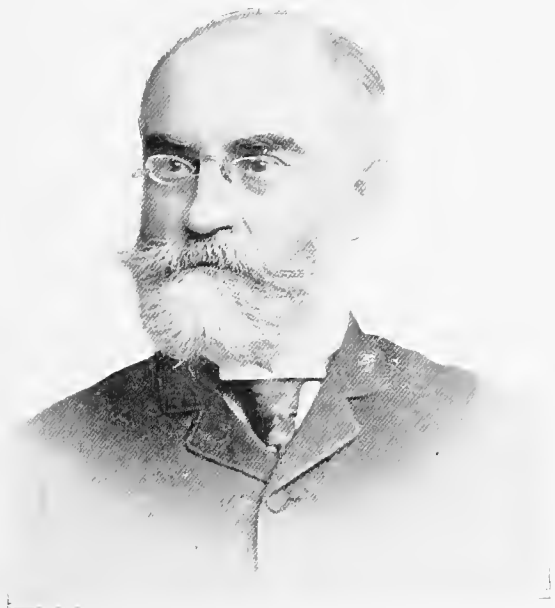

HORACE SEE.



W. H. JACQUES.



GEORGE V. SLOAT.



CHAS. D. MOSHER.



E. PLATT STRATTON.



SOMMERS N. SMITH.



PROF. W. F. DURAND.



JOHN HAUG



CHAS. R. HANSCOM.



FRANK B. KING.



DARWIN ALMY.



HENRY KONTZKY.



RICHARD P. JOY.



CHAS. B. MILLER.



CHARLES WARD.



E. E. ROBERTS.



CHARLES F. HYDE.



SINCLAIR STUART.



HOBERT CANFIELD.



SAMUEL J. CLARKE.



JAMES S. DORAN.



GEORGE CLARKE.



GUSTAV HILLMANN.



JOHN H. DIALOGUE



T. JACKSON SHAW.



JAMES DREDGE, OF MESSRS. MAW & DREDGE, EDITORS LONDON "ENGINEERING."



CAPT. I. J. MERRITT.



CAPT. WM. TUMBRIDGE.



PHILIP HICHBORN.

BOOKS OF REFERENCE

ON

MARINE ENGINEERING.



- | | |
|--|---|
| <p>Marine Propellers.
By Sydney W. Barnaby. 115 pages, 49 illustrations and 6 folding plates, 8vo., cloth \$4.25</p> | <p>Electric Lighting for Marine Engineers; or, how to light a ship by the Electric Light, and how to keep the apparatus in order.
By Sydney F. Walker, M.I.E.E. 293 pages, 134 illustrations, 12mo., cloth \$2.00</p> |
| <p>Screw Propellers and Marine Propulsion.
By I. McKim Chase. 230 pages, illustrated, 8vo., cloth 3.00</p> | <p>Useful Hints to Sea-going Engineers; and how to Repair and avoid breakdowns.
By W. H. Thorn. 203 pages, 36 illustrations and four folding plates, 12mo., cloth 1.40</p> |
| <p>The Boilermakers' and Iron Shipbuilders' Companion; comprising a series of original and carefully calculated Tables.
By James Foden. 4th edition, 222 pages, illustrated, 12mo., cloth 2.00</p> | <p>Practical Advice for Marine Engineers.
By Chas. W. Roberts, M.E. 150 pages, 64 illustrations, 12mo., cloth 1.00</p> |
| <p>Steamships and their Machinery from First to Last.
By J. W. C. Haldane, C.E. 532 pages, with folding plates, illustrations and plans, 8vo., cloth 6.00</p> | <p>Modern American Marine Engines, Boilers and Screw Propellers; their Design and Construction.
By Emory Edwards. 146 pages, illustrated, quarto, cloth 5.00</p> |
| <p>The Progress of Marine Engineering from the time of Watt until the present Day.
By T. Main, M.E. 248 pages, 67 illustrations, 12mo., cloth 3.00</p> | <p>Theoretical and Practical Ammonia Refrigeration. A work of Reference for Engineers and others employed in the management of Ice and Refrigeration Machinery.
By I. I. Redwood. 146 pages, 15 illustrations, 16mo., cloth 1.00</p> |
| <p>Steam Yachts and Launches; their Management and Making.
By C. P. Kunhardt. 267 pages, 160 illustrations, 8vo., cloth 3.00</p> | <p>A Manual of Marine Engineering; comprising the Designing, Construction and Working of Marine Machinery.
By A. E. Seaton. 585 pages, 147 illustrations and two folding plates, with numerous tables, 8vo., cloth 6.00</p> |
| <p>Submarine Boats.
By G. W. Hovgaard. 98 pages, 12 illustrations, and two large folding plates, 12mo., cloth 2.00</p> | <p>Reed's Engineers' Handbook of the Board of Trade Examinations for Certificates of Competency as First and Second-class Engineers.
By W. H. Thorn. In 2 vols: vol. I—text, 662 pages, 344 illustrations, 8vo., cloth; vol. II—36 large folding plates, complete 4.50</p> |
| <p>The Marine Transport of Petroleum. A Book for the use of Shipowners, Shipbuilders, Merchant Captains and Officers of Petroleum-Carrying Vessels.
By G. H. Little. 251 pages, 66 illustrations, 12mo., cloth 3.50</p> | |
| <p>Drawing of a Triple-Expansion Engine and the Pipe Arrangements.
On 2 sheets, each 40x25 inches, with index to Engine and Pipes, in cloth case 1.50</p> | |
| <p>Breakdowns at Sea, and how to Repair them.
By A. Richie Leask. 252 pages, 89 illustrations, 12mo., cloth 2.00</p> | |



Books mailed postpaid to any part of the world on receipt of published price. Descriptive circulars free.

SPON & CHAMBERLAIN,

Publishers of Books relating to Civil, Mechanical, Electrical, Mining and Marine Engineering,
the Industrial Arts, Trades and Manufactures.

Try our Sketching Paper. Send for sample.

12 CORTLAND ST., NEW YORK.

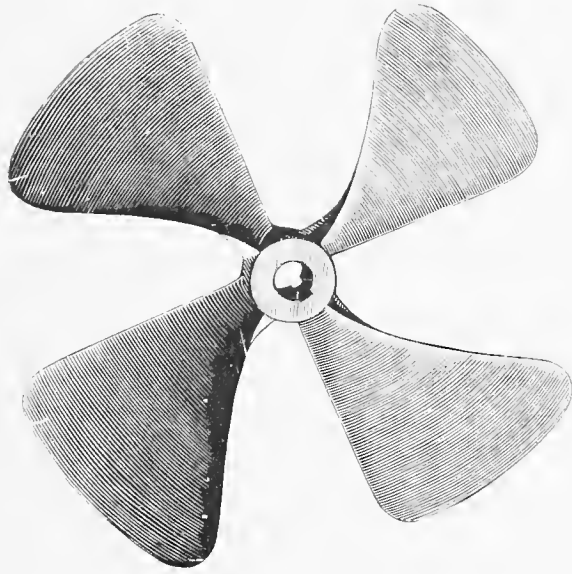

JOHN W. SULLIVAN,

BUILDER OF

COMPOUND AND TRIPLE-EXPANSION
MARINE ENGINES.

PROPELLER WHEELS A SPECIALTY.

384 AND 385 SOUTH STREET.
NEW YORK.

DAVID L. BRADLEY.

G. FOSTER HOWELL.

THE

AMERICAN SHIPBUILDER,

A Weekly Journal of Naval Architecture, Marine Engineering,
Commerce, Steam Navigation, Etc.

SUBSCRIPTION, \$2.00 PER YEAR, IN ADVANCE; \$3.00 TO FOREIGN COUNTRIES.
SINGLE COPIES, 10 CENTS. SAMPLE COPY, FREE.

BRADLEY & HOWELL, Editors and Proprietors,

7 Coenties Slip, New York.

